

Arboga Elektronikhistoriska Förening
www.aef.se 6552

PHILIPS

Tillhör
AM55



Function generator

PM 5167

9499 450 07102

760215/3/05/06



PHILIPS



Instruction manual
Gerätehandbuch
Notice d'emploi et d'entretien

Function generator
Funktionsgenerator
Générateur de fonctions

PM 5167



Contents

1.	GENERAL INFORMATION	7
1.1.	Introduction	7
1.2.	Technical data	8
1.3.	Accessories	10
2.	DIRECTIONS FOR USE	11
2.1.	Installation	11
2.1.1.	Safety regulations	11
2.1.2.	Controls and connectors	11
2.1.3.	Position	12
2.1.4.	Connection to the mains	12
2.1.5.	Earthing	12
2.2.	Operation	12
2.2.1.	Switching on	12
2.2.2.	Selecting the waveform	13
2.2.3.	Setting the frequency	13
2.2.4.	Setting the amplitude and d.c.-offset	13
2.2.5.	Square-wave signal output	13
2.2.6.	Frequency sweep	14
2.2.7.	Single-shot mode	15
2.2.8.	Hold function	15
3.	SERVICE MANUAL	37
3.1.	Description of the block diagram	37
3.1.1.	Description of the circuit diagram	37
3.1.2.	Oscillator unit U3	37
3.1.3.	Control unit U5	41
3.1.4.	Sine shaper-unit U4	43
3.1.5.	Power amplifier unit U6	43
3.1.6.	DC supply unit U7	44
3.2.	Gaining access to the parts	45
3.3.	General check, adjusting and checking	46
3.4.	Hints for fault finding	52
3.5.	Parts List	53

LIST OF FIGURES

	11
1. Front view, controls and connectors	11
2. Rear view, controls and connectors	12
3. Connection diagram for the different mains voltages	14
4. Sweep range PM 5167	15
5. Starting points for the various signals in the SINGLE SHOT mode	38
6. Block diagram of the generator	39
7. Block diagram of the oscillator U3	39
8. Principle of the current mirror	39
9. Graph of amplitude response and rise time	49
10. Adjusting elements on UNIT 2	49
11. Adjusting elements on UNIT 2 up to UNIT 7	54
12. Front view, mechanical components	54
13. Rear view, mechanical components	54
14. Top view, mechanical components	54
15. Bottom view, mechanical components	68
16. Printed-wiring board U7	69
17. Circuit diagram of the power supply U7	70
18. Printed-wiring board U1	70
19. Printed-wiring board U2	71
20. Printed-wiring board U3	71
21. Printed-wiring board U4	72
22. Printed-wiring board U5	72
23. Printed-wiring board U6	73
24. Overall circuit diagram PM 5167	

Inhalt

1.	ALLGEMEINER TEIL	17
1.1.	Einleitung	17
1.2.	Technische Daten	18
1.3.	Zubehör	20
2.	GEBRAUCHSANLEITUNG	21
2.1.	Inbetriebnahme	21
2.1.1.	Sicherheitshinweise	21
2.1.2.	Anschluss- und Bedienungselemente	21
2.1.3.	Aufstellung	22
2.1.4.	Netzanschluss	22
2.1.5.	Erdung	22
2.2.	Bedienung	22
2.2.1.	Einschalten	22
2.2.2.	Wahl der Signalformen	23
2.2.3.	Frequenzeinstellung	23
2.2.4.	Einstellung von Amplitude und DC-Offset	23
2.2.5.	Rechtecksignalausgang	23
2.2.6.	Frequenzsweep	24
2.2.7.	SINGLE SHOT-Betrieb	25
2.2.8.	Haltefunktion	25

BILDVERZEICHNIS

1.	Frontansicht, Bedienungselemente und Anschlüsse	21
2.	Rückansicht, Bedienungselemente und Anschlüsse	21
3.	Anschluss-Schaltbild für die verschiedenen Netzspannungen	22
4.	Sweepbereich PM 5167	24
5.	Startpunkte der verschiedenen Signale im "SINGLE SHOT" Betrieb	25

Table des matières

1.	GENERALITES	27
1.1.	Introduction	27
1.2.	Caractéristiques techniques	28
1.3.	Accessoires	30
2.	MODE D'EMPLOI	31
2.1.	Installation	31
2.1.1.	Règles de sécurité	31
2.1.2.	Bornes et réglages	31
2.1.3.	Position	32
2.1.4.	Raccordement au secteur	32
2.1.5.	Mise à la terre	32
2.2.	Mode d'emploi	32
2.2.1.	Mise en service	32
2.2.2.	Sélection de la forme d'onde	33
2.2.3.	Réglage de fréquence	33
2.2.4.	Réglages d'amplitude et d'offset continu	33
2.2.5.	Sortie de signal rectangulaire	33
2.2.6.	Balayage en fréquence	34
2.2.7.	Mode monocoup	35
2.2.8.	Fonction maintenue	35
FIGURES		
1.	Vue de face	31
2.	Vue arrière	31
3.	Schéma de branchement pour différentes tensions d'alimentation	32
4.	Gamme de balayage	34
5.	Points de départ pour les signaux en mode "single shot"	35

Operating manual

1. General information

1.1. INTRODUCTION

The function generator PM 5167 has a wide frequency range (1 mHz ... 10 MHz) and an extremely high output voltage (40 V_{pp} open circuit). Furthermore it has a wide variety of waveforms; sine-, triangular-, square wave, sawtooth-, and pulse signals.

Excellent specifications, features like e.g. sweep input, single shot mode with adjustable start phase, hold, DC-offset and a compact construction make the PM 5167 a versatile tool for electronic laboratories, production and engineering design groups.

Other features are:

- Overrange indication
- Frequency offset control
- Control input (at the rear)
- 20 dB attenuation

The following outputs are provided:

- One output terminal from which any one of the waveforms can be selected with variable amplitude, d.c. level and frequency offset.
- One output terminal from which a square-wave signal can be taken with a fixed amplitude, symmetrical to zero, adjustable frequency and selectable mark-space ratio.

1.2. TECHNICAL DATA







General instructions

- a.c. voltages are, if not quoted otherwise, stated as r.m.s. values
- only values with tolerances or limits of error apply as guaranteed data
- relative faults (in per cent or ppm) relate to the adjusted value
- all specifications will met after a warming-up period of 30 minutes

Frequency

Range	: 1 mHz ... 10 MHz in ten sub-ranges of one decade
Setting	: by means of step-switch 1 m, 10 m, 0.1 ... 1 M
Adjustment	: continuous, by 3 turns knob and linear scale
Offset	: -5% ... $\pm 5\%$ relative variation
Accuracy	
1. time symmetrical waveforms	: $\pm 6\%$ in range 1 m $\pm 5\%$ in range 10 m $\pm 2\%^*$ in range 0.1 to 10 k $\pm 3\%^*$ in range 100 k $\pm 4\%^*$ in range 1 M
2. time asymmetrical waveforms	: $\pm 8\%$ in range 1 m $\pm 7\%$ in range 10 m $\pm 3\%^*$ in range 0.1 to 10 k $\pm 4\%^*$ in range 100 k
Temperature coefficient	: $< 0.3\%/^{\circ}\text{C}$ up to 8 MHz
Long-term drift	: $< 0.2\%$ in 7 hours after a warming-up period of 4 minutes at a constant temperature of 25°C
Frequency variation	: < 50 ppm at nominal mains voltage $\pm 10\%$

Waveforms

Sine wave	: 
Square wave	:  , duty cycle 0.5
Triangular wave	: 
Sawtooth	:  , duty cycle 0.1 up to 1 MHz  , duty cycle 0.9 up to 1 MHz
Pulse	:  , duty cycle 0.9 up to 1 MHz  , duty cycle 0.1 up to 1 MHz

Outputs

1. With selectable waveform	
AC voltage	: max. $40 V_{pp}$ (open circuit)
DC-offset	: $0 \dots \pm 10$ V
Impedance	: 50Ω
Attenuation	: Continuous > 30 dB 1 Step, 20 dB
Rise/fall time of square wave	: < 25 ns up to $10 V_{pp}$ < 30 ns up to $20 V_{pp}$

* $\pm 0.2\%$ of maximum range value

Max. load	: permanent short circuit proof
2. Square wave with fixed amplitude	
Output voltage	: $2 V_{pp}$ (open circuit)
Impedance	: 50Ω
Rise/fall time	: $< 18 \text{ ns}$
Max. load	: Permanent short circuit proof
Ramp linearity error (in frequency range 1 mHz ... 100 kHz)	: $< 1 \%$ up to $40 V_{pp}$ $< 0.25 \%$ up to $4 V_{pp}$
Frequency response	
Up to 10 kHz	: $\pm 1 \%$ for all waveforms
Up to 100 kHz	: $\pm 3 \%$ for sine wave $\pm 6 \%$ for triangle, sawtooth
Up to 1 MHz	: $\pm 3 \%$ for sine wave $\pm 10 \%$ for triangle, sawtooth
Up to 10 MHz	: $\pm 10 \%$ for all waveforms
Distortion of sine wave	
1 mHz ... 1 Hz	: $< 1 \%$
1 Hz ... 10 kHz	: $< 0.5 \%$
10 kHz ... 100 kHz	: $< 1.0 \%$
100 kHz ... 1 MHz	: $< 2.0 \%$
1 MHz ... 10 MHz	: $< 5.0 \%$
Special functions	
<i>Frequency control</i>	: Via SWEEP input, max. 3 decades with linear relationship between voltage and frequency $10 \text{ V}/3 \text{ decades}$
Input impedance	: $1 \text{ k}\Omega$
Max. permissible voltage	: $\pm 15 \text{ V}$
<i>Hold</i>	
Frequency range	: 1 mHz ... 10 Hz
Operation	: via Hold/Run switch via CONTROL INPUT in switch position RUN
Input voltage for electronic HOLD	: +5 V, to CONTROL INPUT
Input resistance	: $10 \text{ k}\Omega$
Max. permissible voltage on CONTROL INPUT:	$\pm 10 \text{ V}$

SINGLE SHOT mode

Frequency range	: 1 mHz ... 1 kHz
Triggering	: by means of switch OFF/SET PHASE/START in position START Via a negative pulse of 5 V, fall time < 1 μ s, on CONTROL INPUT
Selection of start point	: by means of control SET PHASE
Position of start point	: on the positive going ramp for triangle and sawtooth signals on the negative going side of the sine wave, adjustable between the negative and positive peak-value
Input resistance of CONTROL INPUT	: 10 k Ω
Max. permissible voltage on CONTROL INPUT	: ± 10 V
Overrange indication	: Lamp OVERRANGE indicates when due to positions of DC and AC controls clipping in the output amplifier may occur
Controlled values	: ± 20 V (open circuit), attenuator in position 0 dB ± 2 V (open circuit), attenuator in position -20 dB

Mains supply

Voltage	: 110, 128, 202, 220 and 238 V ± 10 %
Frequency	: 47.5 Hz ... 105 Hz
Consumption	: max. 52,3 W
Temperature range	: 5 ... 40 $^{\circ}$ C

Environmental conditions

Reference temperature	: 23 $^{\circ}$ C
Normal operating temperature	: +5 to +40 $^{\circ}$ C
Temperature range for transport and storage	: -40 to +70 $^{\circ}$ C
Operating position	: horizontal, ± 30 $^{\circ}$ C

This instrument conforms to VDE 0411 class I, protection standard

Dimensions (over all)	height	145 mm
	width	230 mm
	depth	285 mm
Weight	: 7.5 kg	

1.3. ACCESSORIES**Standard accessories**

- Operating manual

Optional accessories (to be ordered separately)

- Termination, 50 Ω , 3 W PM 9581
- Coaxial cable, BNC-BNC PM 9075

2. Directions for use

2.1. INSTALLATION

2.1.1. Safety regulations (in accordance with IEC 348 or VDE 0411)

Before using the instrument after stocking and transport, pay attention that the instrument has not been mechanically damaged.

If there is a doubt about the efficiency of the protection, check this.

If the protection is no longer guaranteed, disconnect the instrument from the mains and make it inoperative. The instrument must be disconnected from the mains before opening.

Maintenance and service works, which must be done with the instrument switched on, should only be performed by qualified personnel.

The mains connector may be plugged only into a mains socket with earth contacts. This safety measure may not be made inoperative, e.g. with an improper extension cable.

2.1.2. Controls and connectors

(see fig. 1 and fig. 2)

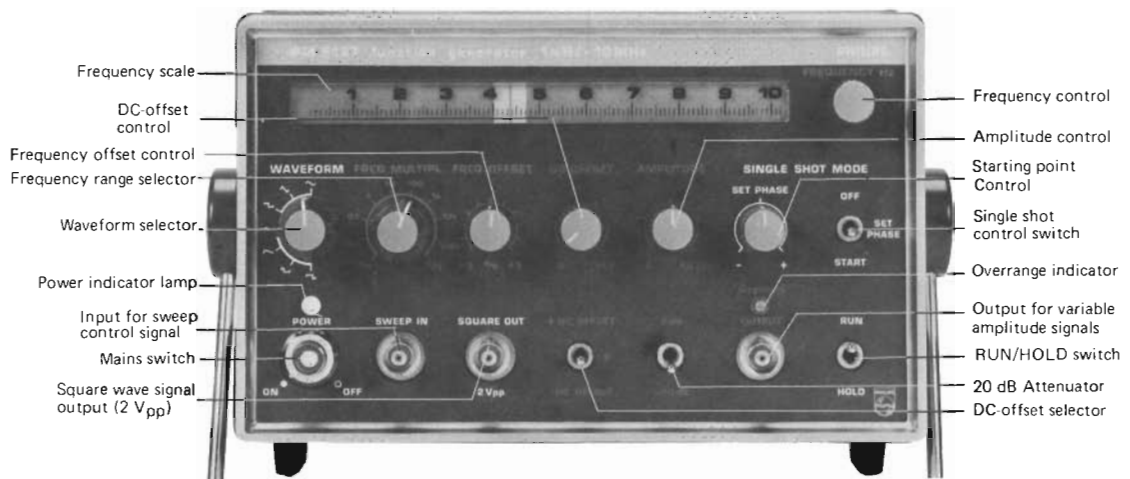

Fig. 1. Front view, controls and connectors.

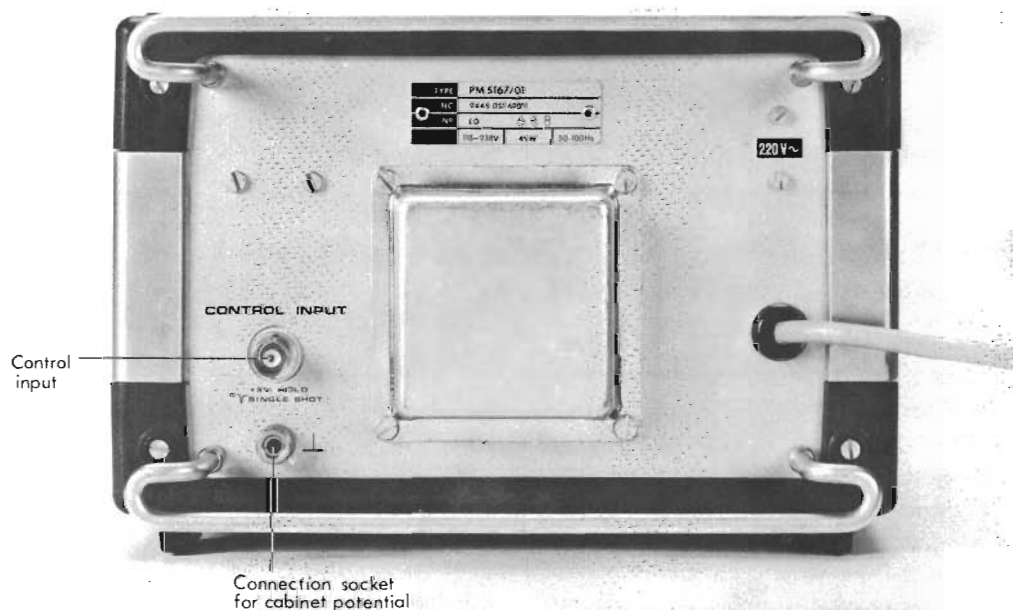

Fig. 2. Rear view, controls and connectors.

2.1.3. Position

The instrument must be positioned horizontally or on one edge by using the tilting bracket.

The ventilation openings in bottom- and top plate must not be covered.

Pay attention that the instrument is not positioned on objects which produce heat or radiate excessive heat.

2.1.4. Connection to the mains

The instrument must only be supplied with a.c. voltage. On delivery the instrument is set to 220 V \pm 10 %.

If it must be used on different mains voltage, proceed as follows:

- Plug off the mains plug
- Remove the base plate after removing both screws at the rear
- Alter the circuitry of the primary in accordance to schedule Fig. 3.
- Close the base plate and remove the cover
- Exchange the mains-voltage indication plate on the rear side in accordance with the selected mains voltage
- Close the instrument.

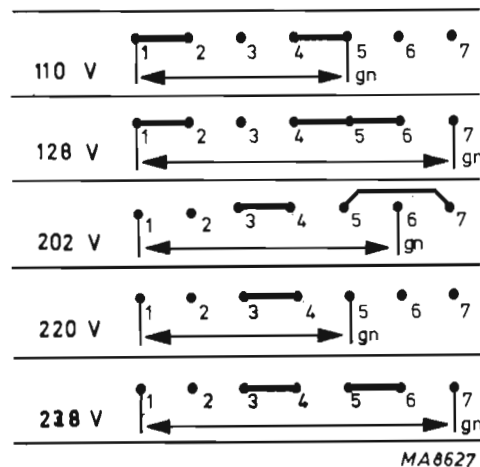

Fig. 3. Connection diagram for the different mains voltage

2.1.5. Earthing

The protective earth of the generator must be in conformity with the local safety regulations. The mains cable of the instrument contains a protective conductor connected to the earth contacts of the plug. This plug must be connected to a mains socket with earth contacts. The protective earthing of the instrument is only guaranteed when performed in this way.

The cabinet socket (⏚) at the rear must not be used to connect a protective earth conductor.

The signal-zero potential of the generator (that of the outer contacts of all BNC connectors) is connected to the cabinet by means of a capacitor and a resistor connected in parallel. A proper HF-earthing of the circuit is then obtained.

2.2. OPERATION

Note:

When **NOT** operating the instrument in the SINGLE SHOT or HOLD modes take care that in the frequency ranges 1 m ... 100 for mode SINGLE SHOT, and 1 m ... 1 for mode HOLD the switches OFF/SET PHASE/START and RUN/HOLD are in the positions OFF and RUN respectively, otherwise there will be no signal at socket OUTPUT.







2.2.1. Switching-on

Connect the generator to the mains according to 2.1.4. and switch on the instrument by pressing mains switch POWER.

The relevant pilot lamp then lights, indicating that the instrument is ready for use. The white part in the power switch indicates mechanically that the instrument is switched on.

2.2.2. Selecting the waveform

The required waveform can be selected by means of the WAVEFORM switch.

The scale of this switch is divided in two ranges. One range comprises the time-symmetrical signals (, , ) while the other comprises the time-asymmetrical signals (, , , ).

The signal with the selected waveform is available at the BNC-socket OUTPUT.

Attention: For time-asymmetrical, the upper frequency limit is 1 MHz and is obtained in position 100 k of the frequency-range switch FREQ. MULTIPL.

2.2.3. Setting the frequency

The frequency can be set by three different controls:

1. frequency control FREQUENCY Hz with linear scale
2. frequency-range selector FREQ. MULTIPL.
3. frequency-offset control FREQ. OFFSET

The required nominal frequency is set by the frequency control and frequency range selector, while the frequency-offset control must be kept at zero (mid-position). The output frequency equals the product of the reading of the linear scale and the multiplier factor of the frequency-range selector (example: scale reading 1.9 x range selector 10 k = output frequency 19 kHz).

A frequency increment of $\pm 5\%$ of the set value can be set by means of the frequency-offset control.

2.2.4. Setting the amplitude and d.c.-offset

The signal amplitude at BNC socket OUTPUT can be set either continuously by control AMPLITUDE or/and by step-attenuator 0 dB/−20 dB.

If the attenuator is set to 0 dB, the amplitude control covers a range up to $40 V_{pp}$. However, if the attenuator is set to −20 dB, output voltages up to $4 V_{pp}$ are obtainable. A d.c. voltage can be added to the output signal by means of selector +DC OFFSET/0/−DC OFFSET and potentiometer DC OFFSET. In position 0 of the selector the d.c. offset is cut off, while the polarity is selected by its two other positions. The offset voltage can be set continuously between 0 and 10 V by the offset control.

Indicator OVERRANGE shows that overdriving of the output amplifier will occur due to simultaneous settings of both AMPLITUDE and DC OFFSET controls when an excessive voltage is fed into the amplifier.

The overrange pilot lamp will already light at this particular settings when there is no signal at the OUTPUT terminal, e.g. before releasing a single shot. The output voltage limits of the sum of selected signal and DC-offset, monitored by the overrange indicator, are ± 20 V with the step attenuator at 0 dB and ± 2 V with the step attenuator at −20 dB.

2.2.5. Square-wave signal output

At output SQUARE OUT the generator delivers a square-wave signal of $2 V_{pp}$ symmetrical to zero. The frequency equals the set frequency. The duty cycle depends on the selected signal form. For signals symmetrical to time, the duty cycle is 0.5 and for signals non-symmetrical to time it is 0.1 or 0.9 respectively.

2.2.6. Frequency sweep

The frequency of the generator can be controlled by supplying a control signal to input SWEEP IN. The frequency changes linearly with the control voltage as a function of

$$f_o = m \left(n_s + \frac{U_c}{V} \right) \text{ Hz, when } 0 < \left(n_s + \frac{U_c}{V} \right) < 10$$

f_o = signal frequency at the generator output

m = factor set at frequency-range selector (10^{-3} , 10^{-2} ... 10^6)

n_s = numerical value set at the linear scale (0.01 ... 10)

U_c = control voltage at input SWEEP IN

Any range up to three decades out of the overall frequency range of the instrument can be covered by external sweeping (see fig. 4). To avoid frequency- and phase jitter, which may be caused by extremely low interference voltages on the sweep control signal, it is recommended when sweeping over more than one decade to set the generator (according to 2.2.3.) to the lowest frequency desired and to cover the entire sweep range by a control signal of positive polarity.

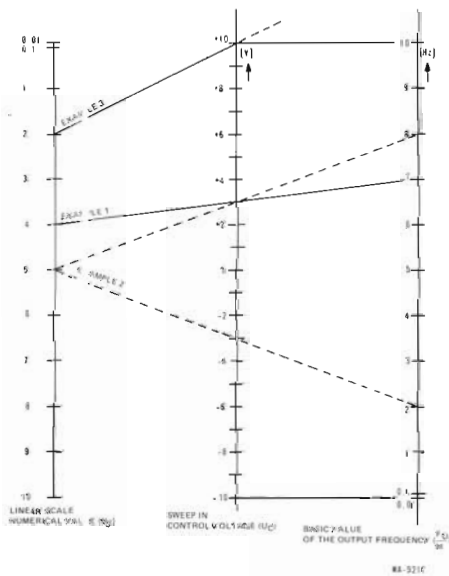

- | | | |
|------------|-------------------------------|----------------------|
| Example 1: | Scale set to | 4 |
| | Control voltage on SWEEP IN | + 3 V |
| | Output frequency | (7 x range m) Hz |
| Example 2: | Scale set to | 5 |
| | Control voltage on SWEEP IN | ~ 6 V _{pp} |
| | Sweep of the output frequency | (2 ... 8x range m)Hz |
| Example 3: | Scale set to | 2 |
| | Control voltage on SWEEP IN | + 10 V |
| | Output frequency | not defined |

Fig. 4 Sweep range PM 5167.

2.2.7. Single-shot mode

The generator is provided with a control device which can produce single periods of a signal with set frequency and signal form. The single shot capability is operative for all signal forms and in the frequency ranges 1 m ...1k. The starting point can be set continuously between the peak values of the signal (in accordance with Fig. 5) by means of potentiometer SET PHASE.

To this end proceed as follows:

- Select the signal form (2.2.2.)
- Set the frequency (2.2.3.)
- Set the signal amplitude and d.c. -offset (2.2.4.)
- Set the control switch to SET PHASE
- Set potentiometer SET PHASE in accordance with Fig. 5. to the required starting point
- Release single period by pressing control switch OFF/SET PHASE/START to position START

A single period can also be released by applying a negative-going pulse from 0 to -5 V with a fall time $< 1 \mu\text{s}$ to CONTROL INPUT (rear side).

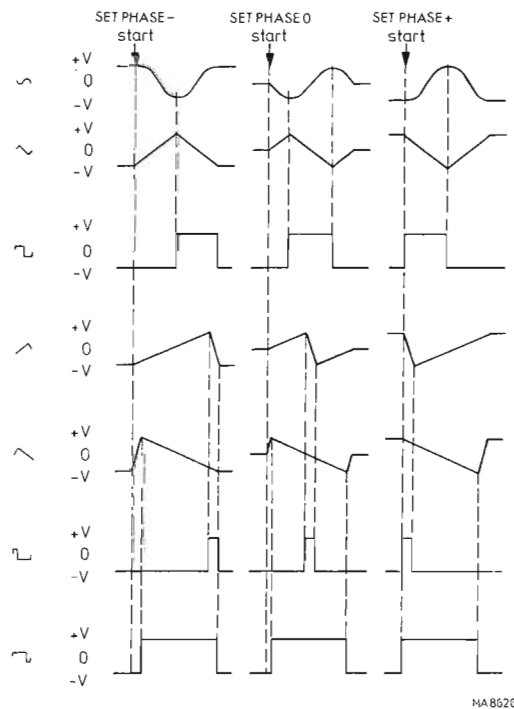

Fig. 5. Starting points for the various signals in the "SINGLE SHOT" mode

2.2.8. HOLD function

The output signal can be kept at its instantaneous voltage by either setting the switch RUN/HOLD to position HOLD or by applying a d.c. voltage of $+5$ V to CONTROL INPUT (rear side). The HOLD function is only effective in positions 1 m ... 1 of the frequency range selector.

Bedienungsanleitung

1. Allgemeiner Teil

1.1. EINLEITUNG

Der Funktionsgenerator PM 5167 besitzt einen breiten Frequenzbereich (1 mHz ... 10 MHz) und eine besonders hohe Ausgangsspannung (40 V Spitze - Spitze im Leerlauf). Ausserdem liefert das Gerät viele verschiedene Signalformen; Sinus-, Dreieck-, Rechteck-, Sägezahn- und Pulssignale.

Ausgezeichnete Spezifikationen, Eigenschaften wie z.B. Sweepeingang, einmalige Auslösung mit einstellbarer Startphase, Haltefunktion, DC-Offset und kompakte Konstruktion machen den PM 5167 zu einem vielseitigen Gerät geeignet zur Anwendung im Elektroniklabor, in der Fertigung und bei technischen Entwicklungsgruppen.

Andere Eigenschaften sind:

- "Ovrange"-Anzeige
- Frequenz-Offset Steuerung
- Steuereingang (an der Rückseite)
- 20 dB Abschwächung

Folgende Ausgänge sind vorhanden:

- Ein Ausgangsanschluss an dem eine der Signalformen mit variabler Amplitude, Gleichspannungspegel und Frequenz-Offset gewählt werden kann.
- Ein Ausgangsanschluss, dem sich ein Rechtecksignal mit fester Amplitude, symmetrisch gegen Null, mit einstellbarer Frequenz und wählbarem Tastverhältnis, entnehmen lässt.

1.2. TECHNISCHE DATEN

AI allgemeine Hinweise

- Wechselspannungen, wenn nicht anders erwähnt, sind als Effektivwerte angegeben.
- nur Werte mit Toleranzen oder Fehlergrenzen gelten als garantierte Daten
- relative Fehler (in % oder ppm) beziehen sich auf den eingestellten Wert
- alle Spezifikationen gelten nach einer Einlaufzeit von 30 Minuten.







Frequenz

Bereich	: 1 mHz ... 10 MHz, in zehn Teilbereichen von einer Dekade
Einstellmittel	: Stufenschalter 1 m, 10 m, 0.1 ... 1 M
Einstellung	: stufenlos, mit 3-Drehknopf und Linearskala
Offset	: -5 % ... +5 % relative Variation

Fehlergrenzen

1. Zeitsymmetrische Signalformen	: ±6 % im Bereich 1 m ±5 % im Bereich 10 m ±2 %* im Bereich 0.1 bis 10 k ±3 %* im Bereich 100 k ±4 %* im Bereich 1 M
2. Zeitunsymmetrische Signalformen	: ±8 % im Bereich 1 m ±7 % im Bereich 10 m ±3 %* im Bereich 0.1 bis 10 k ±4 %* im Bereich 100 k
Temperaturkoeffizient	: < 0.3 %/°C bis zu 8 MHz
Langzeitdrift	: < 0.2 % innerhalb von 7 Stunden nach Einlaufdrift von 4 Minuten bei konstanter Temperatur von 25 °C
Frequenzvariation	: 50 ppm, bei Netz-Nennspannung ±10 %

Signalformen

Sinussignal	: 
Rechtecksignal	:  , Tastgrad 0.5
Dreiecksignal	: 
Sägezahn	:  , Tastgrad 0.1 bis 1 MHz  , Tastgrad 0.9 bis 1 MHz
Puls	:  , Tastgrad 0.9 bis 1 MHz  , Tastgrad 0.1 bis 1 MHz

Ausgänge

1. Mit wählbarer Signalform

Wechselspannung	: maximal 40 V Spitze - Spitze (Leerlauf)
DC-Offset	: 0 ... ±10 V
Impedanz	: 50 Ω
Abschwächung	: Stufenlos > 30 dB in Stufen: 0,20 dB
Anstieg/Fallzeit des Rechtecksignals	: < 25 ns bis 10 V _{SS} < 30 ns bis 20 V _{SS}
Maximale Belastung	: dauerkurzschlussfest

* ±0.2 % vom Skalenendwert

2. Rechtecksignal mit fester Amplitude

Ausgangsspannung	: $2 V_{SS}$ (Leerlauf)
Impedanz	: 50Ω
Anstieg/Fallzeit	: $< 18 \text{ ns}$
Maximale Belastung	: dauerkurzschlussfest
Rampen-Linearitätsfehler (im Frequenzbereich 1 mHz ... 100 kHz)	: $< 1 \%$ bis $40 V_{SS}$ $< 0.25 \%$ bis $4 V_{SS}$

Amplitudengang

Bis 10 kHz	: $\pm 1 \%$ für alle Signalformen
Bis 100 kHz	: $\pm 3 \%$ für Sinussignale $\pm 6 \%$ für Dreieck, Sägezahn
Bis 1 MHz	: $\pm 3 \%$ für Sinussignal $\pm 10 \%$ für Dreieck, Sägezahn
Bis 10 MHz	: $\pm 10 \%$ für alle Signalformen

Klirrfaktor des Sinussignals

1 mHz ... 1 Hz	: $< 1 \%$
1 Hz ... 10 kHz	: $< 0.5 \%$
10 kHz ... 100 kHz	: $< 1.0 \%$
100 kHz ... 1 MHz	: $< 2.0 \%$
1 MHz ... 10 MHz	: $< 5.0 \%$

Besondere Funktionen

<i>Frequenzsteuerung</i>	: Über Eingang SWEEP maximal 3 Dekaden mit linearer Abhängigkeit zwischen Steuerspannung und Frequenz 10 V/3 Dekaden
Eingangsimpedanz	: $1 \text{ k}\Omega$
Maximal zulässige Spannung	: $\pm 15 \text{ V}$
<i>Haltefunktion</i>	
Frequenzbereich	: 1 mHz ... 10 Hz
Bedienung	: mit HOLD/RUN Schalter über CONTROL INPUT bei Schalterstellung RUN
Eingangsspannung bei elektronischem HOLD	: $+5 \text{ V}$ an CONTROL INPUT
Eingangswiderstand	: $10 \text{ k}\Omega$
Maximal zulässige Spannung an "CONTROL INPUT"	: $\pm 10 \text{ V}$
<i>SINGLE SHOT Betrieb</i>	
In Frequenzbereich	: 1 mHz ... 1 kHz
Triggerung	: mittels Schalter OFF/SET PHASE/START in Stellung START Über einen negativ gehenden Impuls von 5 V, Fallzeit $< 1 \mu\text{s}$, an CONTROL INPUT
Wahl des Startpunktes	: mittels SET PHASE Steller
Lage des Startpunktes	: an der positiv gehenden Flanke bei Dreieck- und Sägezahnsignalen an der negativ gehenden Flanke des Sinussignals, zwischen negativem und positivem Scheitelwert verschiebbar

CONTROL INPUT Eingangswiderstand	: 10 k Ω
Maximal zulässige Spannung an CONTROL INPUT	: ± 10 V
OVERRRANGE-Anzeige	: Lampe OVERRRANGE leuchtet auf, wenn infolge Vorgabe von DC- und Amplitudensteller der Endverstärker übersteuert werden kann
Kontrollierte Werte	: ± 20 V (Leerlauf) Abschwächer in Stellung 0 dB ± 2 V (Leerlauf) Abschwächer in Stellung -20 dB
Umgebungsbedingungen	
Referenztemperatur	: $+23$ °C
Normalbetriebs-Temperatur	: $+5 \dots 40$ °C
Temperaturbereich für Lagerung und Transport	: $-40 \dots +70$ °C
Speisung	
Spannung	: 110, 128, 202, 220, und 238 V ± 10 %
Frequenz	: 47.5 Hz ... 105 Hz
Leistungsaufnahme	: maximal 52,3 W
Temperaturbereich	: $5 \dots 40$ °C
Abmessungen (gesamt)	: Höhe 145 mm Breite 230 mm Tiefe 285 mm
Gewicht	: 7,5 kg
Betriebslage	: Horizontal, $\pm 30^\circ$
Dieses Gerät entspricht den Schutzklasse I-Bedingungen, gemäss VDE 0411	

1.3. ZUBEHÖR

Normalzubehör

- Gerätehandbuch

Wahlzubehör (gesondert zu bestellen)

- Abschluss, 50 Ω , 3 W, PM 9581
- Koaxialkabel, BNC-BNC PM 9075

2. Gebrauchsanleitung

2.1. ANSCHLUSS UND INBETRIEBNAHME

2.1.1. Sicherheitshinweise (s.a. VDE 0411)

Vor Inbetriebnahme nach Lagerung und Transport des Gerätes ist darauf zu achten, dass das Gerät keine offensichtlichen mechanischen Schäden aufweist.

Besteht der Verdacht, dass die Schutzmassnahmen nicht mehr ausreichend wirksam sind, ist deren Wirksamkeit zu prüfen. Ist der Schutz nicht sichergestellt, so ist das Gerät ausser Betrieb zu nehmen und gegen Wiederinbetriebnahme zu sichern. Vor dem Freilegen spannungsführender Teile ist das Gerät vom Netz zu trennen.

Wartungs- und Überholungsarbeiten, die am unter Spannung stehenden Gerät vorgenommen werden müssen, dürfen nur unter Beachtung der gebotenen Vorsichtsmassnahmen durch eingearbeitete Fachleute ausgeführt werden. Der Netzanschlussstecker der Netzzuleitung darf nur in eine Schutzkontaktsteckdose eingeführt werden. Diese Schutzmassnahme darf nicht unwirksam gemacht werden, z.B. durch eine unvollkommene Verlängerungsleitung.

2.1.2. Anschluss- und Bedienungselemente



Abb. 1 Frontansicht, Bedienungselemente und Anschlüsse



Abb. 2 Rückansicht, Bedienungselemente und Anschlüsse

2.1.3. Aufstellen

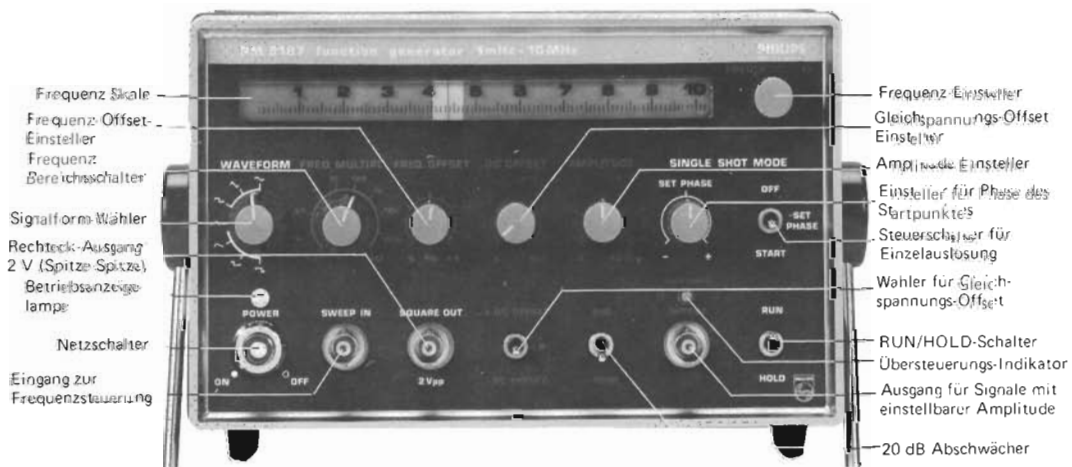
Das Gerät darf entweder in horizontaler Lage oder mit Hilfe des heruntergeklappten Tragbügels in gekippter Lage aufgestellt und betrieben werden.

Die Belüftungsöffnungen an Boden und Deckel dürfen nicht verdeckt werden. Es ist ferner darauf zu achten, dass der Generator nicht auf andere Gegenstände, die Wärme entwickeln, gestellt wird oder übermässiger Wärmeeinstrahlung ausgesetzt wird.

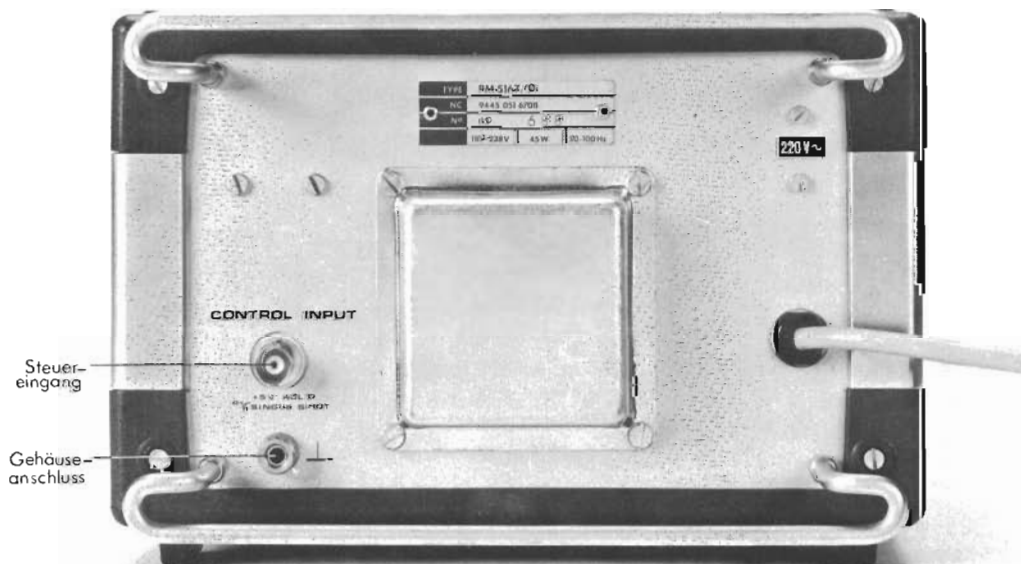
2.1.4. Netzanschluss

Das Gerät darf nur an Wechselspannung betrieben werden. Es ist bei Auslieferung auf einen Netznominalspannungsbereich von $220\text{ V} \pm 10\%$ eingestellt.

Soil das Gerät auf einen anderen Netzspannungsbereich umgestellt werden, wird wie folgt verfahren:

- Netzstecker ziehen
- Bodenabdeckung abnehmen, dazu zwei Schrauben an der Rückwand entfernen
- Primärbeschaltung des Netztrafos umlöten entsprechend nachstehendem Schema
- Bodenabdeckung schliessen und Deckel abnehmen
- Netzspannungsschild an der Gehäuserückwand entsprechend der eingestellten Netzspannung auswechseln
- Gerät schliessen



Abb. 3 Anschluss-Schaltbild für die verschiedenen Netzspannungen.

2.1.5. Erden

Die Schutzerdung des Gerätes muss den örtlichen Vorschriften entsprechend vorgenommen werden.

Die mit dem Gerät fest verbundene Netzzuleitung enthält einen Schutzleiter und ist mit einem Schutzkontakt-Stecker versehen. Dieser Stecker muss mit einer Schutzkontakt-Steckdose verbunden werden. Nur auf diese Weise ist eine wirksame Schutzerdung des Gerätes gewährleistet.

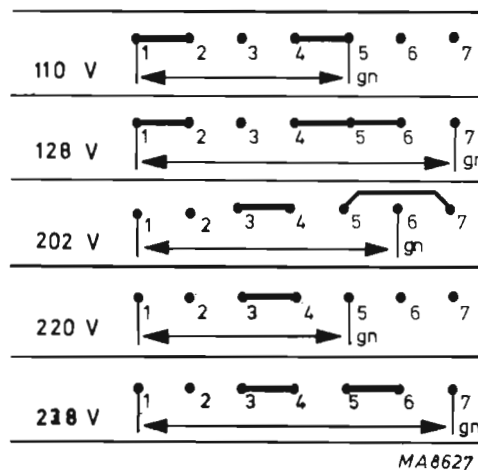
Die an der Rückwand angeordnete Gehäuseanschlussbuchse (⏚) darf nicht als Anschluss für einen Schutzleiter verwendet werden.

Das Schaltungsnullpunkt-Potential des Generators, auf dem die Aussenkontakte aller BNC-Buchsen liegen, ist mit Gehäuse über die Parallelschaltung eines Kondensators und eines Widerstandes verbunden. Damit wird eine eindeutige HF-Erdung der Schaltung bewirkt.

2.2. BEDIENUNG







Anmerkung:

Falls das Gerät **NICHT** in SINGLE SHOT oder HOLD mode betrieben wird, ist darauf zu achten dass in den Frequenzbereichen 1 m ... 100 für SINGLE SHOT Betrieb und 1 m ... 1 für HOLD Betrieb die Schalter OFF/SET PHASE/START und RUN/HOLD sich in Stellungen OFF bzw. RUN befinden, da anderenfalls kein Signal an Buchse OUTPUT erscheint.

2.2.1. Einschalten des Gerätes

Nachdem die Verbindung des Generators mit dem Netz entsprechend Punkt 2.1.4. hergestellt ist, wird das Gerät durch Eindrücken des Netzschalters POWER eingeschaltet. Das Aufleuchten der oberhalb des Netzschalters angeordneten Lampe zeigt an, dass das Gerät betriebsbereit ist. Das weisse Feld im Knopf des Netzschalters signalisiert mechanisch die Stellung des Netzschalters.

2.2.2. Wählen der Signalform

Mit dem Signalform-Wähler WAVEFORM wird die gewünschte Signalform eingestellt. Die Skale des Schalters ist in zwei Bereiche geteilt. Der eine Bereich umfasst zeitsymmetrische Signale (, , ) während der andere Bereich zeitunsymmetrische Signale (, , , ) enthält.

Das Signal mit der so gewählten Form steht an der BNC-Buchse OUTPUT zur Verfügung.

Bitte beachten: Für zeitunsymmetrische Signale ist die obere Frequenzgrenze 1 MHz in Stellung 100 k des Frequenzbereichsschalters FREQ. MULTIPL.

2.2.3. Einstellen der Frequenz

Zur Einstellung der Frequenz stehen drei Einstellmittel zur Verfügung:

1. Frequenz-Einsteller FREQUENCY Hz mit Linearskala
2. Frequenz-Bereichsschalter FREQ. MULTIPL.
3. Frequenz-Offset-Einsteller FREQ. OFFSET

Mit dem Frequenz-Einsteller und dem Frequenz-Bereichsschalter wird die gewünschte Sollfrequenz eingestellt, der Frequenz-Offset-Einsteller muss dabei in der Mittelstellung stehen. Die Ausgangsfrequenz ist gleich dem Produkt aus dem Zahlenwert auf der Linearskala und dem Zahlenwert am Frequenz-Bereichsschalter (Beispiel: Skala 1.9 x Bereichsschalter 10 k = Ausgangsfrequenz 19 kHz).

Mit dem Frequenz-Offset-Einsteller kann eine Verstimmung der Frequenz um $\pm 5\%$ des eingestellten Wertes vorgenommen werden.

2.2.4. Einstellen der Signalamplitude und des DC-Offset

Die Signalamplitude an der BNC-Buchse OUTPUT ist mit dem Einsteller AMPLITUDE stetig und mit dem Abschwächer 0 dB/–20 dB in 2 Stufen einstellbar.

Steht der Abschwächer auf 0 dB, so überstreicht der Amplituden-Einsteller einen Bereich bis 40 V (Spitze-Spitze); steht der Abschwächer auf –20 dB, so ist eine Ausgangsspannung bis zu 4 V (Spitze-Spitze) einstellbar.

Mit dem Schalter +DC OFFSET/0/–DC OFFSET und dem Einsteller DC OFFSET kann dem Ausgangssignal eine Gleichspannung hinzugefügt werden. In der Stellung 0 des Schalters ist der Gleichspannungs-Offset abgeschaltet, mit den beiden anderen Stellungen wird die Polarität gewählt. Die Spannung des Offset ist mit dem Offset-Einsteller zwischen 0 und 10 V stetig einstellbar.

Der Übersteuerungs-Indikator OVERRANGE leuchtet auf, wenn der Endverstärker infolge gleichzeitiger Vorgabe zu hoher Signalamplitude und zu hohen DC-Offsets übersteuert werden könnte. Der Indikator leuchtet also schon bei zu hoher Einstellung dieser Werte, ohne dass schon eine Übersteuerung (z.B. vor der Auslösung einer Einzelperiode) erfolgt ist. Die überwachten Grenzwerte der Summe einer Signal- und Offset-Spannung sind ± 20 V (Abschwächer auf 0 dB) bzw. ± 2 V (Abschwächer auf –20 dB).

2.2.5. Rechteck-Ausgang

Am Ausgang SQUARE OUT gibt der Generator ein nullsymmetrisches Rechtecksignal von 2 V (Spitze-Spitze) ab. Die Frequenz ist gleich der eingestellten Frequenz. Der Tastgrad ist abhängig von der eingestellten Signalform. Bei zeitsymmetrischen Signalen beträgt er 0,5, bei zeitunsymmetrischen Signalen 0,1 bzw. 0,9.

2.2.6. Frequenzsteuerung

Durch Einspeisen eines Signals in den Eingang SWEEP IN kann die Frequenz des Generators gesteuert werden. Die Frequenz ändert sich dabei linear mit der Steuerspannung nach der Funktion

$$f_0 = m \left(n_s + \frac{U_C}{V} \right) \text{ Hz, wenn } 0 < \left(n_s + \frac{U_C}{V} \right) < 10$$

Darin ist f_0 = Signalfrequenz am Generatorausgang

m = am Frequenz-Bereichsschalter eingestellter Faktor (10^{-3} , 10^{-2} ... 10^6)

n_s = an der Linearskala eingestellter Zahlenwert (0.01 ... 10)

U_C = Steuerspannung am Eingang SWEEP IN

Maximal kann über drei Frequenzdekaden gesteuert werden (siehe Abb. 4). Um bei der unteren Hubgrenze ein jitterfreies Signal zu erhalten – Frequenz- und Phasenjitter tritt auf infolge kleinster Störspannungen auf dem Steuersignal – ist es bei Frequenzsteuerung über mehr als eine Frequenzdekade empfehlenswert, auf der Skala die jeweils gewünschte untere Grenzfrequenz einzustellen und durch Zuführung einer positiven Spannung höhere Frequenzen auszusteuern.

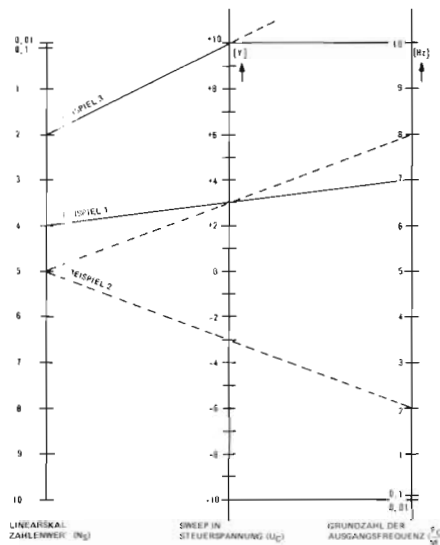

- | | | |
|-------------|---------------------------------|--------------------------|
| Beispiel 1: | Skala eingestellt auf | 4 |
| | Steuerspannung an SWEEP IN | + 3 V |
| | Ausgangsfrequenz | (7 x Bereich m) Hz |
| Beispiel 2: | Skala eingestellt auf | 5 |
| | Steuerspannung an SWEEP IN | 6 V Spitze - Spitze |
| | Hubbereich der Ausgangsfrequenz | (2 ... 6 x Bereich m) Hz |
| Beispiel 3: | Skala eingestellt auf | 2 |
| | Steuerspannung an SWEEP IN | + 10 V |
| | Ausgangsfrequenz | nicht definiert |

NA-9217

Abb. 4 Sweepbereich PM 5167.

2.2.7. Einzelauslösung SINGLE SHOT MODE

Der Generator verfügt über eine Einrichtung, mit der einzelne Perioden eines Signals mit eingestellter Frequenz und Signalform abgegeben werden können.

Die Einzelauslösung ist bei allen Signalformen und in den Frequenz-Teilbereichen 1 m ... 1k wirksam. Der Startpunkt kann mit dem Einsteller SET PHASE stetig zwischen den Scheitelwerten des Signals (gemäss Fig. 5) verstellt werden.

Im einzelnen wird wie folgt verfahren:

- Signalform wählen (2.2.2)
- Frequenz einstellen (2.2.3)
- Signalamplitude und DC-Offset einstellen (2.2.4)
- Steuerschalter für Einzelauslösung auf SET PHASE stellen
- Einsteller SET PHASE entsprechend Fig. 5 auf den gewünschten Startpunkt stellen.
- Einzelperiode durch Niederdrücken des Steuerschalters in die Stellung START auslösen.

Die Auslösung kann auch durch einen negativ gehenden Spannungssprung von 0 auf -5 V und einer Fallzeit von $< 1\ \mu\text{s}$ am CONTROL INPUT (Rückwand) erfolgen.



Abb. 5. Startpunkte der verschiedenen Signale im "SINGLE SHOT" Betrieb

2.2.8. Haltefunktion

Der zeitliche Ablauf des Ausgangssignals kann in den Stellungen 1 m ... 1 des Frequenzbereichsschalters FREQ. MULTIPL. angehalten werden. Hierzu wird entweder der Steuerschalter RUN/HOLD in die HOLD-Position gestellt oder es wird eine Gleichspannung von $+5\text{ V}$ an den CONTROL INPUT (Rückwand) gelegt.

Notice d'emploi

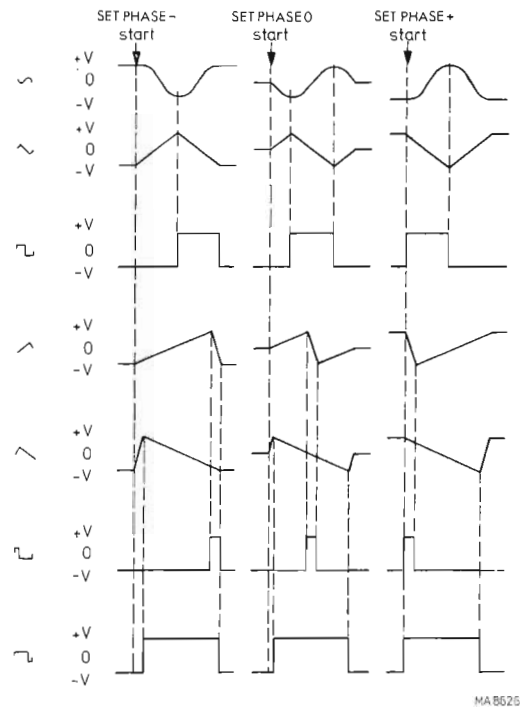
1. Généralités

1.1. INTRODUCTION

Le générateur de fonctions PM 5167 offre une large gamme de fréquence (1 mHz - 10 MHz) et une tension de sortie élevée ($40 V_{CC}$ en circuit ouvert).

Il fournit de plus une grande variété de signaux: sinusoïdaux/triangulaires/rectangulaires, dents de scie et impulsions.

D'excellentes caractéristiques, des possibilités intéressantes, telles que, entrée wobble, déclenchement monocoup avec départ réglable en phase, position maintenue, tension DC d'offset et une présentation compacte font du PM 5167 un outil universel pour le laboratoire d'électronique, le développement et la fabrication.

Les autres caractéristiques sont:

- indication de surcharge
- Commande d'offset de fréquence
- Entrée de commande (à l'arrière)
- Atténuateur 20 dB

Deux sorties sont disponibles:

- une sortie fournissant l'un quelconque des signaux sélectionnés avec une amplitude réglable, un niveau DC, un offset de fréquence
- une sortie fournissant un signal rectangulaire avec une amplitude fixe symétrique par rapport au 0 et réglable en fréquence

1.2. CARACTÉRISTIQUES TECHNIQUES







Instructions générales

- Les tensions alternatives sont spécifiées en valeurs efficaces
- Seules les valeurs avec tolérances ou limite d'erreurs sont des données garanties.
- Les erreurs relatives (en % ou ppm) se réfèrent à une valeur ajustée.
- Toutes les spécifications sont données après une période de préfonctionnement de 30 minutes.

Fréquence

Plage	: 1 mHz ... 10 MHz en 10 gammes de 1 décade
Réglage de gamme	: au moyen du sélecteur 1 m, 10 m, 0.1 ... 1 M
Réglage fin	: continu, bouton 3 tours et échelle linéaire
Variation relative	: -5 % ... +5 %
Précision	
1. Signaux symétriques	: ±6 % dans la gamme 1 m ±5 % dans la gamme 10 m ±2 %* dans la gamme 0.1 to 10 k ±3 %* dans la gamme 100 k ±4 %* dans la gamme 1 M
2. Signaux asymétriques	: ±8 % dans la gamme 1 m ±7 % dans la gamme 10 m ±3 %* dans la gamme 0.1 to 10 k ±4 %* dans la gamme 100 k
Coefficient de température	: < 0.3 %/°C jusqu'à 8 MHz
Dérive à long terme	: < 0.2 % en 7 heures après 4 minutes de fonctionnement à température constante de 25 °C
Variation de fréquence	: < 50 ppm à la tension secteur nominale ±10 %

Signaux

Signal sinusoïdal	: 
Signal carré	:  , rapport cyclique 0.5
Signal triangulaire	: 
Dents de scie	:  , rapport cyclique 0.1 jusqu'à 1 MHz  , rapport cyclique 0.9 jusqu'à 1 MHz
Impulsions	:  , rapport cyclique 0.9 jusqu'à 1 MHz  , rapport cyclique 0.1 jusqu'à 1 MHz

Sorties

1. Signal commutable	
Tension AC	: 40 V _{CC} max. (circuit ouvert)
Offset DC	: 0 ... ±10 V
Impédance	: 50 Ω (protégé contre les courts-circuits)
Atténuation	: continu > 30 dB 1 échelon, 20 dB
Temps montée/descente du signal carré	: < 25 ns jusqu'à 10 V _{CC} < 30 ns jusqu'à 20 V _{CC}
Charge maximale	: exempt de courts-circuits en permanence

* ±0.2 % de la valeur max. de la gamme

2. Signal carré avec amplitude fixe

Tension de sortie	: $2 V_{CC}$ (circuit ouvert)
Impédance	: 50Ω
Temps de montée et de descente	: $< 18 \text{ ns}$
Charge maximale	: exempt de courts-circuits en permanence
Erreur de linéarité de la rampe (dans la gamme 1 mHz ... 100 kHz)	: $< 1 \%$ jusqu'à $40 V_{CC}$ $< 0.25 \%$ jusqu'à $4 V_{CC}$

Réponse en fréquence

jusqu'à 10 kHz	: $\pm 1 \%$ pour tous les signaux
jusqu'à 100 kHz	: $\pm 3 \%$ en sinusoïdal $\pm 6 \%$ en triangulaire et dents de scie
jusqu'à 1 MHz	: $\pm 3 \%$ en sinusoïdal $\pm 10 \%$ en triangulaire et dents de scie
jusqu'à 10 MHz	: $\pm 10 \%$ pour tous les signaux

Distorsion en sinusoïdal

1 mHz ... 1 Hz	: $< 1 \%$
1 Hz ... 10 kHz	: $< 0.5 \%$
10 kHz ... 100 kHz	: $< 1.0 \%$
100 kHz ... 1 MHz	: $< 2.0 \%$
1 MHz ... 10 MHz	: $< 5.0 \%$

Fonctions spéciales

Commande de fréquence : Via l'entrée SWEEP, 3 décades max. relation linéaire entre tension et fréquence 10 V/3 décades

Impédance d'entrée	: $1 \text{ k}\Omega$
Tension max. admissible	: $\pm 15 \text{ V}$

Fonction maintenue HOLD

Gamme	: 1 mHz ... 10 Hz
Opération	: via le commutateur Hold/Run via CONTROL INPUT en position RUN
Tension d'entrée pour la fonction HOLD	: +5 V, sur CONTROL INPUT
Résistance d'entrée	: $10 \text{ k}\Omega$
Tension max. admissible sur CONTROL INPUT	: $\pm 10 \text{ V}$

Mode monocoup SINGLE SHOT

Gamme	: 1 mHz ... 1 kHz
Déclenchement	: au moyen du commutateur OFF/SET PHASE/START en position START par une impulsion négative de 5 V, temps de descente < 1 μ s sur CONTROL INPUT
Sélection du point de départ	: au moyen de la commande SET PHASE
Position du point de départ	: sur la rampe positive pour les signaux triangulaires et dents de scie sur la pente négative en sinusoïdal, réglable entre les valeurs crêtes positive et négative
Résistance d'entrée de CONTROL INPUT	: 10 k Ω
Tension max. admissible sur CONTROL INPUT	: ± 10 V

Indication de surcharge	: le témoin OVERRANGE indique que les niveaux AC+DC saturent l'amplificateur de sortie
Valeurs contrôlées	: ± 20 V (circuit ouvert) atténuateur en position 0 dB ± 2 V (circuit ouvert) atténuateur en position -20 dB

Alimentation

Tension	: 110, 128, 202, 220 and 238 V ± 10 %
Fréquence	: 47.5 Hz ... 105 Hz
Consommation	: 52,3 W max.
Gamme de température	: 5 ... 40 °C

Conditions d'environnement

Température de référence	: +23 °C
Température de fonctionnement normal	: +5 ... +40 °C
Température pour transport et stockage	: -40 ... +70 °C
Position de travail	: horizontale, $\pm 30^\circ$

Dimensions	hauteur	145 mm
	largeur	230 mm
	profondeur	285 mm

Poids	: 7.5 kgs
-------	-----------

Cet appareil est conforme à la norme VDE 0411 classe I, protection standard.

1.3. ACCESSOIRES

Fourni avec l'appareil

– Mode d'emploi

Fournis en option

– Charge, 50 Ω , 3 W PM 9581

– Cordon coaxial, BNC-BNC PM 9075

2. Mode d'emploi

2.1. INSTALLATION

2.1.1. Règles de sécurité (normes IEC 348 et VDE 0411)

Avant d'utiliser l'appareil après stockage et transport, vérifier s'il présente des dommages matériels.

Au cas où un doute subsisterait quant à l'efficacité de la protection, contrôler ce point.

Si la protection n'est pas assurée, l'appareil doit être débranché du secteur.

L'appareil doit toujours être débranché avant de l'ouvrir.

Les travaux d'entretien et de maintenance à effectuer sur un appareil alimenté ne peuvent être réalisés que par un technicien qualifié.

La fiche secteur ne peut être mise que dans une prise secteur avec contact de terre.

Cette sécurité ne peut pas être supprimée, même avec un câble de prolongement inadéquat par exemple.

2.1.2. Bornes et réglages (fig. 1 et 2)



Fig. 1. Vue de face.

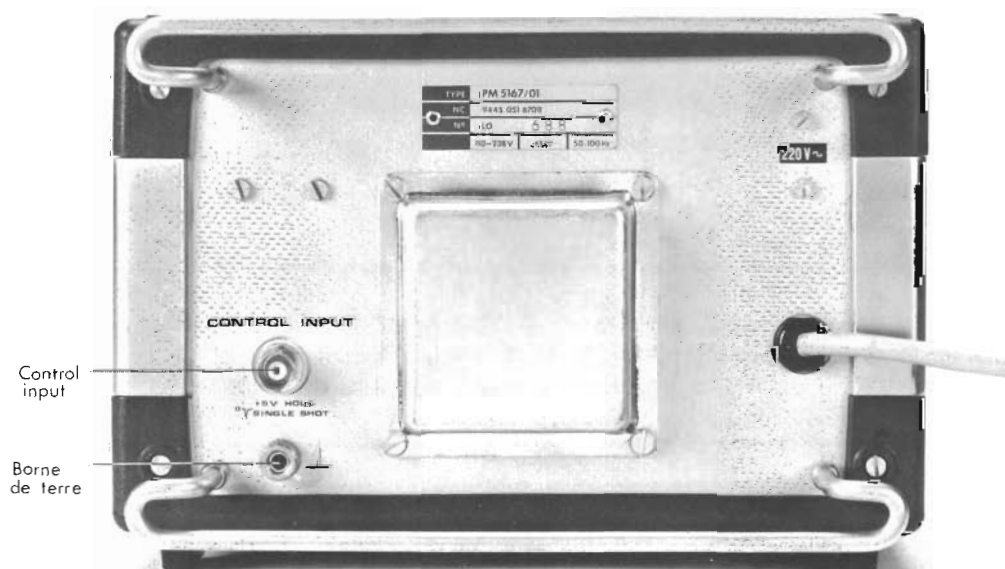

Fig. 2. Vue arrière

2.1.3. Position

L'appareil doit être placé horizontalement ou incliné après avoir pivoté l'étrier-support. Les ouvertures de ventilation dans les plaques supérieure et inférieure ne peuvent pas être recouvertes. Veiller à ne pas mettre l'appareil sur des objets produisant de la chaleur.

2.1.4. Branchement au secteur

L'appareil ne peut être alimenté qu'en alternatif.

A la livraison, il est réglé sur 220 V \pm 10 %.

En cas d'utilisation sur une autre tension, procéder comme suit:

- Débrancher la fiche secteur
- Enlever la plaque de base après avoir dévissé les deux vis à l'arrière
- Modifier le circuit du primaire en fonction du schéma (fig. 3)
- Remettre la plaque de base et enlever le couvercle
- Changer la plaquette de tension secteur à l'arrière conformément à la tension réglée
- Fermer l'appareil

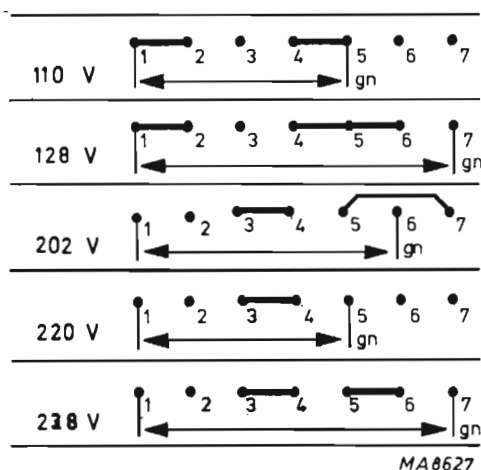

Fig. 3. Schéma de branchement pour différentes tensions d'alimentation

2.1.5. Mise à la terre

La protection terre du générateur doit répondre aux règles de sécurité locales. Le cordon secteur livré présente un conducteur de protection relié au contact terre de la fiche. Cette fiche ne peut donc être branchée que sur une prise secteur à contact de terre. La protection terre de l'appareil n'est garantie que de cette façon.

La prise (\perp) à l'arrière ne doit pas être utilisée pour brancher un conducteur de protection.

Le potentiel zéro du générateur (contacts externes des connecteurs BNC) est relié au boîtier par l'intermédiaire d'un circuit parallèle RC.

Une mise à la terre HF correcte est ainsi obtenue.

2.2. MODE D'EMPLOI

Remarque:

Au cas où l'appareil n'est pas utilisé en modes SINGLE SHOT ou HOLD, veiller à ce que, dans les gammes de fréquence 1 m ... 100 en mode SINGLE SHOT et 1 m ... 1 en mode HOLD, les commutateurs OFF/SET PHASE/START et RUN/HOLD sont respectivement en positions OFF et RUN.







Dans le cas contraire, il n'y a pas de signal sur la douille OUTPUT.

2.2.1. Mise en service

Brancher le générateur selon 2.1.4. et mettre l'appareil en service en enfonçant le bouton POWER.

La lampe-témoin correspondante s'allume, indiquant que l'appareil est prêt à l'usage. La partie blanche du bouton POWER indique également que l'appareil est en service.

2.2.2. Sélection de la forme d'onde

La forme d'onde est sélectionnée à l'aide du commutateur WAVEFORM. L'échelle de ce commutateur est divisée en deux gammes, une pour les signaux symétriques ( ,  , ), l'autre pour les signaux asymétriques ( ,  ,  , ).

Le signal sélectionné est disponible sur la borne BNC OUTPUT.

Attention: Pour des signaux asymétriques, la limite 1 MHz est obtenue en position 100 k du commutateur FREQ. MULTIPL.

2.2.3. Réglage de fréquence

La fréquence peut être réglée de trois façons:

1. par la commande FREQUENCY Hz avec l'échelle linéaire
2. par le commutateur de gamme FREQ. MULTIPL.
3. par la commande de variation de fréquence FREQ. OFFSET

Dans les deux premiers cas, la fréquence nominale requise est réglée, la commande de variation de fréquence étant réglée en position médiane.

La fréquence de sortie est égale au produit de la valeur sur l'échelle linéaire et de la valeur du commutateur de gamme (exemple: échelle 1.9 x commutateur de gamme 10 k = fréquence de sortie 19 kHz).

Une variation de fréquence peut être obtenue à l'aide de la commande de variation de fréquence, à savoir $\pm 5\%$ de la valeur nominale.

2.2.4. Réglage d'amplitude et d'offset continu

L'amplitude sur la borne BNC OUTPUT peut être réglée avec la commande AMPLITUDE et en deux échelons avec l'atténuateur 0 dB/−20 dB.

Si l'atténuateur est sur 0 dB, la commande AMPLITUDE couvre une gamme jusqu'à $4 V_{CC}$. Si l'atténuateur est sur −20 dB, la tension de sortie est réglable jusqu'à $4 V_{CC}$. Une tension continue peut être ajoutée au signal de sortie à l'aide du commutateur +DC OFFSET/0/−DC OFFSET et du potentiomètre DC OFFSET. En position 0 l'offset est supprimé, tandis que la polarité est réglée sur les deux autres positions.

La tension d'offset est réglable de façon continue entre 0 et 10 V.

L'indicateur OVERRANGE s'allume lorsque l'amplitude du signal AC et de l'offset continue saturent l'amplificateur de sortie. Dans ce cas, l'indicateur OVERRANGE s'allume même s'il n'y a pas de signal à la borne OUTPUT, par ex. avant une période monocoup.

La somme du signal et de l'offset continu sélectionnés (indicateur OVERRANGE allumé) est limité à ± 20 V avec l'atténuateur par échelons sur 0 dB et à ± 2 V avec atténuateur sur −20 dB.

2.2.5. Sortie rectangulaire

Le générateur fournit un signal rectangulaire de $2 V_{CC}$ symétrique sur la sortie SQUARE OUT. La fréquence est égale à la fréquence réglée. Le facteur de forme dépend du signal réglé. Pour des signaux symétriques, le facteur de forme est 0,5, pour les signaux asymétriques il est 0,1 ou 0,9.

2.2.6. Commande de fréquence

La fréquence du générateur peut être réglée en appliquant un signal à l'entrée SWEEP IN. La fréquence varie linéairement avec la tension de commande selon la fonction:

$$f_0 = m \left(n_s + \frac{U_c}{V} \right) \text{ Hz, lorsque } 0 < \left(n_s + \frac{U_c}{V} \right) < 10$$

f_0 = fréquence du signal de sortie

m = facteur réglé avec le commutateur de gamme (10^{-3} , 10^{-2} ... 10^6)

n_s = valeur réglée sur l'échelle linéaire (0,01 ... 10)

U_c = tension de commande à l'entrée SWEEP IN

Trois décades de fréquence au maximum peuvent être commandées par balayage externe (voir fig. 4). Afin d'éviter le jitter de fréquence et de phase, lequel peut résulter de petits signaux d'interférence sur le signal de commande, il est recommandé, en cas de balayage supérieur à une décade, de régler le générateur (voir 2.2.3.) sur la plus basse fréquence requise et de couvrir la gamme totale par un signal de polarité positive.

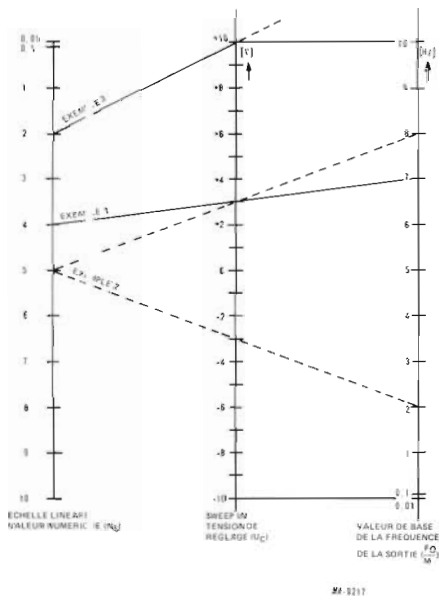

- | | | |
|------------|-----------------------------|-------------------------|
| Exemple 1: | Echelle réglée sur | 4 |
| | Tension réglée sur SWEEP IN | + 3 V |
| | Fréquence résultante | (7 x gamme m) Hz |
| Exemple 2: | Echelle réglée sur | 5 |
| | Tension réglée sur SWEEP IN | ~ 6 V cc |
| | Fréquence résultante | (2 ... 6 x gamme m) Hz |
| Exemple 3: | Echelle réglée sur | 2 |
| | Tension réglée sur SWEEP IN | + 10 V |
| | Fréquence résultante | indéfinie. |

Fig. 4. Gamme de balayage

2.2.7. Mode monocoup

Le générateur possède une unité permettant de produire des périodes simples avec fréquence et forme de signal sélectionnés.

Le mode monocoup est possible pour tous les signaux et dans les gammes de 1 m à 100. Le point de départ peut être ajusté de façon continue entre les valeurs crêtes du signal (figure 5) à l'aide du potentiomètre SET PHASE.

A cet effet, procéder comme suit:

- Sélectionner la forme de signal (2.2.2.)
- Régler la fréquence (2.2.3.)
- Régler l'amplitude et l'offset continu (2.2.4.)
- Régler le commutateur de commande sur SET PHASE.
- Régler le potentiomètre SET PHASE sur le point de départ requis (figure 5).
- Une période simple est obtenue en enfonçant le commutateur OFF/SET PHASE/START en position START.

Une période peut également être obtenue en appliquant une impulsion négative de 5 V avec temps de descente $< 1 \mu\text{s}$ sur CONTROL INPUT (à l'arrière de l'appareil).

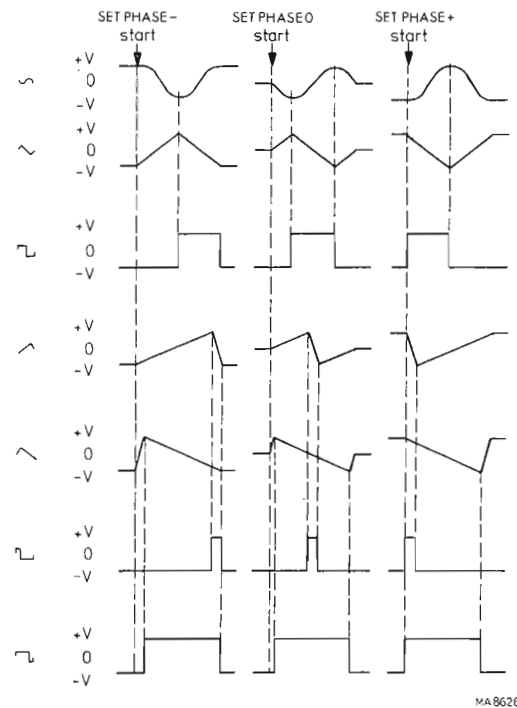

Fig. 5. Points de départ pour les signaux en mode "SINGLE SHOT"

2.2.8. Fonction maintenue

Le signal de sortie est maintenue à sa tension instantanée soit en mettant le commutateur RUN/HOLD sur HOLD, soit en appliquant une tension continue de +5 V sur CONTROL INPUT (panneau arrière). La fonction HOLD n'est efficace que pour les positions 1 m ... 1 de sélecteur de fréquence.

3. Service manual

3.1. DESCRIPTION OF THE BLOCKDIAGRAM (Fig. 6)

The oscillator is formed by the CONSTANT CURRENT SOURCE, the CURRENT INTEGRATOR and the COMPARATOR. It produces and determines depending of the position of the frequency control (FREQUENCY Hz), the frequency range selector (FREQ. MULTIPL.) and the frequency offset control (FREQ. OFFSET), the frequency of the output signal.

Switching over from time-symmetrical (duty cycle 0.5) to time-asymmetrical (duty cycle 0.1 or 0.9) signals is achieved by means of the waveform selector (WAVEFORM), acting upon the constant current source.

Sweeping with an external voltage is attained by applying this voltage to the constant current source via BNC-socket SWEEP IN. The external voltage also controls the productiveness of the constant current source.

The oscillator also produces a square-wave signal with fixed amplitude which is available at output socket SQUARE OUT.

A triangular and square-wave signal from the oscillator is supplied to the waveform selector (WAVEFORM). Depending of the position of the latter switch the duty cycle is 0.1, 0.5 or 0.9.

In the position ~ of the WAVEFORM switch the time-symmetrical triangular waveform is applied to the SINE SHAPER. The sinewave formed by the sine shaper is supplied to the ATTENUATOR via the waveform selector.

With control AMPLITUDE a continuous attenuation of the signal is obtained. By the OUTPUT AMPLIFIER the signal is amplified to the required value. In the output amplifier the signal can be set to a selectable DC-level between 0 and 10 V with the aid of switch + DC OFFSET/0/- DC OFFSET and control DC OFFSET. The overrange indicator OVERRANGE signalizes, controlled by the controls AMPLITUDE and DC OFFSET, that the limit of the workable control range of the output amplifier is overstepped.

With switch 0 dB/-20 dB the output signal can be attenuated by 20 dB.

The output signal of the generator is available at BNC-socket OUTPUT.

Switch RUN/HOLD blocks the oscillator when placed in position HOLD.

Then the output voltage stops on its last instantaneous value. The latter function can also be realized by an external d.c.-voltage, applied to socket CONTROL INPUT at the rear of the instrument.

In the SINGLE SHOT MODE the oscillator is blocked and triggered respectively using single triggered pulses.

To operate this mode, control switch OFF/SET PHASE/START and to adjust the starting point control SET PHASE have to be used.

The generator produces a SINGLE SHOT when pushing the control switch to position START or by applying a negative pulse to the CONTROL INPUT.

The HOLD-function can also be used in the mode SINGLE SHOT.

The power supply provides the circuits, the for a good working required stabilized d.c.-voltages.

3.1.1. Description of the circuit diagram

The function generator contains the following units (see figs. 15 and 22)

- . Wave-form switch unit U1
- . Frequency - switch unit U2
- . Oscillator unit U3
- . Sine-shaper unit U4
- . Control unit U5
- . Power amplifier unit U6
- . d.c.-supply unit U7

3.1.2. Oscillator unit U3

The oscillator, see figs. 7 and 22, mainly consists of:

- a four-transistor switching array 1 to generate the triangular voltage
- a four-transistor switching array 2 to generate the square-wave voltage
- a comparator
- three impedance transformers for output decoupling and
- an amplitude control circuit to stabilize the triangular voltage at high frequencies.

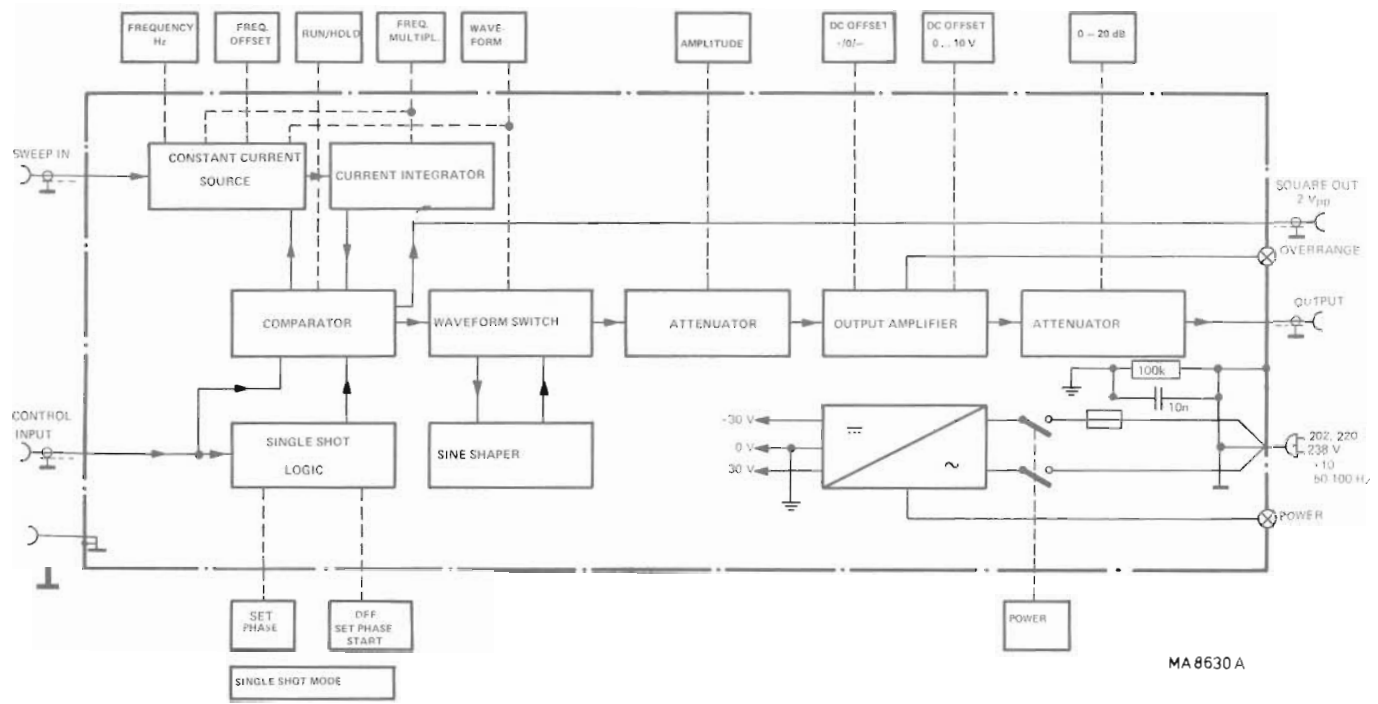

Fig. 6. Block diagram of the generator

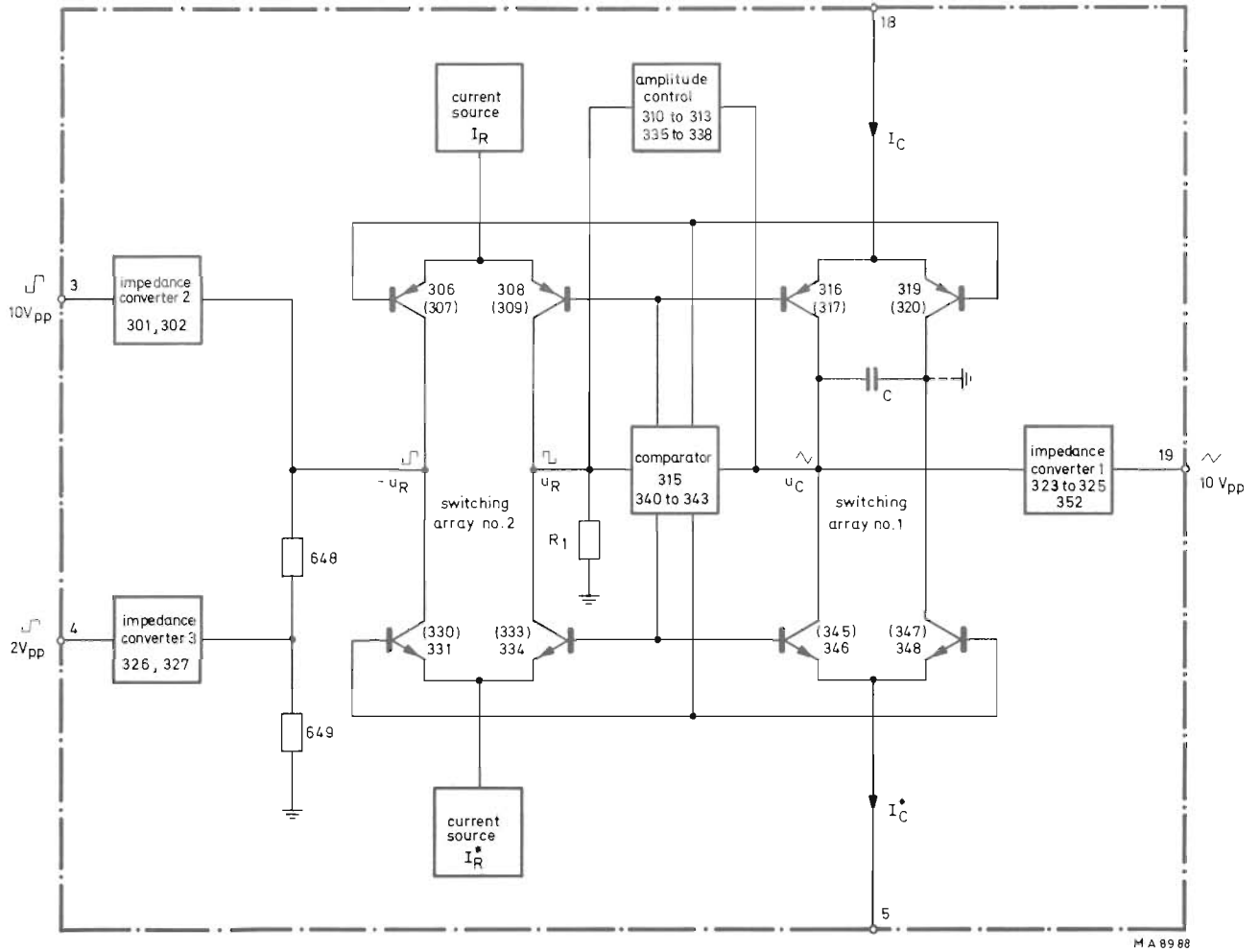

Fig. 7. Block diagram of the oscillator U3

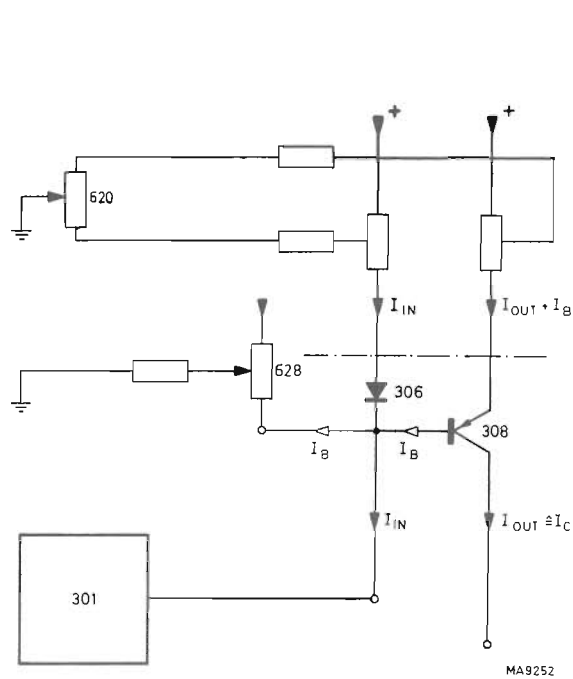

Fig. 8. Principle of the current mirror

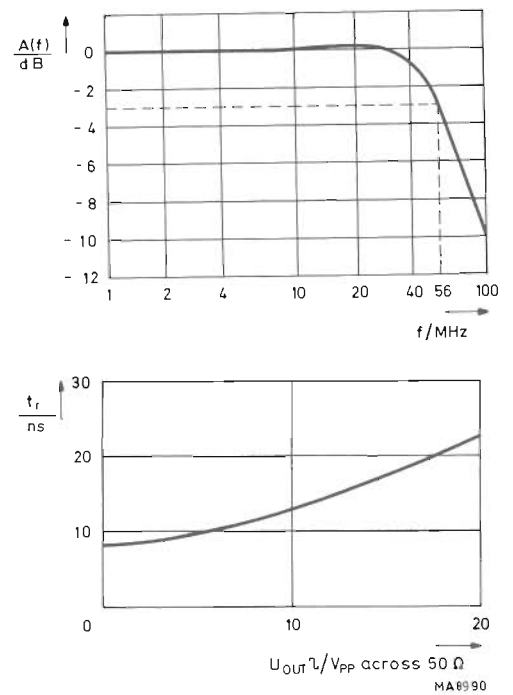

Fig. 9. Graph of amplitude response and rise time

- 3.1.2.1. Via common-base stages 318, 349 the driving currents I_C and I_C^* are applied to switching array 1, U3/316, 319, 346 and 348.

At capacitor C (U2/501 to 510 and 512) a time-linear, positive- or negative-going voltage appears, the value of which depends on the position of the switching array:

$$u_C(t) = \frac{I}{C} \cdot t \quad , \quad u_C(t) = -\frac{I^*}{C} \cdot t \quad \text{respectively}$$

A better distribution of dissipation is obtained via common-base stages U3/317, 320, 345 and 347.

- 3.1.2.2. Currents I_R and I_R^* from two current sources U3/305 and 332 are applied to switching array 2, U3/306, 308, 331 and 334.

The above-mentioned current sources are adjusted by means of U3/615 and U3/657 in such a way that offset and amplitude of the square-wave voltage correspond to the values required. A square-wave voltage u_R appears at resistor R1 (U3/659-660) by reversing periodically the switching array.

An inverse square-wave $-u_R$ appears simultaneously at resistor U3/648-649.

The common-base stages U3/307, 309, 330 and 333 reduce the square-wave rise time.

- 3.1.2.3. The comparator (U3/315, 340 to 343) compares the voltages u_C and u_R .

The comparator switches over as soon as u_C reaches u_R . As this is a periodical process, a square-wave voltage appears at R1 and a triangular voltage of equal amplitude at C.

The rise times t_r and t_f of the triangular voltage are:

$$t_r = \frac{2 \cdot C}{I_C} \left| u_R \right| \quad \quad t_f = \frac{2 \cdot C}{I_C^*} \left| u_R \right|$$

The frequency of the triangular voltage is

$$f = \frac{1}{t_r + t_f}$$

At a time-symmetrical triangular voltage, $t_r = t_f$; $I_C = I_C^*$ and $f = \frac{I_C}{4C} \cdot \frac{1}{|u_R|}$

At a time-asymmetrical triangular voltage (sawtooth) the oscillator will be fed by two different driving currents.

As the oscillation frequency must be identical for asymmetrical as well as symmetrical operation, the driving currents I_C and I_C^* must behave as follows:

Duty cycle	I_C	I_C^*
0,1	5 · I	$\frac{5 \cdot I}{9}$
0,5	I	I
0,9	$\frac{5 \cdot I}{9}$	5 · I

- 3.1.2.4. Impedance converter 1 is controlled by u_C . Decoupling is performed at very high impedance by a FET-pair U3/324, which is operated as source follower and as power source. The power source serves linearizing offset and temperature compensation. The complementary emitter-follower (U3/325 and 352) reduces the output impedance to 50 Ω .

- 3.1.2.5. Impedance converter 2 consists of a complementary emitter-follower U3/301 and 302, which decouples the square-wave voltage $-u_R$ at resistors U3/648 and 649 and causes an output impedance of 50 Ω .

Service manual

- 3.1.2.6. Impedance converter 3 consists of a complementary emitter follower U3/326 and 327 which decouples the square-wave voltage at U3/649 attenuated to $2 V_{pp}$ and causes an output impedance of 50Ω .
- 3.1.2.7. The amplitude control operates at frequencies higher than 3 kHz and compensates the rise of the triangular-voltage amplitude at R_1 for. The rise of the triangular-voltage amplitude is due to the short switching intervals of comparator 1 (ca. 20 ns), during which the triangular voltage keeps its momentary rise direction. At 10 MHz the triangular voltage reaches a rise speed of $10 V/50 ns$, which would cause an amplitude increase of $10 V \cdot 20 ns/50 ns = 4 V$.
The amplitude control reduces the amplitude of the square-wave voltage at R_1 by 4 V at 10 MHz, which results in a linear amplitude response of the triangular voltage. The FET-pair U3/323 performs the high-ohmic decoupling of the triangular voltage.
One of the two transistors is used for offset- and temperature compensation, the adjustment of which is achieved by U3/681||682. The high-pass filter U3/637, 690, 514 suppresses the control effect below 3 kHz.
In the controller used as integrator (U3/311 to 313 and 336 to 338), the actual value of the triangular voltage obtained by peak rectifying (diodes U3/403, 410) is compared with the nominal values at the base contacts of transistors U3/313 and 338. The controller reduces the square-wave amplitude at R_1 by means of the transistors (U3/309, 310 and 333, 335) used as adjusting elements. The adjustment of the nominal value is carried out by select-on-test resistors U3/619, 663.
- 3.1.2.8. The hold-condition is obtained by means of transistors U3/321, 350, 322, 351.
When U3/16 is connected to U3/17 via switch run/hold (807), all transistors mentioned are conductive. No current passes then through the switching array. The connected capacitor C (U2/501 to 510 and 512) remains charged, voltage remains available at connection point 13 and switching array 1 stops oscillating. Transistors U3/304, 329 and 303, 328 enables the single-shot operation to be performed. If $-5 V$ is applied to connection point U3/20 all transistors mentioned are conductive.
The switching array 2 no longer oscillates. U3/304 is connected in parallel with U3/306 so that I_R is applied to U3/648 and 649, independent of the position of the switching array. In the same way U3/329 is connected in parallel with U3/334. As a result of this u_R becomes $-5 V$.
The triangular oscillation is held until the triangular voltage u_C reaches the potential at R_1 . This condition is stable and the comparator is balanced.
If a voltage more positive than $-5 V$ is applied to transistor U3/339 from potentiometer START LEVEL via point 8/U3, this voltage determines the voltage at R_1 (U3/659 + 660).
The voltage at C becomes the same potential. In this way any start potential for the triangular signal is possible.

3.1.3. Control unit U5

The control unit supplies the charging currents for the oscillator.

The control unit fig. 22 consists of:

- a current source for potentiometer FREQUENCY,
- two pairs voltage-current converters,
- four current mirrors,
- a symmetry-control stage and
- a single-shot logic.

- 3.1.3.1. The current supplied by power source U5/311 determines the voltage at potentiometer FREQUENCY. By means of potentiometer FREQ. OFFSET the emitter resistance U5/646 of power source 311 and, as a result of this, the voltage at potentiometer FREQUENCY can be changed by $\pm 5 \%$. The frequency ranges 1 Hz to 1 M are adjustable via potentiometers U2/601 to 607.
- 3.1.3.2. Voltage-current converters U5/351 and U5/352 are controlled by the voltage between input SWEEP IN and potentiometer FREQUENCY. The emitters of transistors 301 and 305 are brought to the same potential difference by feedback.
The frequency-determining resistor $R = (U2/608 \text{ to } 611 \text{ and } 614||616||628) \text{ or } (617 \text{ to } 620)$ which is selectable with switch FREQ. MULTIPL., is located between these two emitters.
The last mentioned resistor series applies for the time-asymmetric operation, the switch-over being performed by U1/I. Resistor R determines the emitter currents and consequently the collector currents of transistors U5/301 and U5/305, which correspond to the charging currents I_C and I_C^* (fig. 7).

Equal transistor U5/303 is located in the feedback path to reduce the load effects of the inverting inputs of an amplifier U5/351 and 352. By means of resistor U5/605||606 the offset voltage at the output of the voltage-current converter is adjusted to zero between the emitter connections of U5/301 and 305.

Diode U5/401 limits the voltage at the input SWEEP IN to 12 V maximum.

For time-asymmetrical operation (duty cycle 0.1 or 0.9) two different charging currents are required. For this, the control unit contains another pair of voltage-current converters (U5/353, 354, 312, 314, 316), which is controlled by the same differential voltage. Amplifier pair U5/353, 354 is electrically identical to pair U5/351/352 and adjusted correspondingly.

The resistors on wafer 4, switch U2, which determine charging time and frequency, have twice the value of the corresponding resistors on wafer 2, switch U2. The output currents $\pm 0,5 \cdot I$ obtained are amplified by 10 in two current mirrors U5/317-320 and made $\pm 5 I$.

For asymmetrical operation voltage-current converters U5/351, 352 supply currents $\pm 5 I/9$ via the corresponding current mirrors.

In this case resistors U2/617 to 620 are used whose values are 9/5 higher than those of the corresponding resistors U2/608 to 611.

- 3.1.3.3. The output currents of the voltage-current converters are "reflected" by each a current-mirror pair in ratio 1:1 or 10:1 and supplied to the oscillator. The current mirrors are mainly made of a series diode (e.g. U5/306) and resistor; see example in fig. 8.

The collector current I_{IN} of voltage-current converter U5/301 flows through the current mirror. The resulting voltage drop controls a current back fed emitter-stage, e.g. U5/305, which supplies the output current I_{OUT} .

Assume the current-voltage characteristics of e.g. diode U5/306 (transistor used as diode) and the emitter-base diode of the output transistor (e.g. U5/308) are identical as well as their relevant resistors. The ratio I_{IN}/I_{OUT} then is 1:1; otherwise, the current ratio I_{OUT}/I_{IN} is inversely proportional to the resistance ratio.

The practical differences of the input diodes and the differences in resistances are compensated by potentiometer (e.g. fig. 8, U5/620). The built-in potentiometer supplies a correcting voltage, causing a correcting current superimposition.

The base currents which interfere at low values ($I_{IN} \leq 10 \text{ mA}$) are every time neutralized by potentiometers U5/628, 629, 672, 673.

- 3.1.3.3.1. The current mirror U5/308, 307 is used for time-symmetrical operation. The collector current of transistor U5/308 operates as frequency-determining charging current I_C for the oscillator from the positive direction. Zener diodes U1/423, 424 reduce the power dissipation.

The relevant charging current I_C^* for the oscillator is supplied by voltage-current converter U5/352, 305 via U5/307.

This current mirror forms the reference for current mirror U5/308, which is adjusted by symmetry control U5/310, 327, 328 to $I_C = I_C^*$ (see 3.1.3.4.). The accuracy of the current mirror for I_C^* determines the frequency accuracy for time-symmetrical operation; maximum adjustment is obtained by means of U5/625 and 629.

- 3.1.3.3.2. Current-mirror pair U5/319, 320 amplifies the input current 10 times, which corresponds to the ratio of resistances U5/660 to 675 or U5/661 to 676. These current mirrors are adjusted by potentiometers U5/665, 670. The Zener diode reduce the power dissipation.

- 3.1.3.4. Symmetry control U5/310 adjusts the charging current automatically to I_C^* for time-symmetrical operation.

The symmetry control is driven by the voltage applied between zero potential and the smallest potential to earth of the oscillator capacitor, whose galvanic zero is disconnected by switch U1/V1 for symmetrical operation. The control loop keeps this potential difference at a constant value near zero.

This means that I_C and I_C^* are equal.

- 3.1.3.5. The single-shot logic contains a flip-flop (U5/325 and 326).

The latter can be set to OFF or START by means of switch SINGLE SHOT MODE; it can be set by input signal CONTROL INPUT (at the rear) and reset by the square-wave signal from the oscillator.

When switch SINGLE SHOT MODE is set to SET PHASE, the static blockade at point U5/7 is cancelled, so that the flip-flop is reset by the first positive-going square-wave at point U5/C and U5/321-322.

If the oscillator u_R is kept to -5 V (see 3.1.2.8.) via point U5/X, the potential of which jumps from 0 to -5 V when switching-over. The potentials at points U5/6 and 4 jump simultaneously from negative values to -5 V and $+5 \text{ V}$ respectively. The start potential of the triangular voltage is adjustable within this voltage range by means of potentiometer SET PHASE.

By setting switch SINGLE SHOT MODE from SET PHASE to START, a trigger pulse appears at U5/513 to set the flip-flop.

Diode U5/419 avoids multiple triggering as a result of bouncing contacts of switch START.

The flip-flop can also be set by a negative voltage jump of 5 V at the CONTROL INPUT (connection U5/X = 0 V). Due to this a voltage is available at connection X and the oscillator is start. However, the first positive-going square-wave resets the flip-flop again, so that oscillation stops after one cycle.

Potentiometer SET PHASE is adjusted by means of potentiometers U5/679, 682.

U5/682 serves to adjust the positive part and U5/679 the negative part of the square-wave. Both adjusting operations are interdependent.

3.1.4. Sine-shaper Unit U4

The sine-shaper consists of:

- a diode-resistor network
- a circuit for peak compensation
- a delay section to start peak compensation at the right time
- an inverting wide-band amplifier

3.1.4.1. The diode-resistor network fig. 22 converts a triangular signal of $10 V_{pp}$ into a sine-wave signal with an amplitude of $5V \cdot 2/\pi = 3,18 V$.

Each diode (U4/401 to 414) is biased by a different voltage from one voltage divider each (U4/601, 604 to 619 and 603, 606 to 621).

They function as amplitude-dependent switches and are increasingly connecting in parallel with resistors U4/605, 608, 611, 614, 617 and 620 at rising triangular voltage. Magnitude and symmetry of the diode bias is determined by two voltage sources U4/351 and 313 to 315, which are coupled to better the temperature compensation. Adjustment is performed by means of U4/666, 669.

The diodes with the highest bias voltage U4/413 and 414 serve to form the sine-wave tops. They should form, together with the corresponding voltage source, an extremely low-ohmic current path. As this only can be approximated due to the forward resistance of the diodes, the peaks obtained are cut-off by a compensating circuit.

3.1.4.2. The peak-compensating circuit consists of transistors U4/301, 302, 303 and 305.

Diodes U4/413, 414 are biased by U4/301, 302 in such a way, that they only conduct during the period the tops of the sine-wave are formed.

The peak compensation takes over the current by means of transistors U4/301 and 302 respectively via diodes U4/413 and 414. Stages U4/303 and 305 respectively amplify and invert the current, which is then supplied to the summing point at resistor 640.

3.1.4.3. The delay circuit in signal path U4/504 to 506; 636, 751, 752 compensates the phase delay of the peak compensation at frequencies higher than 1 MHz.

Due to its low-pass characteristic this delay circuit causes the distortion factor to be decreased for frequencies higher than 1 MHz.

3.1.4.4. In wide-band amplifier U4/307 to 312 the voltage loss of $2/\pi$ caused by the sine-shaper is compensated by amplifying $V = -\pi/2$.

Consequently the sinewave signal at the output has the same peak value as the triangular input voltage.

The DC-offset of the output voltage is adjusted by U4/644, while the frequency response for range 1 to 10 MHz is adjusted by U4/508.

3.1.5. Power amplifier Unit U6

The power amplifier fig. 22 is complementary and symmetrically arranged and contains:

- an emitter-follower stage
- a voltage-amplifying cascode part
- a driver stage
- an A/B - power output stage U6/309, 310
- elements for a DC OFFSET-control
- an OVERRANGE indicator

- 3.1.5.1. The emitter-follower stage U6/301, 302 acts as an impedance converter.
- 3.1.5.2. The cascode part U6/303, 305; 304, 306 inverts and amplifies the voltage. The amplification is adjusted with potentiometer U6/626, while the symmetry is adjusted by means of U6/624. The total gain (no load operation) amounts to 4.4. The bandwidth then is ca. 56 MHz which corresponds to a rise time of ca. 20 ns (see fig. 9). The amplitude response and the step function response is optimally compensated by U6/751 and 507 (see fig. 9).
- 3.1.5.3. The driver stage consists of emitter-followers U6/307, 308.
- 3.1.5.4. The power output stage operates in AB mode. The output impedance is very low and is terminated by ca. $50\ \Omega$ by means of both series resistors U6/636, 637. A symmetrical adapted attenuator 607, 608, 609 is active when setting knob 0 dB/–20 dB to –20 dB.
- 3.1.5.5. The d.c. offset voltage to be superimposed to the output signal is fed to the input of the cascode part via resistor U6/608. Switch DC OFFSET serves to reverse polarity, while relevant potentiometer DC OFFSET enables the offset voltage to be adjusted continuously.
- 3.1.5.6. Indicator OVERRANGE U6/351 and lamp 821 indicates overrange of the output amplifier. Tandem potentiometers 604b, 604a and 603b, 603a produce d.c. voltages proportional to the momentary values of signal amplitude and DC OFFSET. These d.c. voltages are added via U6/641, 642, 640. Operational amplifier U6/351 compares the resulting voltage with the fixed reference voltage at U6/643, 644. As soon as the threshold value of signal and DC OFFSET 30 V, set by potentiometers AMPLITUDE and DC OFFSET, is exceeded, the comparator amplifies the signal and lamp 821 lights. At lower frequencies, indicator OVERRANGE lights beforehand and warns for the expected overrange by operating potentiometers AMPLITUDE or DC OFFSET.

3.1.6. DC Supply unit U7

The DC supply unit fig. 15 contains two independent and complementary power supplies for a positive and a negative d.c. voltage of 30 V each. The output voltage of each power supply is kept constant by means of a voltage regulation circuit.

- 3.1.6.1. The voltage regulation circuit for the positive supply voltage consists of:
- an adjustable voltage divider, U7/608/610||609
 - a set point section, consisting of U7/412, 607
 - a voltage regulator, consisting of an amplifier U7/351 used as integrator
 - a regulating element consisting of a driver transistor U7/301 and a series transistor 351 at the rear of the instrument.
 - a low-pass filter
- 3.1.6.2. A current regulating-circuit takes over the function of the voltage regulating-circuit. It limits the charging current to a maximum value in case of inadmissible low load resistances (e.g. short-circuit). The current regulating-circuit for the positive supply voltage consists of:
- a resistor U7/603, which measures the actual current
 - a stage U7/302, which determines the max. load current and at the same time serves as a reference (base-emitter voltage)
 - a regulating element and a low-pass filter, identical to those of the voltage regulating-circuit.

The regulating circuits for the negative supply voltage are arranged accordingly.

The supply voltages are adjusted by means of resistors U7/610 and U7/630.

3.2. GAINING ACCESS TO THE PARTS

3.2.1. Cabinet

The upper and lower plates are fixed to the rear by means of 2 screws each.

3.2.2. Knobs

- Remove the cap from the knob
- Unscrew the nut and remove the knob
- When mounting the knob back, make sure that the white marks appear at the correct side

3.2.3. Textplate

- Remove upper and bottom plate
- Remove all knobs
- Carefully remove the ornamental strips
- Remove lamps **OVERRANGE (821)** and **POWER (820)** from the holder; therefore, slightly shift the textplate to the front
- Remove the textplate

3.3. GENERAL CHECK, ADJUSTING AND CHECKING

- The tolerances mentioned in this chapter only apply for a newly adjusted instrument and can deviate from the values mentioned in chapter 1.2. TECHNICAL DATA.
- The instrument only must be adjusted after a warming-up of at least 30 minutes at an ambient temperature of $+(23\pm 3)$ °C.
- The adjustment of Frequency Switch Unit U2 and Control Unit U5 must be performed with completely closed instrument; if necessary, the instrument must be newly warmed-up after an adjusting procedure. The remaining units must possibly be performed with closed instrument; in no case, use an extension p.w.b.
- If not indicated differently:
 - the voltages, given in this chapter, are measured with respect to the signal earth (\perp)
- The following abbreviations are used for the various measuring instruments:

L	= open	
Q	= oscilloscope with an input impedance of $50 \Omega^*$	e.g. PHILIPS PM 3250
Z	= counter	e.g. PHILIPS PM 6620
V	= digital voltmeter (d.c.)	e.g. PHILIPS PM 2441
AC-V	= AC-milivoltmeter	e.g. PHILIPS PM 2454B
K	= distorsiometer	e.g. Hewlett Packard, type 334A
G	= generator	e.g. PHILIPS PM 5126
50Ω	= load resistor 50Ω , 3 W	e.g. PHILIPS PM 9581
1 nF	= capacitor 1 nF	

* Measuring cable terminated with 50Ω at the side of the oscilloscope.

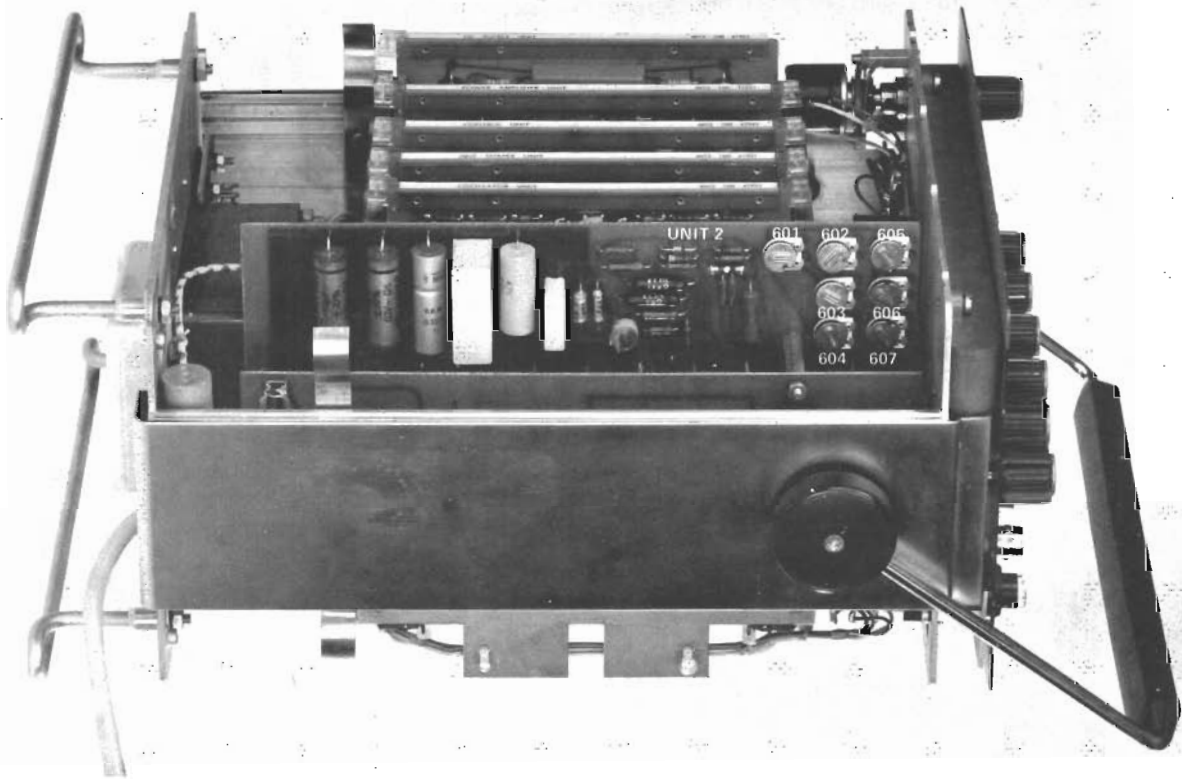

Fig. 10. Adjusting elements on UNIT 2

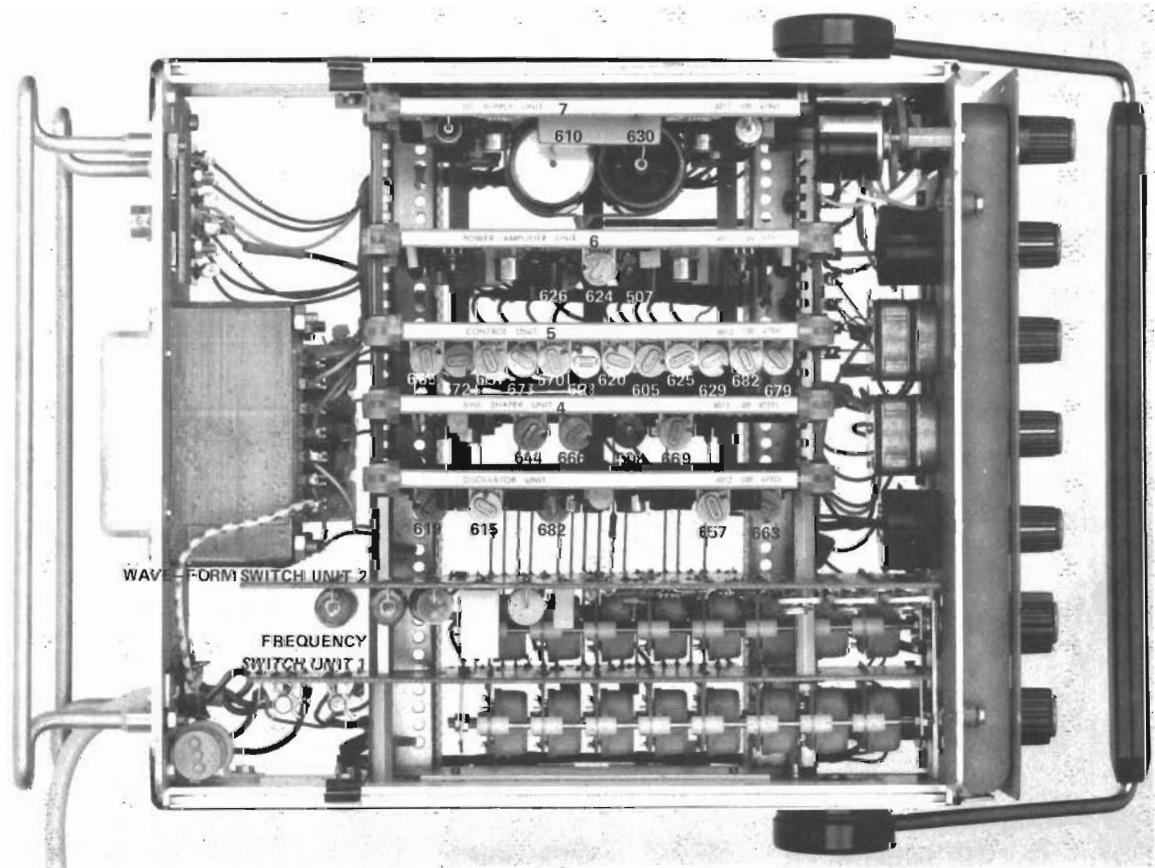

Fig. 11. Adjusting elements on UNIT 2 up to UNIT 7

3.4. HINTS FOR FAULT-FINDING

In order to facilitate the fault-finding, figures 14 and 22 show the voltage values, which are measured by means of a Philips universal measuring instrument PM 2411. All measuring values only apply for the following adjustments to:

WAVEFORM	(802)	~
FREQUENCY Hz	(601)	10
FREQ. MULTIPL.	(803)	100
FREQ. OFFSET	(602)	0
DC OFFSET	(603)	0
AMPLITUDE	(604)	20 V _{pp}
SET PHASE	(605)	0
DC OFFSET	(804)	0
0 dB/-20 dB	(805)	-20 dB
SINGLE SHOT	(806)	OFF
RUN/HOLD	(807)	RUN

Remark: All voltage indications only serve as information.

If necessary, an extension plug-in board can be used for each board in view of fault-finding.

Before replacing a component, the instrument must be switched off. After replacement, it is required to readjust the relevant circuit in accordance with Chapter 3.3.

3.5. PARTS LIST

3.5.1. Mechanical

<i>Item</i>	<i>Fig.</i>	<i>Quantity</i>	<i>Order number</i>	<i>Description</i>
1	12	1	5322 447 94351	Top cover
2	12	1	5322 447 94351	Bottom cover
3	12	1	5322 460 64002	Ornamental frame
4	12	1	5322 455 74032	Text plate
5	12	1	5322 450 34025	Scale assembly
6	12	2	5322 460 64003	Ornamental strip
7	12	1	5322 414 34136	Control knob
8	12	1	5322 414 74019	Cap for control knob (item 7)
9	12	4	5322 414 34082	Control knob
10	12	6	5322 414 74014	Cap for control knob (items 9 and 11)
11	12	2	5322 414 34079	Switch knob
12	12	1	5322 276 14128	Mains switch
13	12	4	5322 267 10004	BNC-connector
14	12			
15	13	4	5322 532 50824	Insulating ring
16	12			
17	13	1	5322 277 10205	Toggle switch +DC OFFSET/0/-DC OFFSET
18	12			
19	12	1	5322 277 10269	Toggle switch OFF/SET PHASE/START
20	12	1	5322 277 10214	Toggle switch RUN/HOLD
21	12	1	5322 277 10169	Toggle switch 0 dB/-20 dB
22	12	1	5322 498 54032	Handle assembly
23	12	2	5322 498 74003	Cap for handle
24	12	2	5322 535 74367	Spindle for handle
25	12	1	5322 520 34139	Bearing bush, left
26	—	1	5322 520 34138	Bearing bush, right
27	12	4	5322 462 44121	Foot
28	12	4	5322 492 64338	Spring for foot
29	13	1	5322 268 20051	Socket for cabinet potential
30	13	1	5322 325 50101	Grommet
31	14	4	4822 492 60063	Clamping spring for fuse
32	15	4	5322 532 54056	Disk
33	15			
34	14	46	5322 255 40059	Transistor spacer
35	14	2	5322 255 44064	Heat sink for transistors U6/309 and U6/310
36	14	2	5322 255 44037	Heat sink for transistors U6/305 and U6/306
37	—	2	5322 255 44069	Washer for transistors U6/309 and U6/310
38	14	8	5322 255 40064	IC-holder for U4/351, U5/351-354, U6/357, U7/351-352.
39	15	4	5322 267 60023	Connector (22-pole)
40	14	9	5322 466 94276	Clip
41	14	1	5322 466 94311	Suspension for potentiometer
42	15	1	5322 267 60023	Connector (44-pole)
43	14	1	5322 462 34124	Guide part
44	14	9	5322 462 34118	Guide part
45	—	5	5322 268 94013	Key
46	14	2	4822 255 40111	Insulating bush
47	14	1	5322 255 44177	Washer
48	14	2	4822 255 40112	Mica plate
49	14	4	5322 405 94072	Spacer
50	14	2	5322 405 94275	Spacer
51	14	1	5322 405 94071	Spacer

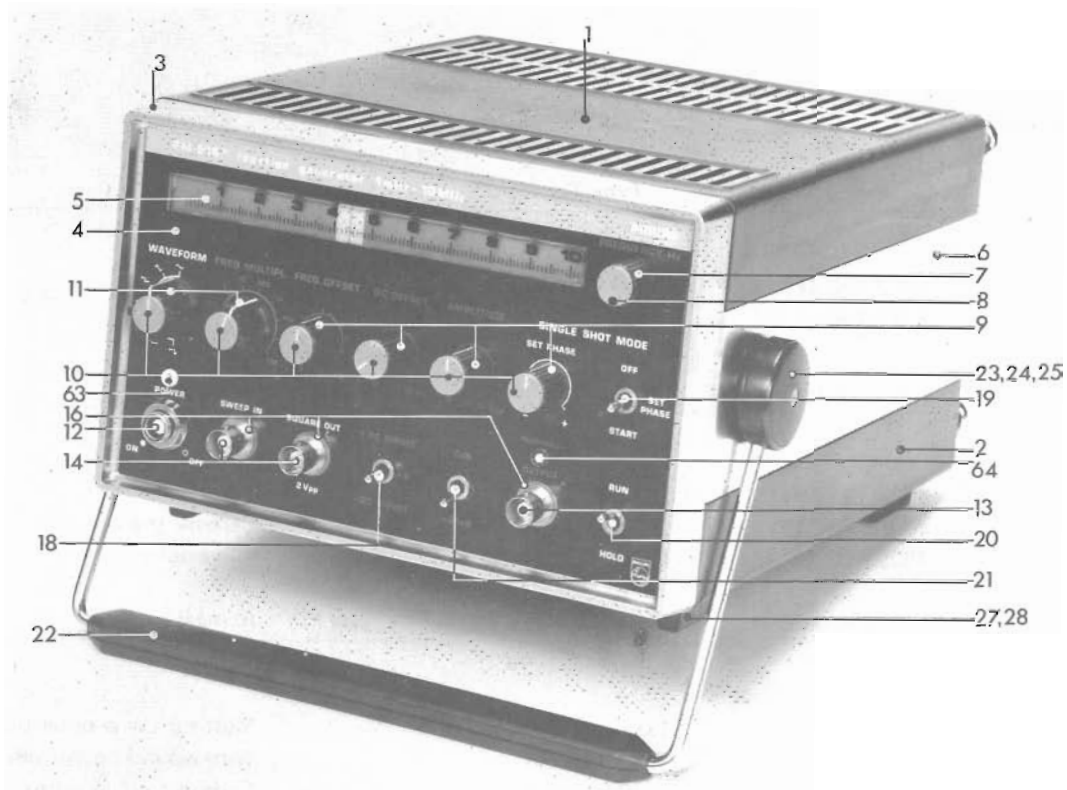

Fig. 12. Front view, mechanical components

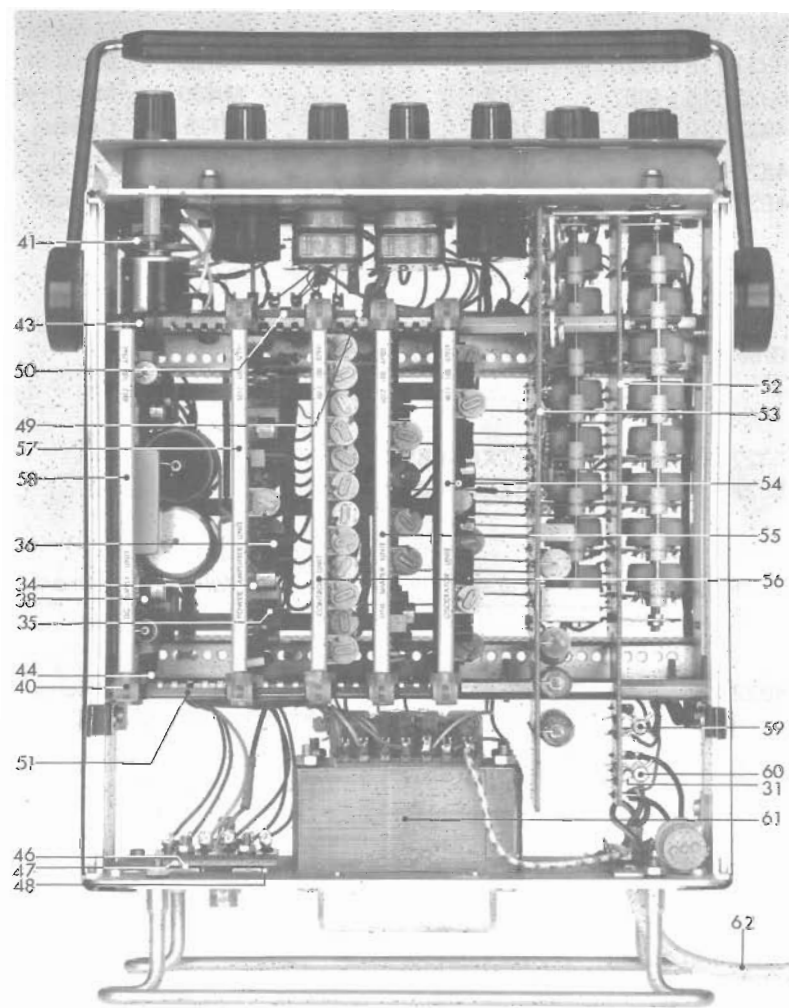

Fig. 14. Top view, mechanical components.

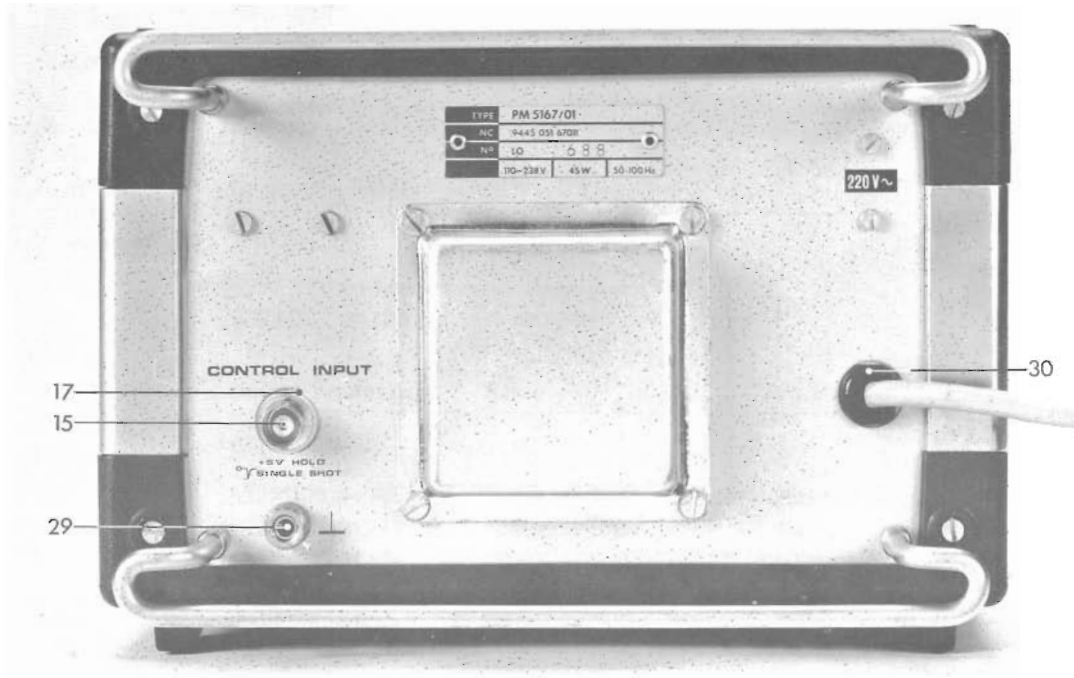

Fig. 13. Rear view, mechanical components.

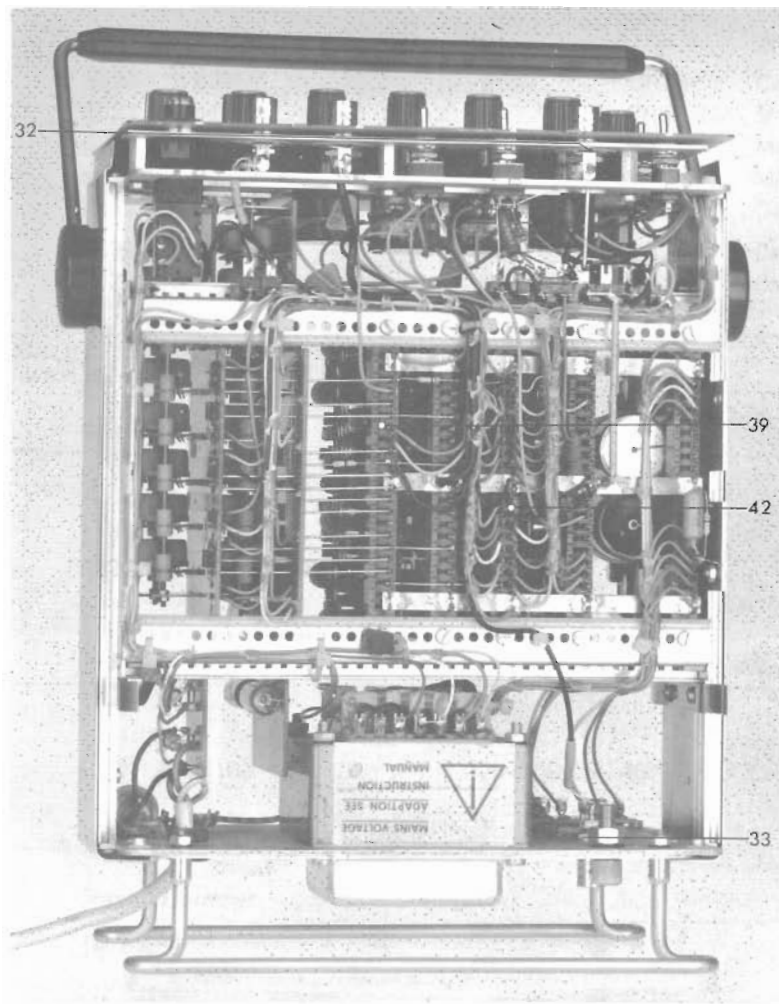

Fig. 15. Bottom view, mechanical components.

3.5.2. Electrical

3.5.2.1. Not on units

<i>Item</i>	<i>Ordering number</i>	<i>Type/Description</i>
Transistors		
304	5322 130 44325	BD 203
324	5322 130 44324	BD 204

<i>Item</i>	<i>Ordering number</i>	<i>Farad</i>	<i>Tol. (%)</i>	<i>Volts</i>	<i>Remarks</i>
Capacitors					
501	5322 121 44115	2x2,5 N	20	250	
502	4822 122 31211	100 p	20	400	Ceramic plate
503	4822 120 41134	10 n	10	400	Polyester

<i>Item</i>	<i>Ordering number</i>	<i>Ohm</i>	<i>Tol. (%)</i>	<i>Type</i>	<i>Remarks</i>
Resistors					
601	5322 103 54018	1.0 k	5		Multiturn w-w potentiometer
602	5322 103 20087	100	10		Wire-wound potentiometer
603	5322 102 34009	2x10 k			Carbon tandem potm.
604	5322 102 34011	10 k - 500			Carbon tandem potm.
605	5322 103 20092	2.2 k	10		Wire-wound potentiometer
606	4822 110 63058	15	5	CR25	Carbon
607	5322 116 54893	43	5	PR52	Metal film
608	5322 116 50926	40.2	1	MR25	Metal film
609	5322 116 54887	10.2	1	MR30	Metal film
610	4822 110 63161	100 k	5	CR25	Carbon
611	4822 110 63063	22	5	CR25	Carbon
612	4822 110 63161	100 k	5	CR25	Carbon

3.5.2.2. Wave-form switch Unit 1

<i>Item</i>	<i>Ordering number</i>	<i>Type/Description</i>
Diodes		
421-422	5322 130 34115	BZX61-C8V2
423-424	5322 130 34167	BZX79-C6V2

<i>Item</i>	<i>Ordering number</i>	<i>Farad</i>	<i>Tol. (%)</i>	<i>Volts</i>	<i>Remarks</i>
Capacitors					
501-502	4822 122 30103	22 n	-20+100	40	Ceramic plate

3.5.2.3. Frequency switch unit 2

<i>Item</i>	<i>Ordering number</i>	<i>Type/Description</i>
Diodes		
423	5322 130 34278	BZX79-C6V8

<i>Item</i>	<i>Ordering number</i>	<i>Farad</i>	<i>Tol. (%)</i>	<i>Volts</i>	<i>Remarks</i>
Capacitors					
501-502 } 503-504 {	5322 121 44056	10 μ	10	63	Polyester foil
505	5322 121 40173	6.8 μ	20	63	Polyester foil
506	5322 121 40224	4.7 μ	10	100	Polyester foil
507	5322 121 40175	470 n	10	100	Polyester foil
508	5322 121 54108	47 n	5	63	Polystyrene foil
509	4822 121 50539	4.7 n	5	63	Polystyrene foil
510	5322 121 54129	430 p	5	250	Polystyrene foil
512	4822 125 50062	2-10 p		100	Trimmer

<i>Item</i>	<i>Ordering number</i>	<i>Ohm</i>	<i>Tol. (%)</i>	<i>Type</i>	<i>Remarks</i>
Resistors					
601-607	5322 101 14008	2,2 k	20	0.5 W	Carbon potentiometer
608	5322 116 54237	1 M	0.1	0.75 W	Metal film
609	5322 116 54155	100 k	0.1	0.4 W	Metal film
610	5322 116 50748	10 k	0.1	0.4 W	Metal film
611	5322 116 54549	1.0 k	0.1	0.4 W	Metal film
614	5322 116 50747	1.0 k	1	0.4 W	Metal film
616	5322 116 50556	4.42 k	1	MR25	Metal film
617	5322 116 54885	1.8 M	0.1	0.75 W	Metal film
618	5322 116 54891	180 k	0.1	0.5 W	Metal film
619	5322 116 50907	18 k	0.1	0.4 W	Metal film
620-622	5322 116 50006	1.8 k	0.1	0.4 W	Metal film
623	5322 116 54886	2.0 M	0.1	0.75 W	Metal film
624	5322 116 54892	200 k	0.1	0.5 W	Metal film
625	5322 116 54888	20 k	0.1	0.4 W	Metal film
626	5322 116 54064	2.0 k	0.1	0.4 W	Metal film
628	4822 116 30025	150 k	10	0.6 W	NTC
629	5322 116 50491	22,6	1	MR25	Metal film (resistor 611 in version -/05, not on units)

3.5.2.4. Oscillator Unit U3

<i>Item</i>	<i>Ordering number</i>	<i>Type/Description</i>
Transistors		
301	5322 130 44322	BCY79/IX
302	5322 130 44073	BCY59/IX
303	4822 130 40937	BC548B
304	5322 130 44237	BF450
305	5322 130 44197	BF558B
306-307-308	5322 130 44197	BF450
309-310-311	5322 130 44197	BC558B
311		
312-313	4822 130 44937	BC548B
314	5322 130 44322	BCY79/IX
315	5322 130 44321	BFW11, Sel. pair + clip

<i>Item</i>	<i>Ordering number</i>	<i>Type/Description</i>
316-317-318 } 319-320-321 }	5322 130 44322	BCY79/IX
322	4822 130 40937	BC548B
323-324	5322 130 44321	BFW11, Sel. pair + clip
325	5322 130 44322	BCY79/IX
326	5322 130 44073	BCY59/IX
327	5322 130 44322	BCY79/IX
328	5322 130 44197	BC558B
329-330-331	4822 130 40902	BF240
332-333	4822 130 40937	BC548B
334	4822 130 40902	BF240
335-336	4822 130 40937	BC548B
337-338	5322 130 44197	BC558B
339	5322 130 40408	BFW11
340-341	5322 130 44322	BCY79/IX
342-343-344 } 345-346-347 } 348-349-350 }	5322 130 44073	BCY59/IX
351	5322 130 44197	BC558B
352	5322 130 44073	BCY59/IX

Diodes

413-406-407 } 418-409-410 }	5322 130 40182	BAX13
411-452	5322 130 34281	BZX79-C15
413	5322 130 44286	BZX79-C18
414-455-458	5322 130 34281	BZX79-C15
419-460-461	5322 130 44286	BZX79-C18
412-464	5322 130 34281	BZX79-C15
415-466	4822 130 30773	BZX79-C4V7

<i>Item</i>	<i>Ordering number</i>	<i>Farad</i>	<i>Tol. (%)</i>	<i>Volts</i>	<i>Remarks</i>
Capacitors					
511-502 } 513-504 }	4822 122 30103	22 n	-20+100	40	Ceramic plate
515	4822 122 31205	47 p	20	400	Ceramic plate
516-507	4822 122 30103	22 n	-20+100	40	Ceramic plate
518	4822 122 31199	22 p	5	400	Ceramic plate
519	4822 122 30103	22 n	-20+100	40	Ceramic plate
510-511-512 } 513-514-515 } 516-517-518 }	4822 122 30103	22 n	-20+100	40	Ceramic plate

<i>Item</i>	<i>Ordering number</i>	<i>Ohm</i>	<i>Tol. (%)</i>	<i>Type</i>	<i>Remarks</i>
Resistors					
611-602	5322 116 50747	1.0 k	1	MR25	Metal film
613-604	5322 116 54469	100	1	MR25	Metal film
615-606	5322 116 50747	1.0 k	1	MR25	Metal film
617	5322 116 50524	3.01 k	1	MR25	Metal film

<i>Item</i>	<i>Ordering number</i>	<i>Ohm</i>	<i>Tol. (%)</i>	<i>Type</i>	<i>Remarks</i>
608	5322 116 50484	4.64 k	1	MR25	Metal film
609	5322 116 54589	3.83 k	1	MR25	Metal film
610-611	5322 116 50524	3.01 k	1	MR25	Metal film
612	5322 116 54547	953	1	MR25	Metal film
613	5322 116 50484	4.64 k	1	MR25	Metal film
614	5322 116 50586	1.54 k	1	MR25	Metal film
615	5322 101 14051	220	20	0.5 W	Carbon potentiometer
616	5322 116 54549	1.0 k	1	MR25	Metal film
617	5322 116 50482	33.2 k	1	MR25	Metal film
618	5322 116 50726	36.5 k	1	MR25	Metal film
619	5322 101 14051	220	20	0.5 W	Carbon potentiometer
620	5322 116 54648	24.9 k	1	MR25	Metal film
621	5322 116 50671	2.61 k	1	MR25	Metal film
622	5322 116 54228	1.78 k	1	MR25	Metal film
623	5322 116 54615	9.09 k	1	MR25	Metal film
624	5322 116 50583	5.9 k	1	MR25	Metal film
625	5322 116 54455	68.1	1	MR25	Metal film
626	5322 116 54228	1.78 k	1	MR25	Metal film
627	5322 116 54455	68.1	1	MR25	Metal film
628	5322 116 50484	4.64 k	1	MR25	Metal film
629	5322 116 50586	1.54 k	1	MR25	Metal film
630	5322 116 50672	51.1 k	1	MR25	Metal film
631-632	5322 116 50524	3.01 k	1	MR25	Metal film
633	5322 116 50484	4.64 k	1	MR25	Metal film
634	5322 116 54589	3.83 k	1	MR25	Metal film
635	5322 116 54228	1.78 k	1	MR25	Metal film
636	5322 116 54619	10 k	1	MR25	Metal film
637-638	5322 116 54489	169	1	MR25	Metal film
639-640	5322 116 50747	1.0 k	1	MR25	Metal film
641	5322 116 54469	100	1	MR25	Metal film
642-643	5322 116 50747	1.0 k	1	MR25	Metal film
644-645	5322 116 54469	100	1	MR25	Metal film
646-647	5322 116 50747	1.0 k	1	MR25	Metal film
648	5322 116 54504	274	1	MR25	Metal film
649	5322 116 54455	68.1	1	MR25	Metal film
650	5322 116 54589	3.83 k	1	MR25	Metal film
651	5322 116 50484	4.64 k	1	MR25	Metal film
652-653	5322 116 50524	3.01 k	1	MR25	Metal film
654	5322 116 54547	953	1	MR25	Metal film
655	5322 116 50586	1.54 k	1	MR25	Metal film
656	5322 116 50484	4.64 k	1	MR25	Metal film
657	5322 101 14051	220	20	0.5 W	Carbon potentiometer
658	5322 116 54549	1.0 k	1	MR25	Metal film
659	5322 116 54506	287	1	MR25	Metal film
660	5322 116 54455	68.1	1	MR25	Metal film
661	5322 116 50482	33.2 k	1	MR25	Metal film
662	5322 116 50726	36.5 k	1	MR25	Metal film
664	5322 101 14051	220	20	0,5 W	Carbon potentiometer
665	5322 116 54648	24.9 k	1	MR25	Metal film
666	5322 116 50608	6.19 k	1	MR25	Metal film
667	5322 116 54455	68.1	1	MR25	Metal film
668	5322 116 54228	1.78 k	1	MR25	Metal film
669	5322 116 54455	68.1	1	MR25	Metal film
670	5322 116 50583	5,9 k	1	MR25	Metal film
671	5322 116 54615	9.09 k	1	MR25	Metal film
672	5322 116 54228	1.78 k	1	MR25	Metal film
673	5322 116 50608	6.19 k	1	MR25	Metal film

<i>I em</i>	<i>Ordering number</i>	<i>Ohm</i>	<i>Tol. (%)</i>	<i>Type</i>	<i>Remarks</i>
674	5322 116 50586	1.54 k	1	MR25	Metal film
675	5322 116 50484	4.64 k	1	MR25	Metal film
676-677	5322 116 50524	3.01 k	1	MR25	Metal film
678	5322 116 54589	3.83 k	1	MR25	Metal film
679	5322 116 50484	4.64 k	1	MR25	Metal film
630	5322 116 54489	169	1	MR25	Metal film
631	5322 116 54469	100	1	MR25	Metal film
632	5322 101 14072	100	20	0.5 W	Carbon potentiometer
€ 83	5322 116 54469	100	1	MR25	Metal film
€ 84-685	5322 116 50747	1.0 k	1	MR25	Metal film
€ 86-687	5322 116 54619	10 k	1	MR25	Metal film
€ 88-689-690					
€ 91	5322 116 50621	536	1	MR25	Metal film

3.5.2.5. Sine-shaper Unit U4

<i>I em</i>	<i>Ordering number</i>	<i>Type/Description</i>
Transistors		
301	4822 130 40959	BC546A
302-303	5322 130 44462	BC556A
304	5322 130 44197	BC558B
305	4822 130 41067	BC546A
306-307-308	4822 130 40937	BC548B
309	5322 130 44322	BCY79/IX
310	5322 130 44073	BCY59/IX
311	4822 130 40937	BC548B
312	5322 130 44197	BC558B
313	4822 130 40937	BC548B
314-315	5322 130 44322	BCY79/IX
Integrated circuits		
351	5322 209 84452	μA709HC
Diodes		
401-402-403	5322 130 34321	1N4151
404-405-406		
407-408-409		
410-411-412		
413-414	5322 130 40182	BAX13
415-416-417		
418-419-420	5322 130 34047	BZX75-C1V4
431-452		
433-454-455	5322 130 34281	BZX79-C15

<i>I em</i>	<i>Ordering number</i>	<i>Farad</i>	<i>Tol. (%)</i>	<i>Volts</i>	<i>Remarks</i>
Capacitors					
511-502	4822 122 31195	10 p	5	400	Ceramic plate
513	4822 122 31177	470 p	-20/+50	400	Ceramic plate
514	4822 122 31047	5.6 p	0.25	100	Ceramic plate
515-506	4822 122 31067	33 p	2	100	Ceramic plate
517	4822 122 31177	470 p	-20/+50	400	Ceramic plate
518	5322 125 54009	4.5-26 p		50	Trimmer
510-511	4822 122 30103	22 n	-20/+100	40	Ceramic plate
512-514					

<i>Item</i>	<i>Ordering number</i>	<i>Farad</i>	<i>Tol. (%)</i>	<i>Volts</i>	<i>Remarks</i>
515-516 517-518	} 4822 122 30043	10 n	-20/+100	40	Ceramic plate
519	4822 122 30103	22 n	-20/+100	40	Ceramic plate
521	4822 122 30128	4.7 n	10	100	Ceramic plate
522	4822 122 31173	220 p	10	100	Ceramic plate
523	4822 122 30128	4.7 n	10	100	Ceramic plate
524	4822 122 30103	22 n	-20/+100	40	Ceramic plate
525	4822 122 31036	2,2 p	0,25 p	100	Ceramic plate
<i>Item</i>	<i>Ordering number</i>	<i>Ohm</i>	<i>Tol. (%)</i>	<i>Type</i>	<i>Remarks</i>

Resistors

601	5322 116 50409	36.5	1	MR25	Metal film
602	5322 116 50766	147	1	MR25	Metal film
603	5322 116 50409	36.5	1	MR25	Metal film
604	5322 116 50511	48.7	1	MR25	Metal film
605	5322 116 50767	2.15 k	1	MR25	Metal film
606	5322 116 50511	48.7	1	MR25	Metal film
607	5322 116 50409	36.5	1	MR25	Metal film
608	5322 116 50842	1.1 k	1	MR25	Metal film
609	5322 116 50409	36.5	1	MR25	Metal film
610	5322 116 50493	27.4	1	MR25	Metal film
611	5322 116 54541	825	1	MR25	Metal film
612	5322 116 50493	27.4	1	MR25	Metal film
613	5322 116 50473	19.6	1	MR25	Metal film
614	5322 116 50459	422	1	MR25	Metal film
615	5322 116 50473	19.6	1	MR25	Metal film
616	5322 116 50412	14.7	1	MR25	Metal film
617	5322 116 54511	316	1	MR25	Metal film
618	5322 116 50412	14.7	1	MR25	Metal film
619	5322 116 54069	12.1	1	MR25	Metal film
620	5322 116 54464	86.6	1	MR25	Metal film
621	5322 116 54069	12.1	1	MR25	Metal film
622-623	4822 110 63098	470	5	CR25	Carbon
624	4822 110 63134	10 k	5	CR25	Carbon
625-626	4822 110 63081	100	5	CR25	Carbon
627	4822 110 63134	10 k	5	CR25	Carbon
628-629	4822 110 63121	3.3 k	5	CR25	Carbon
630-631	4822 110 63125	4.7 k	5	CR25	Carbon
632-633	4822 110 63121	3.3 k	5	CR25	Carbon
634	4822 110 63123	3.9 k	5	CR25	Carbon
635	4822 110 63116	2.2 k	5	CR25	Carbon
636	5322 116 50536	464	1	MR25	Metal film
637	4822 110 63063	22	5	CR25	Carbon
638	4822 110 63116	2.2 k	5	CR25	Carbon
639	4822 110 63125	4.7 k	5	CR25	Carbon
640	5322 116 50527	33.2	1	MR25	Metal film
641	5322 116 50415	1.15 k	1	MR25	Metal film
643	5322 116 50842	1.1 k	1	MR25	Metal film
644	5322 101 14067	4.7 k	20	0.5 W	Carbon potentiometer
645	5322 116 54653	28.7 k	1	MR25	Metal film
646	5322 116 50559	27.4 k	1	MR25	Metal film
647	4822 110 53112	1.5 k	5	CR37	Carbon
648	5322 116 54469	100	1	MR25	Metal film
649	4822 110 63134	10 k	5	CR25	Carbon
650	5322 116 54469	100	1	MR25	Metal film
651	4822 110 53112	1.5 k	5	CR37	Carbon

<i>I em</i>	<i>Ordering number</i>	<i>Ohm</i>	<i>Tol. (%)</i>	<i>Type</i>	<i>Remarks</i>
652	4822 110 63141	18 k	5	CR25	Carbon
653	4822 110 63134	10 k	5	CR25	Carbon
654-655	4822 110 63063	22	5	CR25	Carbon
656	4822 110 63134	10 k	5	CR25	Carbon
657	4822 110 63141	18 k	5	CR25	Carbon
658	5322 116 54587	3.65 k	1	MR25	Metal film
659	4822 110 63112	1.5 k	5	CR25	Carbon
660	4822 110 63081	100	5	CR25	Carbon
661	5322 116 50511	48.7	1	MR25	Metal film
662	4822 110 63081	100	5	CR25	Carbon
663	4822 110 63112	1.5 k	5	CR25	Carbon
664	5322 116 50559	27.4 k	1	MR25	Metal film
665	5322 116 50524	3.01 k	1	MR25	Metal film
666	5322 101 14049	470	20	0.5 W	Carbon potentiometer
667	4822 110 63141	18 k	5	CR25	Carbon
668	5322 116 50414	2.87 k	1	MR25	Metal film
669	5322 101 14049	470	20	0.5 W	Carbon potentiometer
670	5322 116 50524	3.01 k	1	MR25	Metal film
€ 71	4822 110 63112	1.5 k	5	CR25	Carbon
€ 72	4822 110 63125	4.7 k	5	CR25	Carbon
€ 73	4822 110 63112	1.5 k	5	CR25	Carbon
€ 74	4822 110 63125	4.7 k	5	CR25	Carbon
€ 75-677	4822 110 63107	1.0 k	5	CR25	Carbon
€ 78	5322 116 54587	3.65 k	1	MR25	Metal film

<i>I em</i>	<i>Ordering number</i>	<i>Henry</i>
-------------	------------------------	--------------

Coils

751	5322 158 10276	4.7 μ
752	5322 158 10222	10 μ

3.5.2.6. Control Unit U5

<i>I em</i>	<i>Ordering number</i>	<i>Type/Description</i>
-------------	------------------------	-------------------------

Transistors

301	5322 130 44073	BCY59/IX
302	4822 130 41067	BC546A
303	5322 130 30187	BCY88
304	4822 130 41067	BC546A
305	5322 130 44322	BCY79/IX
306	5322 130 44197	BC558B
307	5322 130 30187	BCY88
308	5322 130 44197	BC558B
310	5322 130 40709	BFS21A
311	4822 130 40937	BC548B
312	5322 130 44073	BCY59/IX
313	4822 130 41067	BC546A
314	5322 130 30187	BCY88
315	4822 130 41067	BC546A
3 6	5322 130 44322	BCY79/IX
3 7	5322 130 44197	BC558B
3 8	5322 130 44323	BCW48B
3 9	5322 130 44197	BC558B

<i>Item</i>	<i>Ordering number</i>	<i>Type/Description</i>
320-321	4822 130 40937	BC548B
322	5322 130 44197	BC558B
323-324	4822 130 40937	BC548B
325-326 } 327-328 }	5322 130 44197	BC558B

Integrated circuits

351-352 } 353-354 }	5322 209 84342	TBA221
------------------------	----------------	--------

Diodes

401	5322 130 34197	BZX79-C12
403-404	5322 130 34281	BZX79-C15
405-406	5322 130 34167	BZX79-C6V2
407-408	5322 130 34233	BZX79-C5V1
410	5322 130 40182	BAX13
413-414	5322 130 34047	BZX79-C6V2
416-417 } 418-419 }	5322 130 40182	BAX13

<i>Item</i>	<i>Ordering number</i>	<i>Farad</i>	<i>Tol. (%)</i>	<i>Volts</i>	<i>Remarks</i>
Capacitors					
501-502	4822 122 30103	22 n	-20/+100	40	Ceramic plate
503-504	4822 122 31175	1.0 n	-20/+50	400	Ceramic plate
507	4822 121 40232	220 n	10	100	Polyester foil
508-509 } 510-511 }	4822 122 31175	1.0 n	-20/+50	400	Ceramic plate
512	4822 122 30103	22 n	-20/+100	40	Ceramic plate
513-514	4822 122 31211	100 p	20	400	Ceramic plate
515-516	4822 122 31175	1.0 n	-20/+50	400	Ceramic plate

<i>Item</i>	<i>Ordering number</i>	<i>Ohm</i>	<i>Tol. (%)</i>	<i>Type</i>	<i>Remarks</i>
Resistors					
601-602	5322 116 50747	1.0 k	1	MR25	Metal film
603	4822 110 63027	1.0	5	CR25	Carbon
605	5322 100 10121	47 k	20	0.5 W	Carbon potentiometer
606	5322 116 54635	16.9 k	1	MR25	Metal film
607	4822 110 63187	1.0 M	5	CR25	Carbon
608-609	5322 116 50747	1.0 k	1	MR25	Metal film
610	5322 116 54743	301 k	1	MR25	Metal film
611	4822 110 63187	1.0 M	5	CR25	Carbon
612	5322 116 54655	30.1 k	1	MR25	Metal film
613	5322 116 54743	301 k	1	MR25	Metal film
614	5322 116 54068	28.7	1	MR25	Metal film
615-616	5322 116 54755	28.7	0.1	0.4 W	Metal film
617	5322 116 50903	24.9	1	MR25	Metal film
618	5322 116 50479	15.4 k	1	MR25	Metal film
619	5322 116 54686	75 k	1	MR25	Metal film
620	5322 100 10116	100 k	20	0.5 W	Carbon potentiometer
621	4822 110 63214	10 M	10	CR25	Carbon
622-623	5322 116 54743	301 k	1	MR25	Metal film
624	4822 110 63214	10 M	10	CR25	Carbon
625	5322 100 10116	100 k	20	0.5 W	Carbon potentiometer
628-629	5322 100 10118	22 k	20	0.5 W	Carbon potentiometer
630	5322 116 50515	1.78 k	1	MR25	Metal film

<i>Item</i>	<i>Ordering number</i>	<i>Ohm</i>	<i>Tol. (%)</i>	<i>Type</i>	<i>Remarks</i>
632	5322 116 50479	15.4 k	1	MR25	Metal film
633	5322 116 54686	75 k	1	MR25	Metal film
634	5322 116 50903	24.9	1	MR25	Metal film
635-636	5322 116 54755	28.7	0.1	0.4 W	Metal film
637	5322 116 50903	24.9	1	MR25	Metal film
638	4822 110 63138	15 k	5	CR25	Carbon
646	5322 116 54547	953	1	MR25	Metal film
647	5322 116 54612	8.45 k	1	MR25	Metal film
649	5322 116 50484	4.64 k	1	MR25	Metal film
650	5322 116 54655	30.1 k	1	MR25	Metal film
651	4822 110 63187	1.0 M	5	CR25	Carbon
652-653	5322 116 50747	1.0 k	1	MR25	Metal film
654	5322 116 54743	301 k	1	MR25	Metal film
655	4822 110 63187	1.0 M	5	CR25	Carbon
656	5322 116 54635	16.9 k	1	MR25	Metal film
657	5322 100 10121	47 k	20	0.5 W	Carbon potentiometer
658	5322 116 54743	301 k	1	MR25	Metal film
659	5322 116 50578	78.7	1	MR25	Metal film
660-661	5322 116 54538	787	1	MR25	Metal film
662	5322 116 50578	78.7	1	MR25	Metal film
663-664	5322 116 50479	15.4 k	1	MR25	Metal film
665	5322 100 10121	47 k	20	0.5 W	Carbon potentiometer
666	4822 110 63214	10 M	10	CR25	Carbon
667-668	5322 116 54743	301 k	1	MR25	Metal film
669	4822 110 63214	10 M	10	CR25	Carbon
670	5322 100 10121	47 k	20	0.5 W	Carbon potentiometer
672-673	5322 100 10118	22 k	20	0.5 W	Carbon potentiometer
675-676	5322 116 50578	78.7	1	MR25	Metal film
677-678	5322 116 50556	4.42 k	1	MR25	Metal film
679	5322 100 10117	2.2 k	20	0.5 W	Carbon potentiometer
681	5322 116 50729	4.22 k	1	MR25	Metal film
682	5322 100 10117	2.2 k	20	0.5 W	Carbon potentiometer
683	5322 116 54547	953	1	MR25	Metal film
684	5322 116 50414	2.87 k	1	MR25	Metal film
685	5322 116 54643	20.5 k	1	MR25	Metal film
686	5322 116 54624	11.5 k	1	MR25	Metal film
687	5322 116 50608	6.19 k	1	MR25	Metal film
688	5322 116 50536	464	1	MR25	Metal film
689	5322 116 54567	1.69	1	MR25	Metal film
690	5322 116 50536	464	1	MR25	Metal film
691	5322 116 54643	20.5 k	1	MR25	Metal film
692	5322 116 54624	11.5 k	1	MR25	Metal film
693	5322 116 54648	24.9 k	1	MR25	Metal film
694	5322 116 54619	10 k	1	MR25	Metal film
695	5322 116 54655	30.1 k	1	MR25	Metal film
696-697	5322 116 54619	10 k	1	MR25	Metal film
698	5322 116 54648	24.9 k	1	MR25	Metal film

3.5.2.7. Power-amplifier Unit U6

<i>Item</i>	<i>Ordering number</i>	<i>Type/Description</i>
Transistors		
301	5322 130 44322	BCY79/1X
302	5322 130 44073	BCY59/1X
303	5322 130 44034	2N2219A
304-305	5322 130 40468	2N2905A
306-307	5322 130 44422	BSX46-10
308	5322 130 40468	2N2905A
309	5322 130 40823	BD139
310	5322 130 40824	BD140

Integrated circuits

351	5322 209 84452	μ A709HC
-----	----------------	--------------

Diodes

401-402	5322 130 34281	BZX79-C15
403-404	5322 130 34049	BZX75-C2V1
405-406 407-408 }	5322 130 34255	BZX61-C9V1
409-410	5322 130 34047	BZX75-C1V4
412-413	5322 130 40182	BAX13

<i>Item</i>	<i>Ordering number</i>	<i>Farad</i>	<i>Tol. (%)</i>	<i>Volts</i>	<i>Remarks</i>
Capacitors					
501-502	4822 122 30103	22 n	-20/+100	40	Ceramic plate
503	4822 122 31202	33 p	10	400	Ceramic plate
504	4822 122 31178	680 p	10	100	Ceramic plate
505	4822 122 30055	330 p	2	63	Ceramic plate
506	4822 122 31195	10 p	10	400	Ceramic plate
507	5322 125 54015	3-13 p		50	Trimmer
508-509	4822 122 31169	1.5 n	20	400	Ceramic plate
510	5322 122 44008	5.6 n	-20/+50	250	Ceramic disk
511	4822 121 40232	220 n	20	100	Polyester foil
512	5322 122 44008	5.6 n	-20/+50	250	Ceramic disk
513	4822 121 40232	220 n	20	100	Polyester foil
514-515	5322 122 44008	5.6 n	-20/+50	250	Ceramic disk
516	4822 121 40232	220 n	20	100	Polyester foil
517	5322 122 44008	5.6 n	-20/+50	250	Ceramic disk
518	4822 121 40232	220 n	20	100	Polyester foil
519	5322 122 44008	5.6 n	-20/+50	250	Ceramic disk
520	4822 122 31173	220 p	20	400	Ceramic plate

<i>Item</i>	<i>Ordering number</i>	<i>Ohm</i>	<i>Tol. (%)</i>	<i>Type</i>	<i>Remarks</i>
Resistors					
601	4822 110 63072	47	5	CR25	Carbon
602	4822 110 63161	100 k	5	CR25	Carbon
603-604	4822 110 53118	2.7 k	5	CR37	Carbon
605-606	4822 110 63085	150	5	CR25	Carbon
607	5322 116 50747	1.0 k	1	MR25	Metal film
608	5322 116 54629	14 k	1	MR25	Metal film
609-610	4822 110 63134	10 k	5	CR25	Carbon
611	5322 116 51052	42.2	1	MR25	Metal film
612-613	5322 116 50492	46.4	1	MR25	Metal film

<i>Item</i>	<i>Ordering number</i>	<i>Ohm</i>	<i>Tol. (%)</i>	<i>Type</i>	<i>Remarks</i>
614	5322 116 51052	42.2	1	MR25	Metal film
615-616	4822 110 63054	10	5	CR25	Carbon
617-618	5322 116 54515	348	1	MR25	Metal film
619	5322 116 54549	1.0 k	1	MR25	Metal film
620	5322 116 54608	7.5 k	1	MR25	Metal film
621	5322 116 54549	1.0 k	1	MR25	Metal film
623	4822 110 63063	22	5	CR25	Carbon
624	5322 101 14049	470	20	0.5 W	Carbon potentiometer
625	4822 110 63063	22	5	CR25	Carbon
626	5322 101 14049	470	20	0.5 W	Carbon potentiometer
627	5322 116 54012	6.81 k	1	MR25	Metal film
628-629	4822 110 63063	22	5	CR25	Carbon
630	5322 116 50452	10	1	MR25	Metal film
631	4822 112 21063	22	10	WR0617	Wire-wound
632-633	5322 116 50838	11.5	1	MR25	Metal film
634-635					
636-637	5322 116 64004	24	5	4 W	Metal oxide
638	5322 116 50452	10	1	MR25	Metal film
639	4822 112 21063	22	10	WR0617	Wire-wound
640	5322 116 50479	15.4 k	1	MR25	Metal film
641	5322 116 54725	196 k	1	MR25	Metal film
642-643	5322 116 54696	100 k	1	MR25	Metal film
644	5322 116 54728	215 k	1	MR25	Metal film
645	4822 110 63112	1.5 k	5	CR25	Carbon
646	4822 110 63087	180	5	CR25	Carbon
647	5322 116 54558	8.25 k	1	MR25	Metal film

<i>Item</i>	<i>Ordering number</i>	<i>Henry</i>
Coils		
751	5322 158 10275	3.3 μ

3.5.2.8. Power supply U7

<i>Item</i>	<i>Ordering number</i>	<i>Type/Description</i>
Transistors		
301	5322 130 44462	BC556A
302	4822 130 41067	BC546A
305	5322 130 44034	BSX46-10
321	4822 130 41067	BC546A
322	5322 130 44462	BC556A
325	5322 130 40468	2N2905A
Integrated circuits		
351-352	5322 209 84342	TBA221
Diodes		
401	5322 130 30414	BY164
402	5322 130 34047	BZX75-C1V4
412	5322 130 34397	BZX92
421	5322 130 30414	BY164
422	5322 130 34047	BZX75-C1V4
432	5322 130 34397	BZX92

<i>Item</i>	<i>Ordering number</i>	<i>Farad</i>	<i>Tol. (%)</i>	<i>Volts</i>	<i>Remarks</i>
Capacitors					
501	4822 121 40232	220 n	20	100	Polyester foil
502	5322 124 24067	1000 μ		63	Electrolytic
506	4822 122 31175	1.0 n	-20/+50	400	Ceramic plate
508	4822 124 20374	47 μ		40	Electrolytic
509	4822 122 30103	22 n	-20/+100	40	Ceramic plate
521	4822 121 40232	220 n	20	100	Polyester foil
522	5322 124 24067	1000 μ		63	Electrolytic
526	4822 122 31175	1.0 n	-20/+50	400	Ceramic plate
528	4822 124 20374	47 μ		40	Electrolytic
529	4822 122 30103	22 n	-20/+100	40	Ceramic plate

<i>Item</i>	<i>Ordering number</i>	<i>Ohm</i>	<i>Tol. (%)</i>	<i>Type</i>	<i>Remarks</i>
Resistors					
601	4822 110 63141	18 k	5	CR25	Carbon
602	4822 110 63092	270	5	CR25	Carbon
603	5322 113 60103	0,82	5	0.5 W	Wire-wound
605	4822 110 63129	6.8 k	5	CR25	Carbon
606	4822 110 63127	5.6 k	5	CR25	Carbon
607	5322 116 50579	3.16 k	1	MR25	Metal film
608	5322 116 54889	22.6 k	0.1	0.4 W	Metal film
609	5322 116 54165	6.81 k	0.1	0.4 W	Metal film
621	4822 110 63141	18 k	5	CR25	Carbon
622	4822 110 63092	270	5	CR25	Carbon
623	5322 113 60103	0,82	5	0.5 W	Wire-wound
625	4822 110 63129	6.8 k	5	CR25	Carbon
626	4822 110 63127	5.6 k	5	CR25	Carbon
627	5322 116 50579	3.16 k	1	MR25	Metal film
628	5322 116 54889	22.6 k	0.1	0.4 W	Metal film
629	5322 116 54165	6.81 k	0.1	0.4 W	Metal film

3.5.3. Miscellaneous

<i>Item</i>	<i>Fig.</i>	<i>Quantity</i>	<i>Order number</i>	<i>Description</i>
52	14	1	5322 216 64125	Printed-wiring board unit 1
53	14	1	5322 216 64187	Printed-wiring board unit 2
54	14	1	5322 216 64188	Printed-wiring board unit 3
55	14	1	5322 216 64189	Printed-wiring board unit 4
56	14	1	5322 216 64191	Printed-wiring board unit 5
57	14	1	5322 216 64192	Printed-wiring board unit 6
58	14	1	5322 216 64193	Printed-wiring board unit 7
59	14	1	4822 253 30014	Fuse, 315 mA, 250 V
60	14	1	4822 253 30018	Fuse, 630 mA, 250 V
61	14	1	5322 146 34047	Mains transformer
62	14	1	5322 321 14001	Mains cable
63	12	1	5322 134 44112	Indication lamp "Power ON"
64	12	1	5322 134 44113	Indication lamp "Overrange"

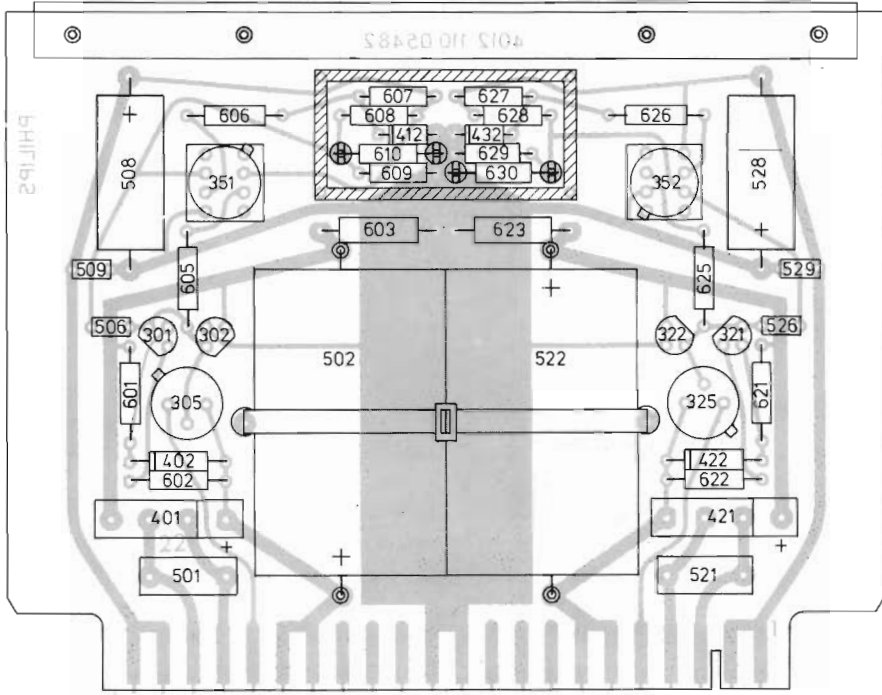

Fig. 16. Printed-wiring board U7.

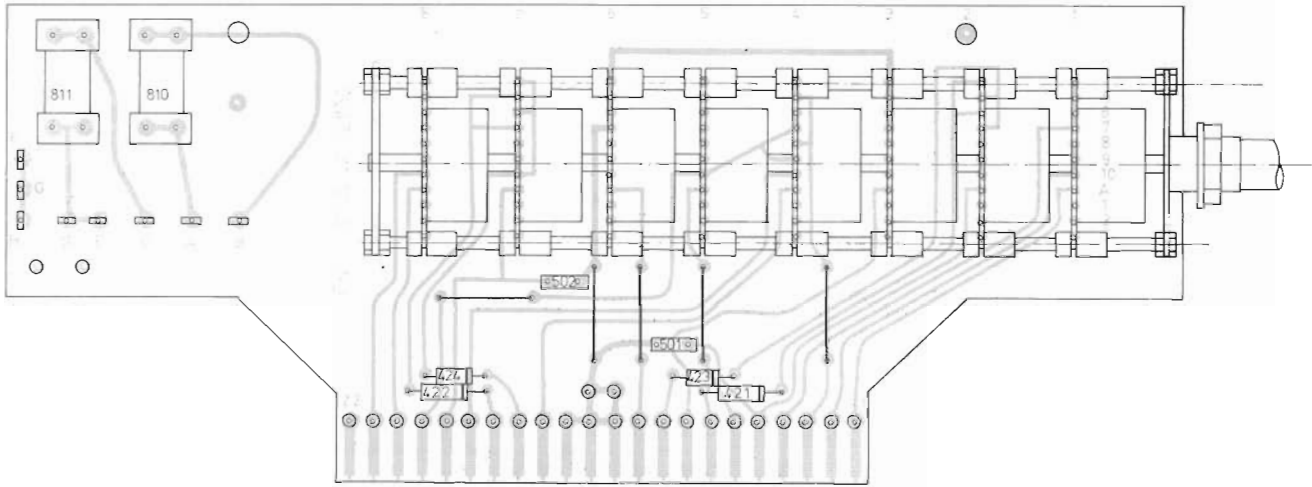

Fig. 18 Printed-wiring board U1.

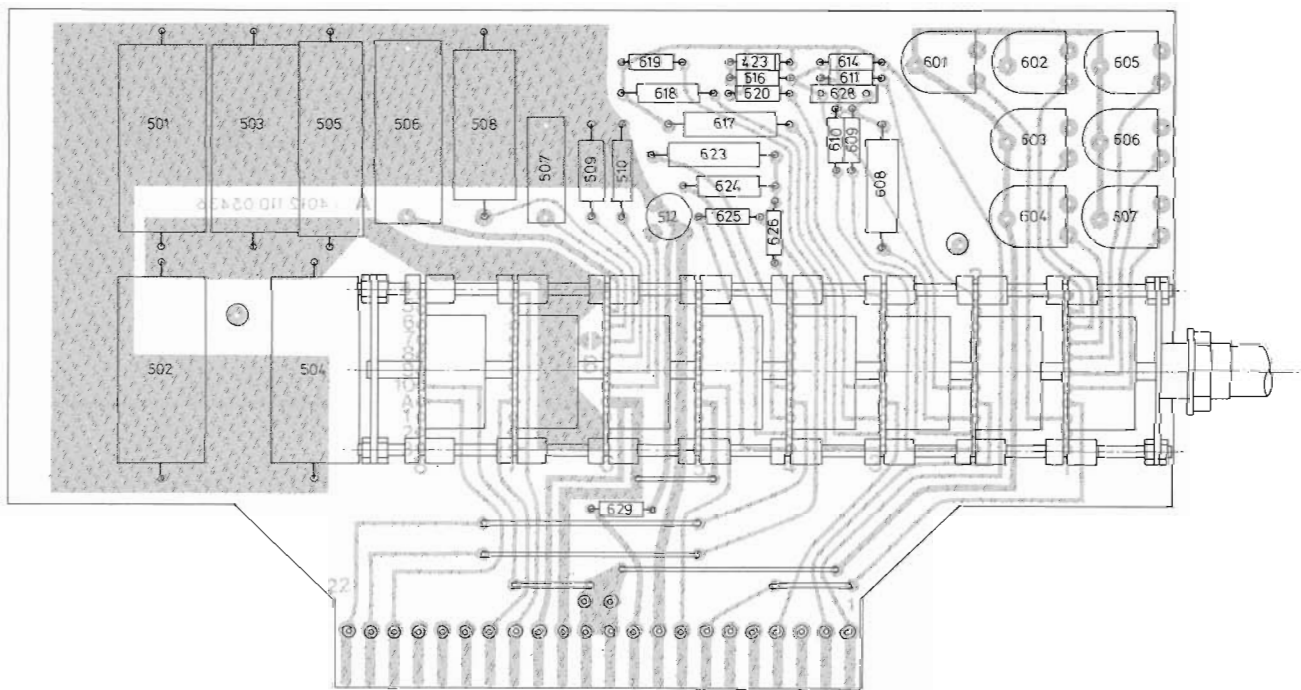

Fig. 19 Printed-wiring board U2.

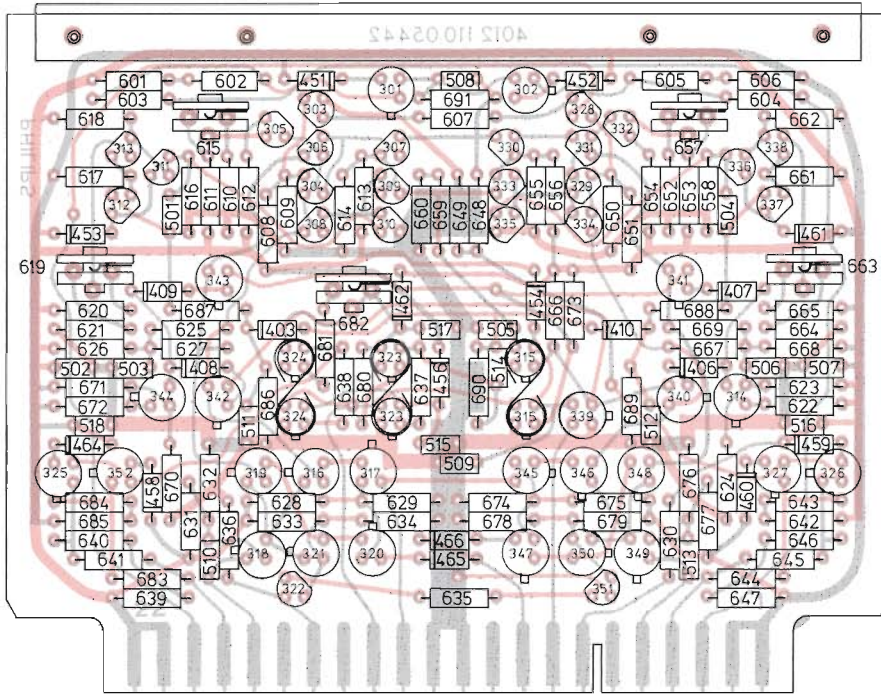

Fig. 20. Printed-wiring board U3

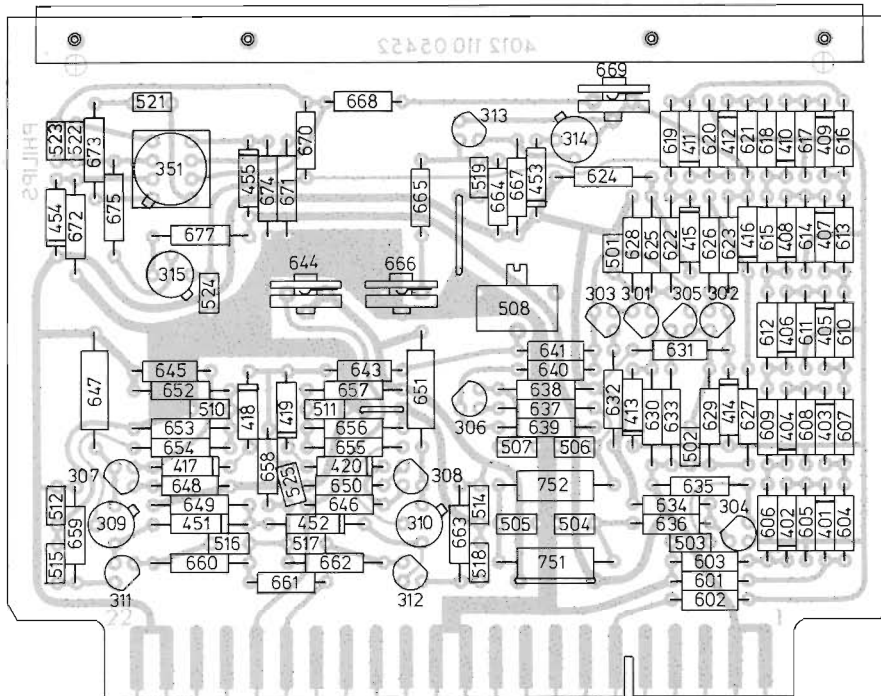

Fig. 21. Printed-wiring board U4.

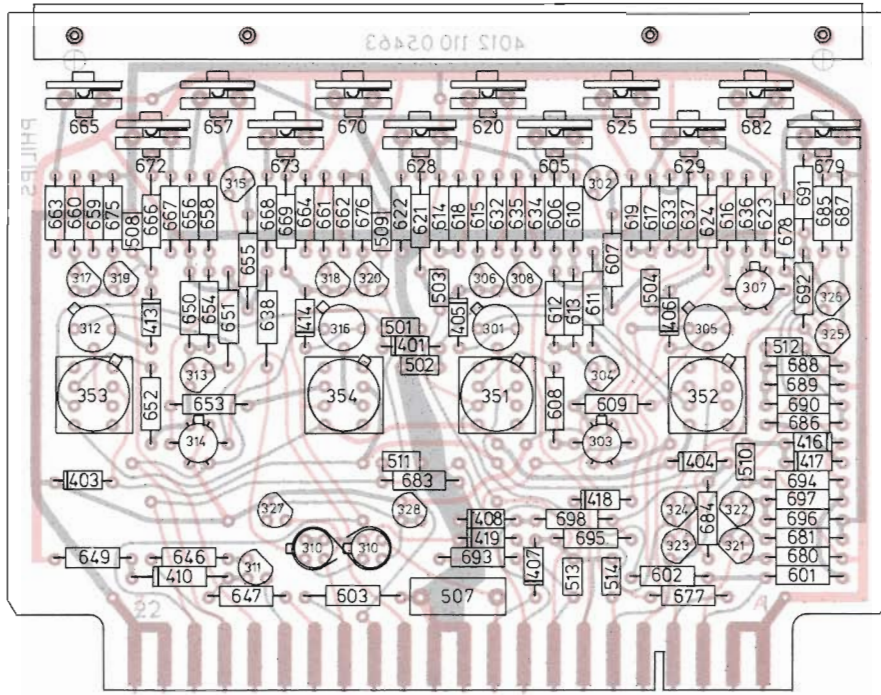

Fig.22. Printed-wiring board U5

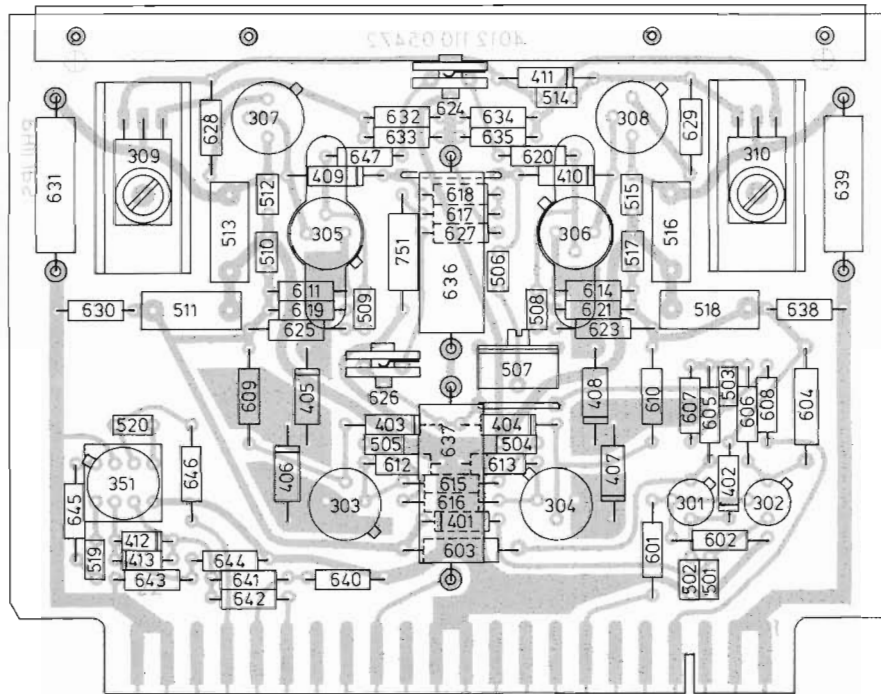

Fig. 23: Printed-wiring board U6

3.3.1. GENERAL CHECK

Seq.	SETTING															MEASURING			ADJUSTMENT	
	Knobs							Switches					Sockets			Measuring point	Measured value	Explanation	Position nr.	UNIT
	WAVE-FORM (802)	FREQ. Hz (601)	FREQ. MULTI. (803)	FREQ. OFFSET (602)	DC OFFSET (603)	AMPLI-TUDE (604)	SET PHASE (605)	DC OFFSET (804)	0 dB -20 dB (805)	SINGLE SHOT (806)	RUN HOLD (807)	SWEEP IN (815)	SQUARE OUT (816)	OUT-PUT (817)	CONTR INPUT (818)					
1.																	Connect the instrument to the mains - Button POWER to ON Lamp POWER must light			
1.1		10	100				0		OFF	RUN	L	Q		L		SQUARE OUT	$U_{pp} = (1 \pm 0,1) V$	$U_{pp} = U_{\text{signal}}$		
1.2	X	10	1			20 V _{pp}	} 0		OFF	RUN	L	Q		L		OUTPUT	Waveform X	X = all positions of WAVEFORM-selector: 		
1.3	X	10	10			20 V _{pp}														
1.4	X	10	100			20 V _{pp}														
1.5	X	10	1k			20 V _{pp}														
1.6	X	10	10k			20 V _{pp}														
1.7	X	10	100k			20 V _{pp}														
1.8	X	10	1M			20 V _{pp}	0		OFF	RUN	L		Q		OUTPUT	Waveform X	X = WAVEFORM:			
1.9		10	X			20 V _{pp}	0		OFF	RUN	L	Z	Q	L		SQUARE OUT	f = 10.X Hz	X = 1, 10, 100, 1k, 10k, 100k, 1M		
1.10		X	100			20 V _{pp}	0		OFF	RUN	L	Z	Q	L		SQUARE OUT	f = X . 100 Hz	X = 1, 2, 3, 4 ... 10		
1.11		10	100	±5 %		20 V _{pp}	0		OFF	RUN	L	Z	Q	L		SQUARE OUT	$\Delta f = \pm 5 \%$			
1.12		10	100	0		20 V _{pp}	0		OFF	RUN	X	Z	Q			SQUARE OUT	$\Delta f \leq +50 \%$ f = 0	for X = +12 V } input voltage for X = -12 V }		
1.13		10	100		X	0		+DC	0 dB	OFF	RUN	L		Q	L		OUTPUT	U = continuous variation	X = DC-offset 0 ... 10 V	
1.14		10	100		10 V	0		+DC/-DC	0 dB	OFF	RUN	L		Q	L		OUTPUT	$\Delta U = (10 \pm 2) V$		
1.15		10	100			X		0	0 dB	OFF	RUN	L		Q	L		OUTPUT	$A = \frac{1}{2} \pm 10 \%$	X = Amplitude 20 V _{pp} , 30 V _{pp} , 40 V _{pp}	
1.16		10	100		10 V	X		+DC	0 dB	OFF	RUN	L		Q	L			OVERRRANGE lamp lights at X > 20 V _{pp}		
1.17		10	100		10 V	X		-DC	0 dB	OFF	RUN	L		Q	L			OVERRRANGE lamp lights at X > 20 V _{pp}		
1.18.1 or 1.18.2		10	100			20 V _{pp}	0	0/-20	OFF	RUN	L			Q	L		OUTPUT	$\Delta A = - (20 \pm 0,5) dB$	$\Delta A = \text{Amplitude difference } 0 dB / -20 dB$	
														AC-V				$U_0 = 5.00 V \quad U_{-20 dB} = (500 \pm 30) mV_{rms}$		
1.19		10	0.1			20 V _{pp}	-	0		SET PH. /START	RUN	L		Q	L		OUTPUT	$U_{START} = U_X + 1\% / -0 \%$	$U_X = \text{potential of the neg. triangle peak value}$	
1.20		10	0.1			20 V _{pp}	+	0		SET PH. /START	RUN	L		Q	L		OUTPUT	$U_{START} = U_X - 1\% / +0\%$	$U_X = \text{potential of the pos. triangle peak value}$	
1.21		10	0.1			20 V _{pp}	0	0		START	RUN	L		Q	L		OUTPUT	u (t) = 1 Period	u(t) = voltage-time function	
1.22		10	0.1			20 V _{pp}		0		OFF	X	L		Q	L		OUTPUT	u (t) $\hat{=}$ RUN/HOLD	X = Switching over RUN-HOLD at the negative-going edge of the -signal	
1.23		10	0.1			20 V _{pp}		0		OFF	X	L		Q	L		OUTPUT	u (t) $\hat{=}$ RUN/HOLD	X = Switching over RUN-HOLD at the positive-going edge of the -signal	
1.24		10	0.1			40 V _{pp}		0	0 dB	OFF	HOLD	L		V	L		OUTPUT	$\frac{\Delta U}{\Delta t} \leq 15 \frac{mV}{min}$	Switch 807 to HOLD, first wait 5 minutes, then measure the voltage drift during 1 min.	
1.25		10	0.1			20 V _{pp}		0		OFF	RUN	L		Q	U _S		OUTPUT	u(t) at U _S = 0 V $\hat{=}$ u(t) in position RUN without control voltage u(t) at U _S = +5 V $\hat{=}$ u(t) in position HOLD without control voltage		
1.26		10	0.1			20 V _{pp}	0	0		SET PHASE	RUN	L		Q	X		OUTPUT	u(t) = 1 Period	X = negative going pulse from 0 to -5 V at $\Delta t < 1 \mu s$	

3.3.2. ADJUSTMENT

Seq.	SETTING														MEASURING			ADJUSTMENT				
	Knobs							Switches				Sockets			Measuring point	Measured value	Explanation	Position nr.	UNIT			
	WAVE-FORM	FREQ. HZ	FREQ. MULTI.	FREQ. OFFSET	DC OFFSET	AMPLI-TUDE	SET PHASE	DC OFFSET	0 dB -20 dB	SINGLE SHOT	RUN HOLD	SWEEP IN	SQUARE OUT	OUT-PUT						CONTR. INPUT		
(802)	(601)	(803)	(602)	(603)	(604)	(605)	(804)	(805)	(806)	(807)	(815)	(816)	(817)	(818)								
2.	Disconnect mains plug - Open soldering-joint A, close soldering-joint B on UNIT 2 - Warm up the instrument with closed housing																					
2.1		10	0.1	0		20 V _{pp}		0	0	OFF	RUN	L		Q	L	22/UNIT 7	U = + (30 ± 0,09) V	+30 V = -30 V	610	7		
2.2		10	0.1	0		20 V _{pp}		0	0	OFF	RUN	L		Q	L	1/UNIT 7	U = - (30 ± 0,09) V		V	630	7	
2.3		10	0.1	0		20 V _{pp}		0	0	OFF	RUN	L		Q	L	22 and 1/UNIT 7	U < 1mVrms	ripple voltage	Q	-	-	
2.4		0,1	1 m	0		20 V _{pp}		0	0	OFF	RUN	L		Q	L	3/UNIT 3	U ₊ = + (5 ± 0,005) V	pos. \square amplitude	V	615	3	
2.5		0,1	1 m	0		20 V _{pp}		0	0	OFF	RUN	L		Q	L	3/UNIT 3	U ₋ = - (5 ± 0,005) V	neg. \square amplitude	V	657	3	
2.6		10	0,1	0		20 V _{pp}		0	0	OFF	RUN	L		Q	L	19/UNIT 3	U = 0 ± 5 mV	\sim -DC-offset	V	682	3	
2.7		10	0,1	0		20 V _{pp}		0	0	OFF	RUN	L		V	L	OUTPUT	U = 0 ± 10 mV	V	624	6		
2.8		10	0,1	0		20 V _{pp}		0	0	OFF	RUN	L		K	L	OUTPUT	K < 0,2 %	If necessary, adjust K alternately to minimum; observe on an oscilloscope the harmonic content at the output of the distortiometer and clipp the peaks when adjusting	666	4		
2.9		10	0,1	0		20 V _{pp}		0	0	OFF	RUN	L		Q	L	17/UNIT 4	U = 0 ± 5 mV		\sim -DC-offset	V	669	4
2.10		10	0,1	0		20 V _{pp}		0	0	OFF	RUN	L		Q	L	17/UNIT 4	U = 0 ± 5 mV	\sim -DC-offset	V	644	4	
2.11		10	0,1	0		20 V _{pp}		0	0	SET PHASE	RUN	L		Q	G	OUTPUT	U _{START} = U _V + 1 % / -0 %	U _V = potential of the neg. triangular peak value	V	679	5	
2.12		10	0,1	0		20 V _{pp}	+	0	0	SET PHASE	RUN	L		Q	G	OUTPUT	U _{START} = U _X - 1 % / +0 %	U _X = pot. of the pos. triangular peak value to adjust alternately with nr. 2.11.	V	682	5	
2.13		.01	1	0		20 V _{pp}		0	0	OFF	RUN	L		Q	L	D-K/UNIT 5	U _{D-K} = - (10 ± 0,4) mV	D = Low, K = High	V	605	5	
2.14		.01	1	0		20 V _{pp}		0	0	OFF	RUN	L		Q	L	P-W/UNIT 5	U _{P-W} = - (10 ± 0,4) mV	P = Low, W = High	V	657	5	
2.15		1	10 m			20 V _{pp}		0	0	OFF	RUN	L	Z	Q	L	SQUARE OUT	T = 100 T ₁ ± 3 %	T ₁ = Pulse duration at FREQ. MULTI. to 1	V	665	5	
2.16		1	1 m			20 V _{pp}		0	0	OFF	RUN	L	Z	Q	L	SQUARE OUT	T = 1000 T ₁ ± 3 %	(T ₁ ≈ 100 μs/neg. pulse)	V	672	5	
2.17		1	0.1			20 V _{pp}		0	0	OFF	RUN	L	Z	Q	L	SQUARE OUT	T = 10 T ₁ ± 3 %	Repeat alternately the adjustment	V	-	-	
2.18		1	10 m			20 V _{pp}		0	0	OFF	RUN	L	Z	Q	L	SQUARE OUT	T = 100 T ₁ ± 3 %	T ₁ = Pulse duration at FREQ. MULTI. to 1	V	670	5	
2.19		1	1 m			20 V _{pp}		0	0	OFF	RUN	L	Z	Q	L	SQUARE OUT	T = 1000 T ₁ ± 3 %	(T ₁ ≈ 100 μs/pos. pulse)	V	673	5	
2.20		1	0.1			20 V _{pp}		0	0	OFF	RUN	L	Z	Q	L	SQUARE OUT	T = 10 T ₁ ± 3 %	Repeat alternately the adjustment	V	-	-	
2.21		1	10 m			20 V _{pp}		0	0	OFF	RUN	L	Z	Q	L	SQUARE OUT	T = 100 T ₁ ± 1 %	T ₁ = period time at FREQ. MULTI. to 1	V	625	5	
2.22		1	1 m			20 V _{pp}		0	0	OFF	RUN	L	Z	Q	L	SQUARE OUT	T = 1000 T ₁ ± 1 %	(T ₁ ≈ 1 ms)	V	629	5	
2.23		1	0.1			20 V _{pp}		0	0	OFF	RUN	L	Z	Q	L	SQUARE OUT	T = 10 T ₁ ± 1 %	Repeat alternately the adjustment	V	-	-	
2.24		1	10 m			20 V _{pp}		0	0	OFF	RUN	L	Z	Q	L	SQUARE OUT	T = 100 T ₁ ± 2 %	T ₁ = period time at FREQ. MULTI. to 1	V	620	5	
2.25		1	1 m			20 V _{pp}		0	0	OFF	RUN	L	Z	Q	L	SQUARE OUT	T = 1000 T ₁ ± 2 %	(T ₁ ≈ 1 ms)	V	628	5	
2.26		1	0.1			20 V _{pp}		0	0	OFF	RUN	L	Z	Q	L	SQUARE OUT	T = 10 T ₁ ± 2 %	Repeat alternately the adjustment	V	-	5	
2.27	Disconnect mains plug - Close soldering-joint A, open soldering-joint B (original state) on UNIT 2 - Warm up the instrument with closed housing																					
2.28		10	10k	0		20 V _{pp}		0	0	OFF	RUN	L		K	L	OUTPUT	K < 0,6 %	Terminate measuring cable at distortiometer with 50 Ω. Repeat alternately the adjustment	619	3		
2.29		10	10k	0		20 V _{pp}		0	0	OFF	RUN	L		50 Ω	L	OUTPUT	K < 0,6 %		V	663	3	
2.30		10,0	1	0		40 V _{pp}		0	0	OFF	RUN	L	Z	Q	L	SQUARE OUT	T = (100 ± 0,3) ms		V	601	2	
2.31		1	1	0		40 V _{pp}		0	0	OFF	RUN	L	Z	Q	L	SQUARE OUT	T = 10 T ₁ ± 2 %	T ₁ = Period time at FREQ Hz to 10, if necessary, adjust potentiometer shaft FREQ Hz after loosening the two internal hexagon bolts	V	potentiometer shaft FREQ Hz		
2.32		10,0	10	0		40 V _{pp}		0	0	OFF	RUN	L	Z	Q	L	SQUARE OUT	T = (10 ± 0,03) ms		V	602	2	
2.33		10,0	100	0		40 V _{pp}		0	0	OFF	RUN	L	Z	Q	L	SQUARE OUT	T = (1 ± 0,003) ms		V	603	2	
2.34		X	100	0		40 V _{pp}		0	0	OFF	RUN	L	Z	Q	L	SQUARE OUT	f = X · 100 Hz ± 1 %	X = 1, 2 ... 10	± 0,2 % of end of scale value	V	603	2
2.35		10,0	1 k	0		40 V _{pp}		0	0	OFF	RUN	L	Z	Q	L	SQUARE OUT	f = (10 ± 0,03) kHz		V	604	2	
2.36		10,0	10 k	0		40 V _{pp}		0	0	OFF	RUN	L	Z	Q	L	SQUARE OUT	f = (100 ± 2) kHz		V	605	2	
2.37		X	10 k	0		40 V _{pp}		0	0	OFF	RUN	L	Z	Q	L	SQUARE OUT	f = X · 10 kHz ± 1 %	X = 1, 2 ... 10	± 0,2 % of end of scale value	V	605	2
2.38		10,0	100k	0		40 V _{pp}		0	0	OFF	RUN	L	Z	Q	L	SQUARE OUT	f = (1 ± 0,006) MHz		V	606	2	
2.39		X	1M	0		40 V _{pp}		0	0	OFF	RUN	L	Z	Q	L	SQUARE OUT	f = X MHz ± 3,5 %	X = 1, 2, 3, 4 ... 10	Repeat alternately the adjustment	V	607	2
2.40		X	1M	0		40 V _{pp}		0	0	OFF	RUN	L	Z	Q	L	SQUARE OUT	f = X MHz ± 3,5 %			V	512	2
2.41		10	100k	0		32 V _{pp}		0		OFF	RUN	L		Q	L	OUTPUT	Signal form:	Adjust the potential of the peak very accurately to the roof value.	V	507	6	
2.42		10	100-1M	0		32 V _{pp}		0		OFF	RUN	L		Q	L	OUTPUT	ΔA ≤ - 5 % / 0 %	ΔA = $\sqrt{\text{Amplitude response}}$; if necessary repeat alternately adjustments 2.41 and 2.42.	V	507	6	
2.43		1,2...10	1M	0		32 V _{pp}		0		OFF	RUN	L		Q	L	OUTPUT	\sim -ampl. response ΔA to min.	ΔA = max. amplitude - min. amplitude in range 1 to 10 MHz	V	508	4	
2.44		10	100			40 V _{pp}		0	0	OFF	RUN	L		AC-V	L	OUTPUT	U _{eff} = (14,2 ^{+0,142} ₋₀) V		V	626	6	
2.45		10	1M	0		40 V _{pp}		0	0	OFF	RUN	L		K	L	OUTPUT	K < 4,7 % (27 dB)		V	-	-	

3.3.3. CHECKING

Seq.	SETTING																MEASURING			ADJUSTMENT	
	Knobs							Switches					Sockets				Measuring point	Measured value	Explanation	Position nr.	UNIT
	WAVE-FORM (802)	FREQ. Hz (601)	FREQ. MULTI. (803)	FREQ. OFFSET (602)	DC OFFSET (603)	AMPLI-TUDE (604)	SET PHASE (605)	DC OFFSET (804)	0 dB -20 dB (805)	SINGLE SHOT (806)	RUN HOLD (807)	SWEEP IN (815)	SQUARE OUT (816)	OUT-PUT (817)	CONTR. INPUT (818)						
3.1		X	1M	0	0	40 V _{pp}		0	0	OFF	RUN	L	Z		L	SQUARE OUT	f = X MHz ± 3,5 %	X = 1, 2, 3, 4 ... 10			
3.2		10	100k	0		40 V _{pp}		0	0	OFF	RUN	L	Z	Q	L	SQUARE OUT	f = (1 ± 0,01) MHz				
3.3		X	10k	0		40 V _{pp}		0	0	OFF	RUN	L	Z	Q	L	SQUARE OUT	f = X · 10 kHz ± 1 % ± 0,2 % of end of scale value	X = 1, 2 ... 10			
3.4		10	1k	0		40 V _{pp}		0	0	OFF	RUN	L	Z	Q	L	SQUARE OUT	f = (10 ± 0,1) kHz				
3.5		10	100	0		40 V _{pp}		0	0	OFF	RUN	L	Z	Q	L	SQUARE OUT	T = (1 ± 0,01) ms				
3.6		10	10	0		40 V _{pp}		0	0	OFF	RUN	L	Z	Q	L	SQUARE OUT	T = (10 ± 0,1) ms				
3.7		10	1	0		40 V _{pp}		0	0	OFF	RUN	L	Z	Q	L	SQUARE OUT	T = (100 ± 1) ms				
3.8		10	0,1	0	0	40 V _{pp}		0	0	OFF	RUN	L	Z		L	SQUARE OUT	T = (1 ± 0,02) s				
3.9		10	0,1	0	0	40 V _{pp}		0	0	OFF	RUN	L	Z		L	SQUARE OUT	T = (1 ± 0,02) s				
3.10		10	0,1	0	0	40 V _{pp}		0	0	OFF	RUN	L	Z		L	SQUARE OUT	T = (1 ± 0,02) s				
3.11		10	10m	0		40 V _{pp}		0	0	OFF	RUN	L	Z		L	SQUARE OUT	T = (10 ± 0,4) s				
3.12		10	10m	0		40 V _{pp}		0	0	OFF	RUN	L	Z		L	SQUARE OUT	T = (10 ± 0,4) s				
3.13		10	10m	0		40 V _{pp}		0	0	OFF	RUN	L	Z		L	SQUARE OUT	T = (10 ± 0,4) s				
3.14		10	1m	0		40 V _{pp}		0	0	OFF	RUN	L	Z		L	SQUARE OUT	T = (100 ± 4) s				
3.15		10	1m	0		40 V _{pp}		0	0	OFF	RUN	L	Z		L	SQUARE OUT	T = (100 ± 5) s				
3.16		10	1m	0		40 V _{pp}		0	0	OFF	RUN	L	Z		L	SQUARE OUT	T = (100 ± 5) s				
3.17		10	10k	0		32 V _{pp}		0	0	OFF	RUN	L		Q	L	OUTPUT	ΔA < 2 %	ΔA = Amplitude response Ref. value: amplitude at 1 kHz			
3.18		10	10k	0		32 V _{pp}		0	0	OFF	RUN	L		Q	L	OUTPUT	ΔA < 4 %				
3.19		10	10k	0		32 V _{pp}		0	0	OFF	RUN	L		Q	L	OUTPUT	ΔA < 4 %				
3.20		10	10k	0		32 V _{pp}		0	0	OFF	RUN	L		Q	L	OUTPUT	ΔA < 4 %				
3.21		10	100k	0		32 V _{pp}		0	0	OFF	RUN	L		Q	L	OUTPUT	ΔA < 2 %				
3.22		10	100k	0		32 V _{pp}		0	0	OFF	RUN	L		Q	L	OUTPUT	ΔA < 7 %				
3.23		10	100k	0		32 V _{pp}		0	0	OFF	RUN	L		Q	L	OUTPUT	ΔA < 7 %				
3.24		10	100k	0		32 V _{pp}		0	0	OFF	RUN	L		Q	L	OUTPUT	ΔA < 7 %				
3.25		X	1M	0		32 V _{pp}		0	0	OFF	RUN	L		Q	L	OUTPUT	ΔA < 7 %				
3.26		10	10k	0		40 V _{pp}		0	0	OFF	RUN	L		K 50 Ω	L	OUTPUT	K < 0,85 %				
3.27		10	100k	0		40 V _{pp}		0	0	OFF	RUN	L		Q	L	OUTPUT	t _A < 20 ns	t _A = rise time			
3.28		10	100k	0		40 V _{pp}				OFF	RUN	L	Q		L	SQUARE OUT	t _A < 18 ns	t _A = rise time			
3.29		4	1M	0		40 V _{pp}		0	0	OFF	RUN	L		Q	L	OUTPUT	w < 7 %	w = ripple and overshoot with respect to peak-to-peak			
3.30		10	100			0		0	0	OFF	RUN	L		AC-V	L	OUTPUT	α = (30 ± 3) dB	Attenuation α with respect to 40 V _{pp}			
3.31		1,2...10	10			40 V _{pp}		0	0	OFF	RUN	L		Q 1 nF	L	OUTPUT	Stability	no instability			

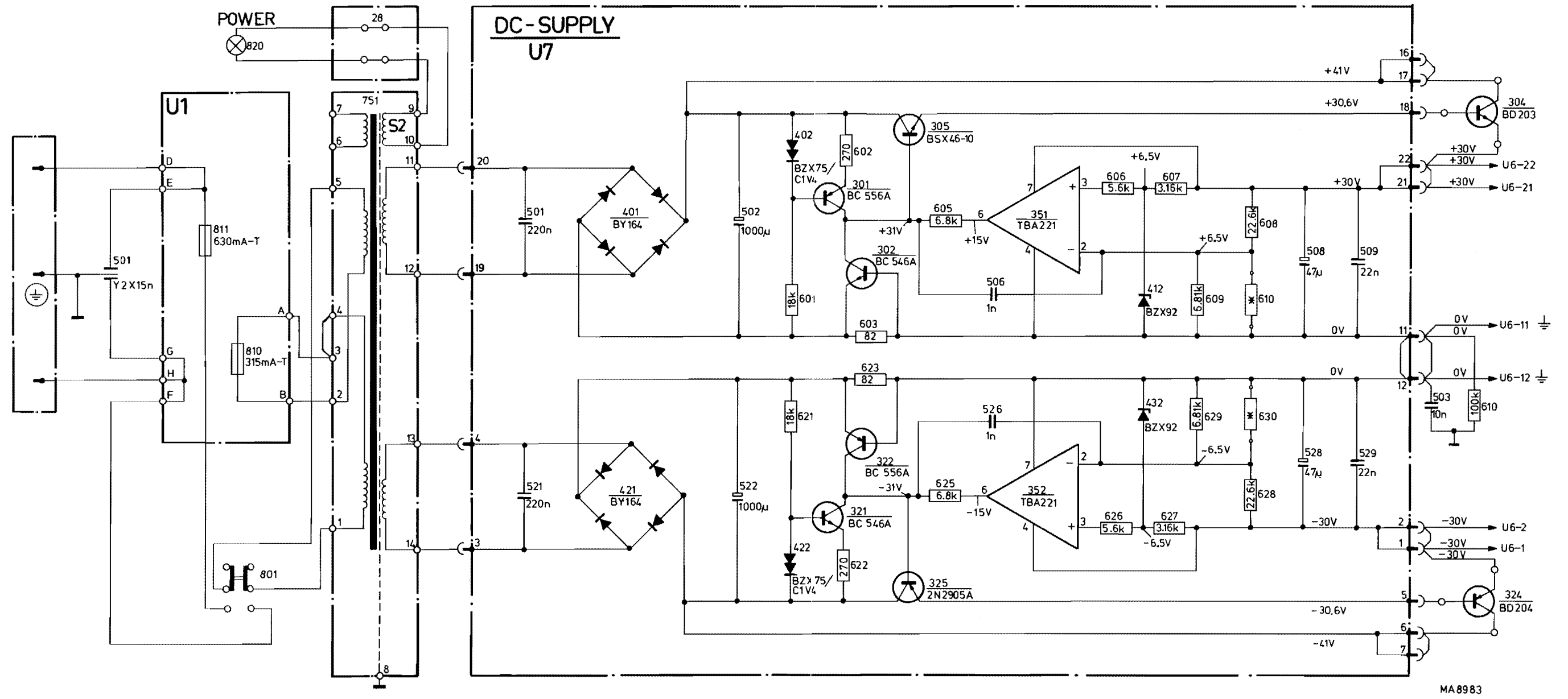

MA8983

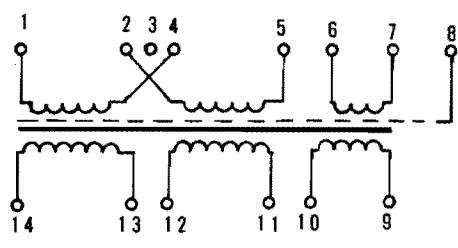
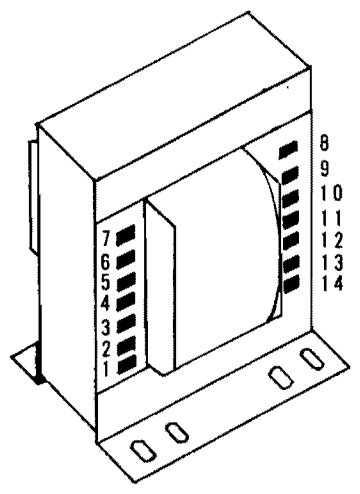

CONNECTIONS	1-4	2-5	6-7	9-10	11-12	13-14
URNS	675	675	110	34	222	222
VOLTAGE	110V	110V	18V	5.2V	33V	33V
CURRENT	0.28A	0.28A	0.28A	0.04A	0.9A	0.9A
∅	0.315	0.315	0.315	0.315	0.56	0.56

Fig. 17. Circuit diagram of the power supply U7

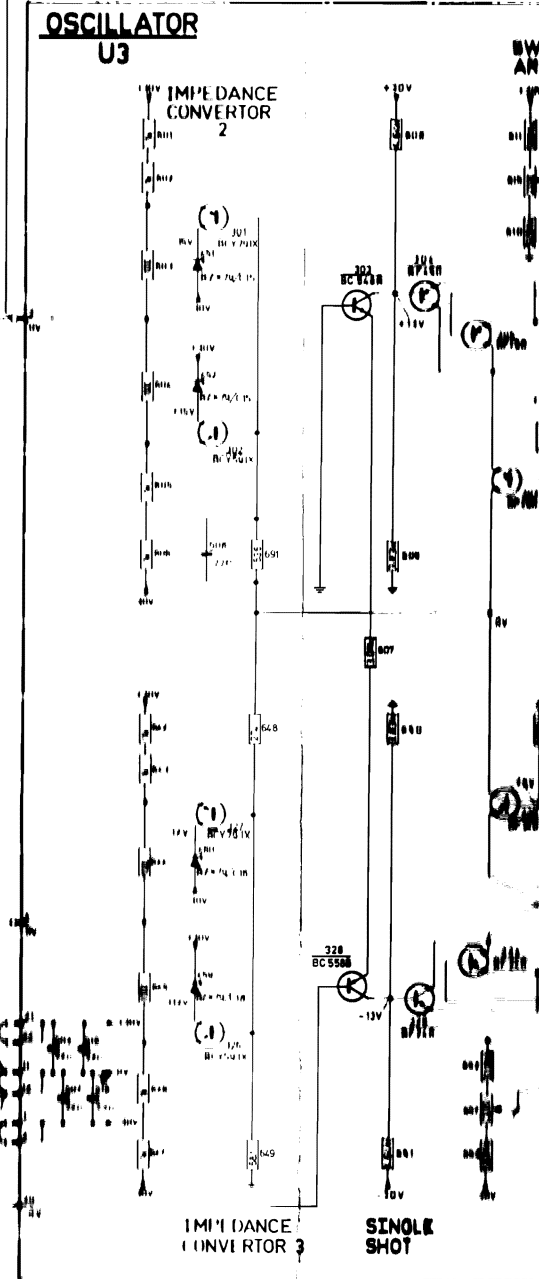
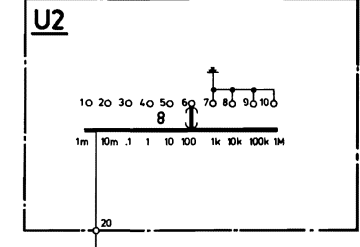
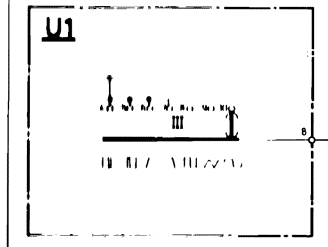
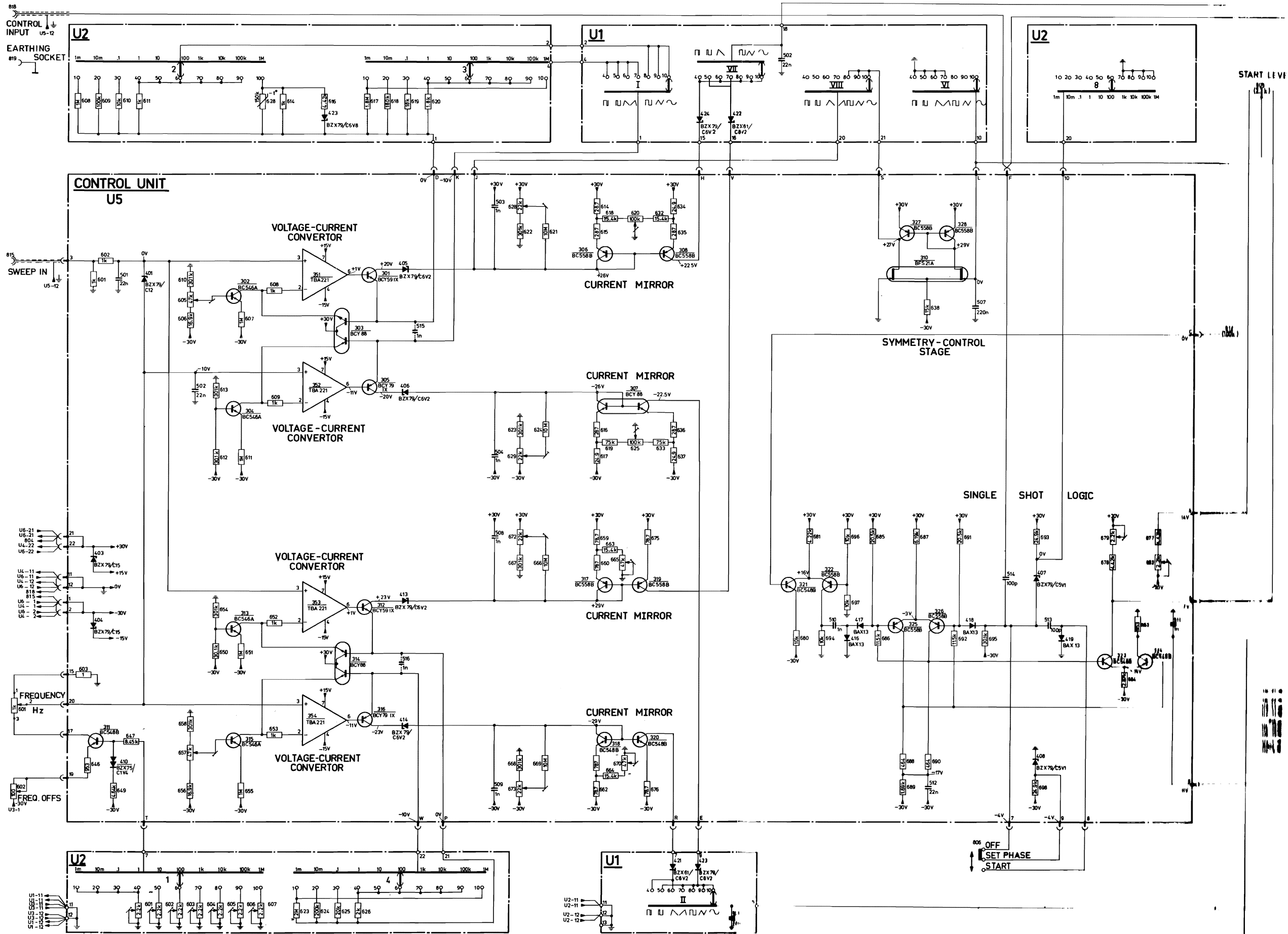

In version -/05 resistor 629/U2 is mounted as resistor 611 (22 Ω) between connections 10/U1 and 10/U2.

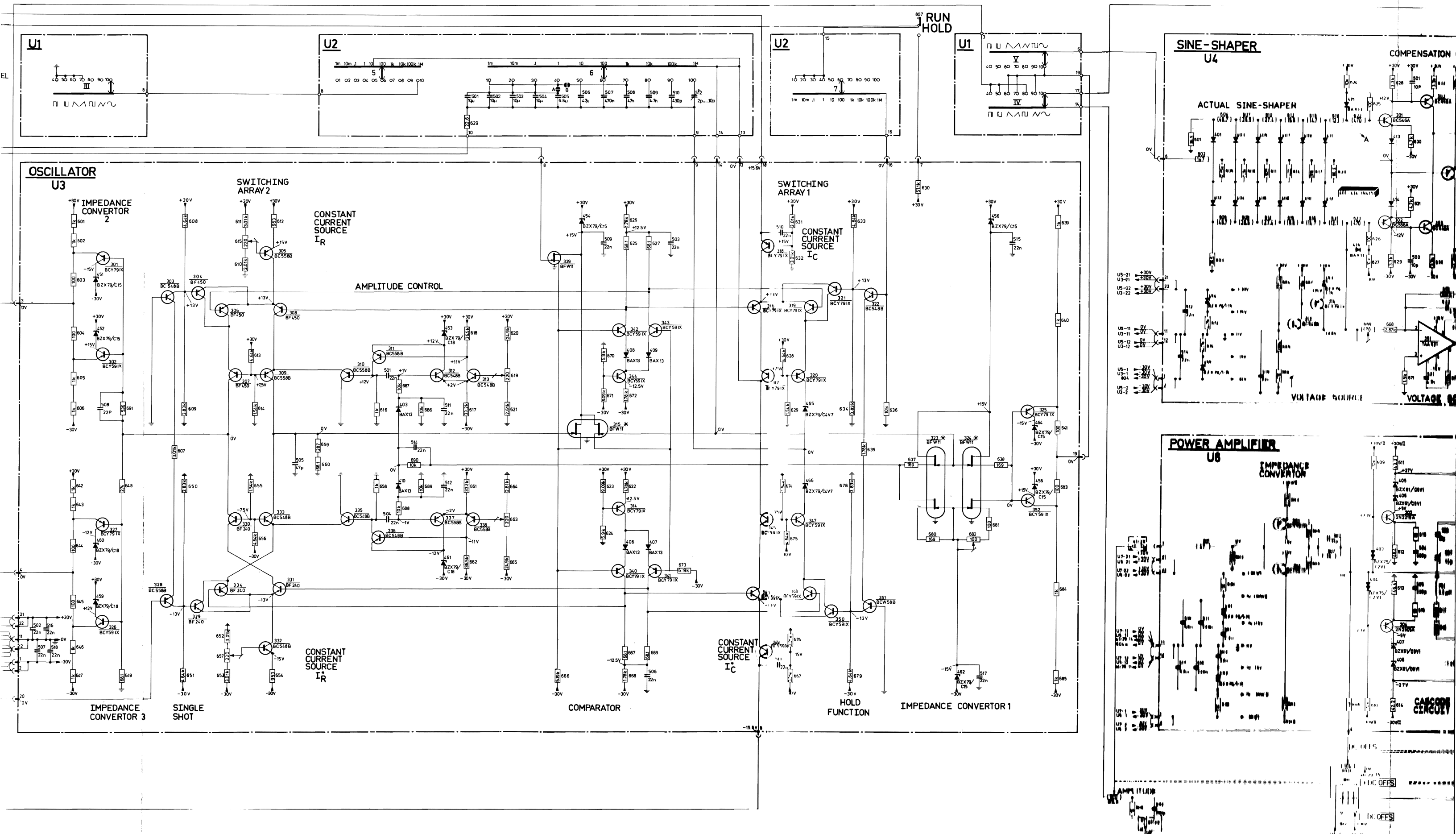

connections 10/U1 and 10/U2.

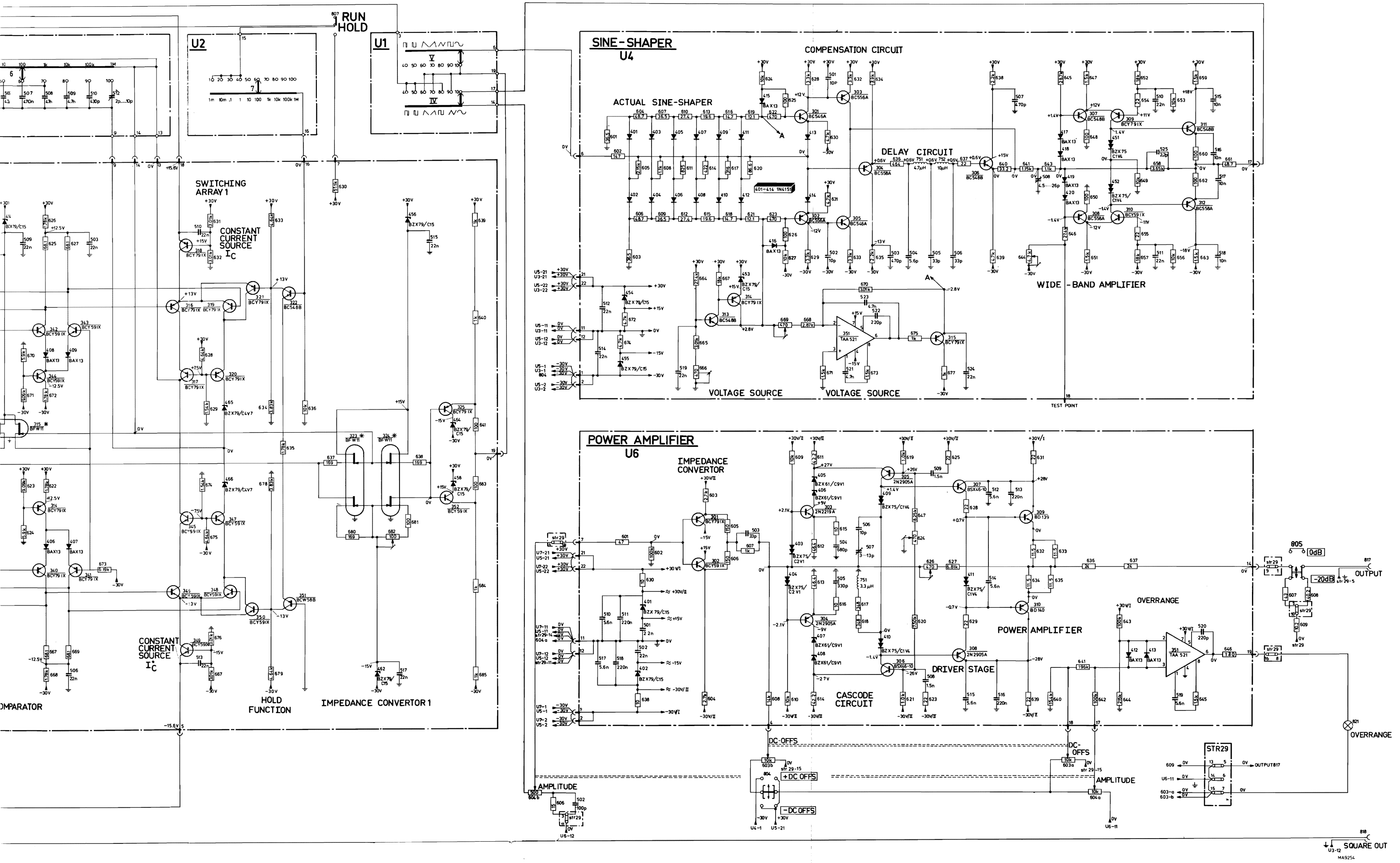

Fig. 24. Overall circuit diagram PM 5167/05.

QUALITY REPORTING

CODING SYSTEM FOR FAILURE DESCRIPTION

The following information is meant for Philips service workshops only and serves as a guide for exact reporting of service repairs and maintenance routines on the workshop charts.

For full details reference is made to Information G1 (Introduction) and Information Cd 689 (Specific information for Test and Measuring Instruments).

LOCATION

Unit number

e.g. 000A or 0001 (for unit A or 1; **not 00UA or 00U1**)

or: Type number of an accessory (only if delivered with the equipment)

e.g. 9051 or 9532 (for PM 9051 or PM 9532)

or: Unknown/Not applicable
0000

COMPONENT/SEQUENCE NUMBER

Enter the identification as used in the circuit diagram, e.g.:

GR1003	Diode GR1003
TS0023	Transistor TS23
IC0101	Integrated circuit IC101
R0....	Resistor, potentiometer
C0....	Capacitor, variable capacitor
B0....	Tube, valve
LA....	Lamp
VL....	Fuse
SK....	Switch
BU....	Connector, socket, terminal
T0....	Transformer
L0....	Coil
X0....	Crystal
CB....	Circuit block
RE....	Relay
BA....	Battery
TR....	Chopper

CATEGORY

- 0 Unknown, not applicable (fault not present, intermittent or disappeared)
- 1 Software error
- 2 Readjustment
- 3 Electrical repair (wiring, solder joint, etc.)
- 4 Mechanical repair (polishing, filing, remachining, etc.)
- 5 Replacement
- 6 Cleaning and/or lubrication
- 7 Operator error
- 8 Missing items (on pre-sale test)
- 9 Environmental requirements are not met

Parts not identified in the circuit diagram:

990000	Unknown/Not applicable
990001	Cabinet or rack (text plate, emblem, grip, rail, graticule, etc.)
990002	Knob (incl. dial knob, cap, etc.)
990003	Probe (only if attached to instrument)
990004	Leads and associated plugs
990005	Holder (valve, transistor, fuse, board, etc.)
990006	Complete unit (p.w. board, h.t. unit, etc.)
990007	Accessory (only those without type number)
990008	Documentation (manual, supplement, etc.)
990009	Foreign object
990099	Miscellaneous

Sales and service all over the world

- Alger:** Sadatel; 41 Rue des Frères Mouloud Alger; tel. 656613-656607
- Argentina:** Philips Argentina S.A., Cassila Correo 3479, Buenos Aires; tel. T.E. 70, 7741 al 7749
- Australia:** Philips Electrical Pty Ltd., Philips House, 69-79 Clarence Street, Box 2703 G.P.O., Sydney; tel. 2.0223
- België/Belgique:** M.B.L.E., Philips Bedrijfs-apparaat, 30 Rue des Deux Gares, Bruxelles; tel. 02/13.76.00
- Bolivia:** Industrias Bolivianas Philips S.A. LA Jón postal 2964 La Paz tel. 50029
- Brasil:** S.A. Philips Do Brasil; Avenida Paulista 2163; P.O. Box 8681; Sao Paulo S.P.; tel. 81-2161.
- Burundi:** Philips S.A.R.L., Avenue de Grèce, B.P. 900, Bujumbura
- Canada:** Philips Electronic Industries Ltd., Scientific and Electronic Equipment Division, Philips House, 116 Vanderhoof Avenue, Toronto 17 M 4G 2J1; tel. (416)-425-5161.
- Chile:** Philips Chilena S.A., Casilla 2687, Santiago de Chile; tel. 94001
- Colombia:** Industrias Philips de Colombia S.A., Calle 13 no. 51-03, Apartado Nacional 1505, Bogotá; tel. 473640
- Costa Rica:** Philips de Costa Rica Ltd., Apartado Postal 4325, San José; tel. 210111
- Danmark:** Philips Elektronik Systemer A/S Afd. Industr. & Forskning; Strandlodsvej 4 2300-København S; Tel. (0127) AS 2222; telex 27045
- Deutschland (Bundesrepublik):** Philips Elektronik Industrie GmbH, 35 Kassel-Bettenhausen, Miramstrasse 37; tel. (0561) 501521.
- Ecuador:** Philips Ecuador S.A., Casilla 343, Quito; tel. 233080
- Egypt:** Ph. Scientific Bureau 5 Sherif Str. Cairo - A.R. Egypt P.O. Box 1807; tel. 78457-57739
- Eire:** Philips Electrical (Ireland) Ltd., Newstead, Clonsillaagh, Dublin 14; tel. 976611
- El Salvador:** Philips de El Salvador, Apartado Postal 865, San Salvador; tel. 217441
- España:** Philips Ibérica S.A.E., Avenida de America, Apartado 2065, Madrid 17; tel. 2462200
- Ethiopia:** Philips Ethiopia (Priv. Ltd. Co.), P.O.B. 2565; Cunningham Street, Addis Abeba; tel. 48300
- Finland:** Oy Philips Ab. Postboks 10255, Helsinki 10; tel. 10915
- France:** Philips Industrie, Division de la S.A. Philips Industrielle et Commerciale 105 Rue de Paris, 93 062 Bobigny; tel. 830-11-11
- Ghana:** Philips (Ghana) Ltd., P.O.B. M 14, Accra; tel. 6619
- Great Britain:** Pye Unicam Ltd., York Street, Cambridge; tel. (0223) 58866
- Guatemala:** Philips de Guatemala S.A., Apartado Postal 238, Guatemala City; tel. 64857
- Hellas:** Philips S.A. Hellénique, 54. Ave Syngrou, Athens; tel. 230476, P.O. Box 153
- Honduras:** Hasbun de Honduras Apartado Postal 83, Tegucigalpa; tel. 2-9121...5
- Hong kong:** Philips Hong Kong Ltd., P.O.B. 2108, St. George's Building, 21st floor, Hong Kong; tel. 5-249246
- India:** Philips India Ltd., Shivsagar Estate, Block "A", Dr. Annie Besant Road, P.O.B. 6598, Worli, Bombay 18; tel. 370071
- Indonesia:** P. T. Philips Development Corporation, Jalan Proklamasi 33, P.O.B. 2287, Jakarta; tel. 51985-51986
- Iran:** Philips Iran Ltd., P.O.B. 1297, Teheran; tel. 662281
- Iraq:** Philips Iraq W.L.L. Munir Abbas Building 4th Floor; South Gate. P.O. box 5749 Baghdad; tel. 80409
- Island:** Heimilistaeki SF, Saetún 8, Reykjavik; tel. 24000
- Islas Canarias:** Philips Ibérica S.A.E., Triana 132, Las Palmas; Casilla 39-41, Santa Cruz de Tenerife
- Italia:** Philips S.p.A., Sezione PIT; Viale Elvezia 2, 20052 Monza; tel. (039) 361-441; telex 35290
- Kenya:** Philips (Kenya) Ltd., P.O.B. 30554, Nairobi; tel. 29981
- Malaysia:** Philips Malaya Sdn Bhd. P.O. Box 332, Kuala Lumpur; Selangor W. Malaysia; tel. 774411
- Mexico:** Philips Comercial S.A. de C.V., Uruapan 7, Apdo 24-328, Mexico 7 D.F.; tel. 25-15-40
- Nederland:** Philips Nederland B.V., Boschdijk, Gebouw VB, Eindhoven; tel. 793333
- Ned. Antillen:** N.V. Philips Antillana, Postbus 523, Willemstad; tel. Curaçao 36222-35464
- New Zealand:** Philips Electrical Industries (N.Z.) Ltd., Professional and Industrial Division, 70-72 Kingsford Smith Street, P.O.B. 2097, Lyall Bay, Wellington; tel. 73-156
- Nigeria:** Philips (Nigeria) Ltd., 6 Ijora Causeway, P.O.B. 1921, Lagos; tel. 45414/7
- Nippon:** Nihon Philips Corporation, P.O.B. 13, World Trade Center, 32nd Floor, Tokyo 105; tel. (03) 435-5211
- Norge:** Norsk A.S. Philips, Postboks 5040, Oslo; tel. 463890
- Österreich:** Oesterreichische Philips Industrie GmbH, Abteilung Industrie Elektronik, Partargasse 32, A-1230 Wien; tel. (0222)-831501.
- Pakistan:** Philips Electrical Co. of Pakistan Ltd., El-Markaz, M.A. Jinnah Road, P.O.B. 7101, Karachi; tel. 70071
- Paraguay:** Philips del Paraguay S.A., Casilla de Correo 605, Asuncion, tel. 8045-5536-6666
- Perú:** Philips Peruana S.A., Apartado Postal 1841, Lima; tel. 326070
- Philippines:** Philips Industrial Development Inc., 2246 Pasong Tamo P.O.B. 911, Makati Rizal D-708; tel. 889453 to 889456
- Portugal:** Philips Portuguesa S.A.R.L., Av. Eng. ° Duarte Pacheco, 6 - Lisboa - 1
- Rwanda:** Philips Rwanda S.A.R.L., B.P. 449, Kigali
- Saudi Arabia:** A. Rajab and A. Silsilah P.O. box 203 Jeddah - Saudi Arabia; tel. 5113-5114
- Schweiz-Suisse-Svizzera:** Philips A.G., Binzstrasse 15, Postfach 8027, Zürich; tel. 051-442211
- Singapore:** Philips Singapore Private Ltd. P.O. Box 340; Toa Payoh Central Post Office; Singapore 12; tel. 538811
- South Africa:** South African Philips (Pty) Ltd., P.O.B. 7703, 2, Herb Street, New Doornfontein, Johannesburg; tel. 24-0531
- Sverige:** Svenska A.B. Philips, Fack, Lidingövägen 50, Stockholm 27; tel. 08/635000
- Syria:** Philips Moyen-Orient S.A. Rue Fardoss 79 Immeuble Kassas and Sadate B.P. 2442 Damas; tel. 18605-21650
- Taiwan:** Yung Kang Trading Co. Ltd., San Min Building, Gnd Floor, 57-1 Chung Shan N Road, 2 Section, P.O.B. 1467, Taipei; tel. 577281
- Tanzania:** Philips (Tanzania) Ltd., Box 20104, Dar es Salaam; tel. 29571
- Thailand:** Philips Thailand Ltd., 283, Silom Road, Bangkok; tel. 36980, 36984-9
- Turkey:** Türk Philips Ticaret A.S., Posta Kutusu 504, Beyoglu; Gümüssüü Caddesi 78/80 Istanbul 1 Turkye
- Uganda:** Philips Uganda Ltd. p.o. Box 5300 Kampala; tel. 59039
- Uruguay:** Industrias Philips del Uruguay, Avda Uruguay 1287, Montevideo; tel. 915641 Casilla de Correo 294
- U.S.A.:** Philips Test and Measuring Instruments Inc.; 400 Crossways Park Drive, Woodbury, N.Y. 11797; tel. (516) 921-8880
- Venezuela:** C.A. Philips Venezolana, Apartado Postal 1167, Caracas; tel. 360511
- Zaire:** Philips S.Z.R.L., B.P. 1798, Kinshasa; tel. 31887-31888-31693
- Zambia:** Philips Electrical Ltd., Professional Equipment Division, P.O.B. 553 Kitwe; tel. 2526/7/8; Lusaka P.O. Box 1878

76101

For information on change of address:

N.V. Philips
Test and Measuring Instruments Dept.
Eindhoven - The Netherlands

For countries not listed:

N.V. Philips PIT Export Dept.
Test and Measuring Instruments Dept.
Eindhoven - The Netherlands