

OPERATING INSTRUCTIONS



TYPE **1216-A**

UNIT I-F AMPLIFIER
AND TYPE DNT DETECTORS

GENERAL RADIO COMPANY

OPERATING INSTRUCTIONS

TYPE 1216-A

**UNIT I-F AMPLIFIER
AND TYPE DNT DETECTORS**

Form 1216-0100-G
July, 1961

**G E N E R A L R A D I O C O M P A N Y
WEST CONCORD, MASSACHUSETTS, USA**

TABLE OF CONTENTS

Section 1 DESCRIPTION	1
1.1 General Description	1
1.2 Circuit	2
1.3 Controls and Connections	14
1.4 Accessories Supplied	16
1.5 Accessories Available	16
Section 2 OPERATION	16
2.1 General Principles	16
2.2 Detector Tuning	18
2.3 Use as a General-Purpose Detector	23
2.4 Use as a Null Detector	24
2.5 Use as a VSWR Indicator and in Measurement of Impedance Magnitude with the Admittance Meter	27
2.6 Use as a VSWR Indicator for Slotted Lines	27
2.7 Use in Calibrating R-F Attenuators	28
2.8 Use in Measuring Attenuation of Coaxial Cables	31
2.9 Use in Measuring Filter Characteristics	31
2.10 Use in Measuring Crosstalk in Coaxial Switches	32
2.11 Use in Measuring Antenna Patterns and Gain	32
2.12 Use in Measuring Field Strength	33
2.13 Low-Level Voltmeter Applications	34
2.14 Use as a Wave Analyzer	34
Section 3 SERVICE AND MAINTENANCE	35
3.1 General	35
3.2 Retuning Amplifier Peaking	36
3.3 Tube Voltage Chart	36
3.4 Crystal Check	37
3.5 Tube Replacement	37
PARTS LIST	37

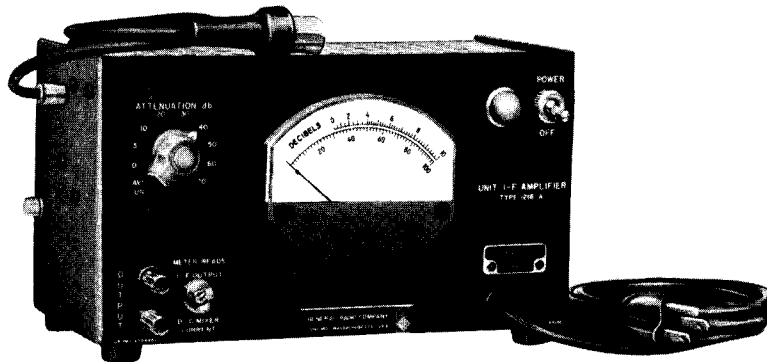

Panel View of Type 1216-A Unit I-F Amplifier

SPECIFICATIONS TYPE 1216-A UNIT I-F AMPLIFIER

Center Frequency: 30 Mc.

Bandwidth: Greater than 0.5 Mc at 3 db down; 9.5 Mc at 60 db down.

Sensitivity: From a 400-ohm source, 2 μ volts input required for 1% meter deflection (above noise), 50 μ volts input for full-scale meter deflection. These are open-circuit source voltages.

Noise Figure: Approx. 5 db.

Attenuator Range: 0-70 db in 10-db steps.

Attenuator Accuracy: $\pm(0.3 \text{ db} + 1\%)$.

Output Circuit Bandwidth: (Modulation) 0.4 Mc.

Output Impedance: 600 ohms.

Maximum Output Voltage: 2 volts open circuit.

Terminals: Input, TYPE 874 Connector on 2-foot cable; output, $\frac{3}{4}$ -inch-spaced TYPE 938 Binding Posts.

Supplementary Power Supply Output: 300 volts dc at 30 ma; 6.3 volts ac at 1 amp. With this power supply, full output will not be obtained from a Unit Oscillator, but output is ample for heterodyne use.

Power Supply: 105-125 (or 210-250) volts, 50 to 60 cps. Power input, 45 watts at full load. Can also be operated at 400 cps where line voltage does not drop below 110 v.

Tube Complement: Two 6CB6; one each, 6AK5, 6AL5, 6U8, 0B2.

Accessories Supplied: Spare fuses; three-wire power cord attached.

Mounting: Gray crackle-finish aluminum panel and sides. Aluminum cover finished in clear lacquer.

Dimensions: Width 10 $\frac{1}{4}$, height 5 $\frac{3}{4}$, depth 6 $\frac{1}{4}$ inches (260 by 146 by 159 mm) over-all.

Net Weight: 8 $\frac{1}{4}$ pounds (3.8 kg).

SPECIFICATIONS TYPE DNT DETECTOR

Frequency Range: Complete detector assemblies are available for operation from 25 to 950 Mc on fundamental frequencies. Higher frequency operation is obtainable by using oscillator harmonics.

DETECTOR	FUNDAMENTAL RANGE
Type DNT-1	40 to 530 Mc
Type DNT-2	40 to 280 Mc
Type DNT-3	220 to 950 Mc
Type DNT-4	870 to 2030 Mc

Any of these assemblies may be converted into either of the other two by merely adding an appropriate local oscillator for that range.

Sensitivity: Amplifier gain of 100 db provides a maximum sensitivity of about 80 microvolts for full-scale meter deflection. Less than 5 microvolts from a 50-ohm source will give a meter deflection of 1% (over residual noise) at frequencies between 50 and 950 Mc. Sensitivity is slightly poorer on harmonic operation at higher frequencies.

Selectivity: Bandwidth between half-power points (3 db down) is 0.7 Mc. Response is down more than 20 db at

2 Mc from center frequency, and 60 db down at 5 Mc.

Attenuator: Built-in precision attenuator has 0-, 3-, 10-, 20-, 30-, 40-, 50-, 60-, and 70-db steps with an accuracy of $\pm(0.3 + 1\%$ of indicated attenuation). Mixer is linear over more than 80 db, thus permitting extremely reliable and rapid voltage-level measurements.

Output Meter: Linear relative voltage scale and also a db scale for measuring relative r-f signal level.

Shielding: Mixer unit is well shielded and the amplifier circuits are shielded and isolated to obtain negligible leakage and regeneration.

Output: Modulation envelope is available at output terminals. The output circuit bandwidth is 0.4 Mc and a maximum open-circuit output of 2 volts is available. Output impedance is 600 ohms.

Automatic Volume Control: Separate diode supplies a-v-c voltage to second amplifier stage for use in null detection.

Power Supply: I-F amplifier operates from 115-volt (or 230-volt) line and also has a separate built-in power supply to operate the local oscillator.

Net Weight: Over-all weight of Detector including all cables is approximately 17 pounds (7.8 kg).

Operating Instructions
for
TYPE 1216-A UNIT I-F AMPLIFIER
AND
TYPE DNT DETECTORS

SECTION 1.0 DESCRIPTION

1.1 GENERAL DESCRIPTION

The Type 1216-A Unit I-F Amplifier is a four-stage high-gain, intermediate-frequency amplifier operating at a frequency of 30 Mc with a bandwidth of 0.7 Mc. The relative signal level is indicated on a meter and the modulation is passed through a cathode-follower amplifier and is available at binding posts on the panel. The meter is calibrated in a decibel scale and in a linear scale. A precision resistance-type step attenuator is provided for determining relative signal levels beyond the range of the meter.

The amplifier is normally used in conjunction with a Type 874-MR Mixer Rectifier and a Unit Oscillator¹ to form a sensitive, wide-frequency-range, well-shielded, V H F and U H F detector which is referred to as a Type DNT Detector.² An incoming signal and the signal from the Unit Oscillator, which is set to a frequency 30 Mc above or below the frequency of the signal to be detected, are mixed in the Mixer Rectifier, and the 30-Mc difference-frequency produced is amplified and detected by the instrument. Satisfactory performance is also obtained when the signal is heterodyned with harmonics of the Unit-Oscillator frequency; hence, a very wide frequency range can be covered. The upper frequency limit³ is approximately 5000 Mc with the Type 874-MR Mixer Rectifier.

¹Most commercial oscillators and signal generators can be used in place of the Unit Oscillators as local oscillators, if desired.

²See Type DNT Detector specifications.

³The upper frequency limit is dependent on the frequency range of the Unit Oscillator used. See Type DNT Detector specifications for actual range.

GENERAL RADIO COMPANY

This heterodyne-type high-frequency detector has many uses, some of which are:

1. As a null detector for the Type 1602 UHF Admittance Meter, and for other bridges and null-type devices operating at very high and ultra-high frequencies.

2. As an indicator of relative voltage levels for such uses as:

- (a) Measuring voltage standing-wave ratio using the voltage-ratio method with the Type 1602 UHF Admittance Meter.
- (b) Measuring voltage standing-wave ratio with slotted lines.
- (c) Calibrating attenuators.
- (d) Measuring attenuation of coaxial cables.
- (e) Measuring relative signal strength.
- (f) Checking cross-talk between channels in coaxial switches and similar devices.
- (g) Measuring filter characteristics.
- (h) Measuring voltage standing-wave ratio with a directional coupler.
- (i) Monitoring voltage levels.
- (j) Measuring antenna patterns and antenna gain.

3. When calibrated or standardized at one level using a signal generator, voltmeter, or bolometer bridge, the detector can be used as:

- (a) A VHF and UHF low-level voltmeter.
- (b) A VHF and UHF wave analyzer.
- (c) A field-strength-measuring device.

The Unit I-F Amplifier includes two internal power supplies, one for operating its own circuits and the other for operating the heterodyning Unit Oscillator.

1.2 CIRCUIT

1.21 Detector: A Type DNT Detector consists of a Type 1216-A Unit I-F Amplifier in combination with a Type 874-MR Mixer Rectifier and a Unit Oscillator.⁴ The signal to be detected is heterodyned down to a 30-Mc intermediate frequency in the mixer and then amplified in the amplifier. The circuit of the detector is shown in Figure 1.

The incoming signal to be detected is fed into the Mixer Rectifier through the coaxial line shown and impressed across the Type 1N21-B crystal. A relatively large voltage from the Unit Oscillator (local oscillator) is also fed into the Mixer Rectifier through another coaxial

⁴See Type DNT Detector specifications.

TYPE 1216-A UNIT I-F AMPLIFIER

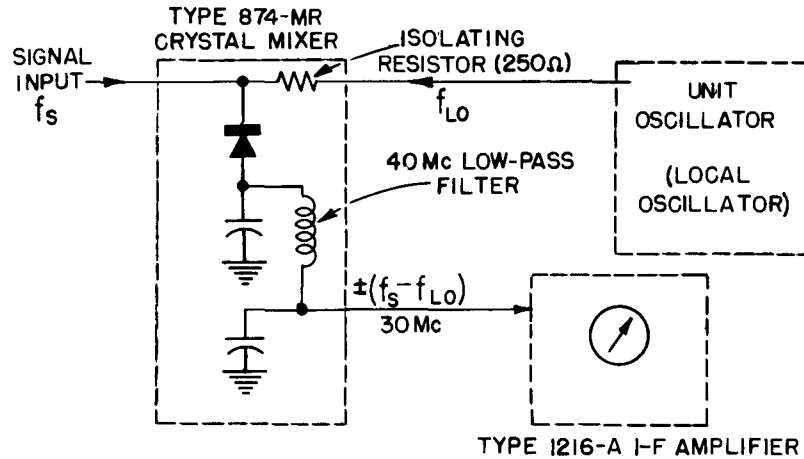

Figure 1. Block diagram showing method of detecting a high-frequency signal by heterodyning it with a signal from a local oscillator and amplifying the difference frequency with the Type 1216-A Unit I-F Amplifier.

line and also impressed across the crystal after passing through a 250-ohm series resistor. The purpose of the resistor is to prevent the effective local-oscillator impedance at the signal frequency, which appears in parallel with the crystal, from becoming low enough to reduce the sensitivity significantly.

One terminal of the crystal is directly connected to the center conductor of the coaxial line, and the other is connected to the outer conductor through an r-f bypass capacitor. The combination of the high-frequency signal and the voltage from the local oscillator in the non-linear mixer produces an output signal, one component of which has a frequency equal to the difference in the frequencies of the high-frequency signal and the local oscillator. As shown in Figure 2, the amplitude of the difference-frequency signal is proportional to the amplitude of the high-frequency signal and practically independent of the local-oscillator voltage as long as the local-oscillator voltage is relatively large. In general, good linearity is obtained at signal inputs up to about 100 millivolts when the local-oscillator input is the order of one volt.

The r-f bypass capacitor on the ground side of the crystal has an appreciable impedance at the difference frequency, and as a result a difference-frequency voltage appears across this capacitor. The difference-frequency voltage is then passed through a built-in low-pass filter, which cuts off at 40 Mc, and then into the i-f amplifier. If the difference-frequency signal is 30 Mc or close to this frequency, it will

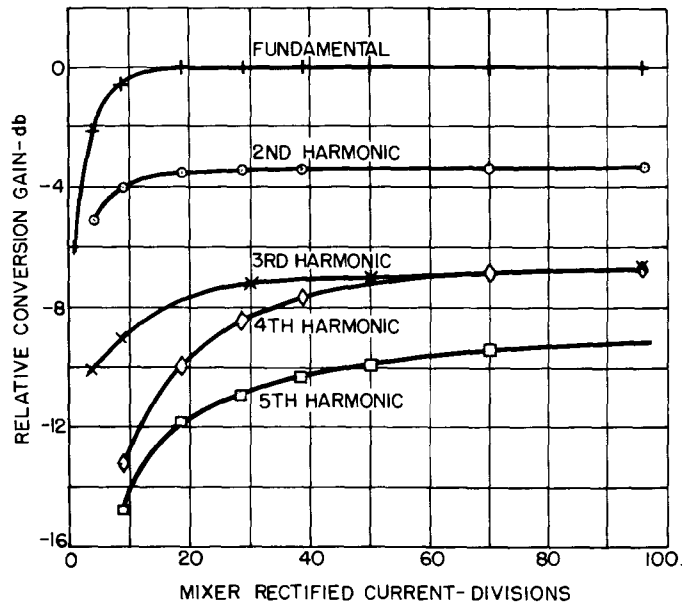

Figure 2. Curves showing the relative gain of a typical mixer as a function of the rectified mixer current for the fundamental and harmonics of the local oscillator.

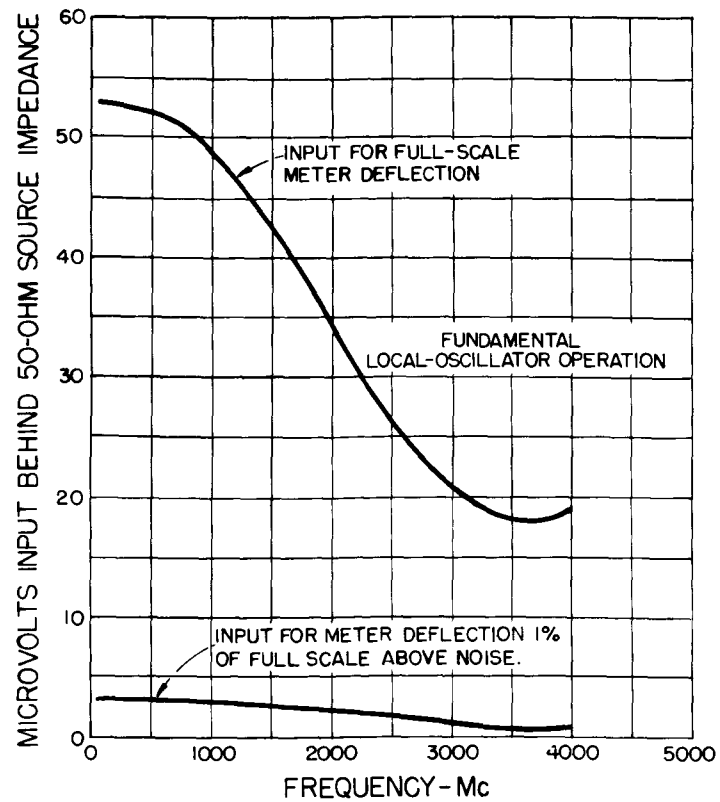

Figure 3a. Average sensitivity of a typical detector operating on the fundamental of the local oscillator.

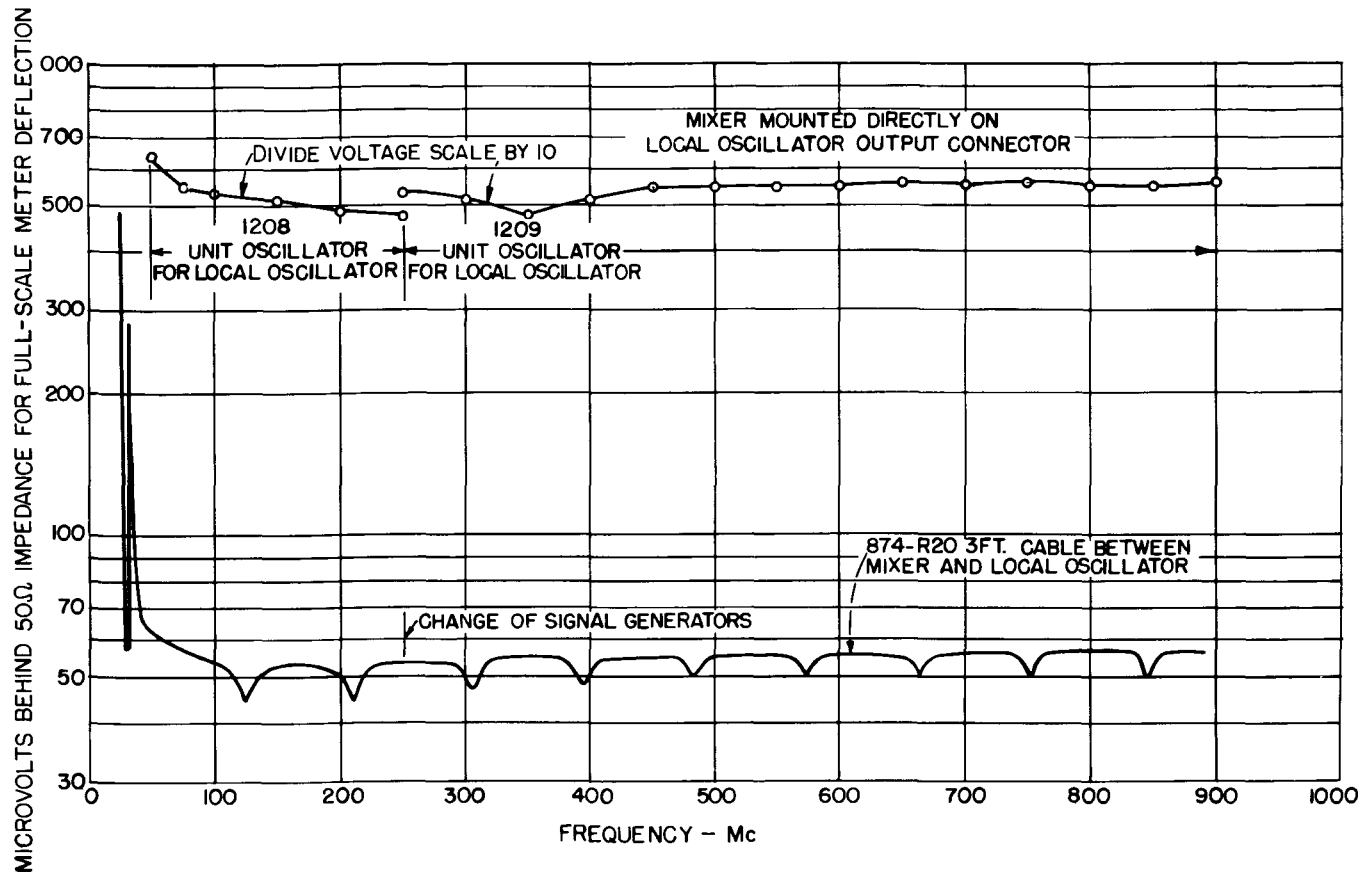

Figure 3b. Detailed low-frequency sensitivity curve of a typical detector operating on the fundamental of the local oscillator.

GENERAL RADIO COMPANY

be amplified by the Type 1216-A Unit I-F Amplifier and a visual indication will be produced on the meter, and, if the signal is modulated, the modulation will appear at the binding posts labeled OUTPUT.

1.211 Shielding: The Type DNT Detectors have excellent shielding since the signal circuit is confined to the well-shielded Mixer Rectifier unit. The low-pass filter prevents signals from leaking into the mixer through the i-f amplifier. The amplifier itself is also well shielded to prevent stray pickup and to minimize regeneration possibilities.

1.212 Sensitivity: The variation in sensitivity with frequency of a typical detector is shown in Figure 3. The variations in the curves are caused by the changes in the effective impedance of the local-oscillator circuit with frequency which appears in parallel with the crystal. At frequencies above 1000 Mc, the sensitivity rises as a result of resonance

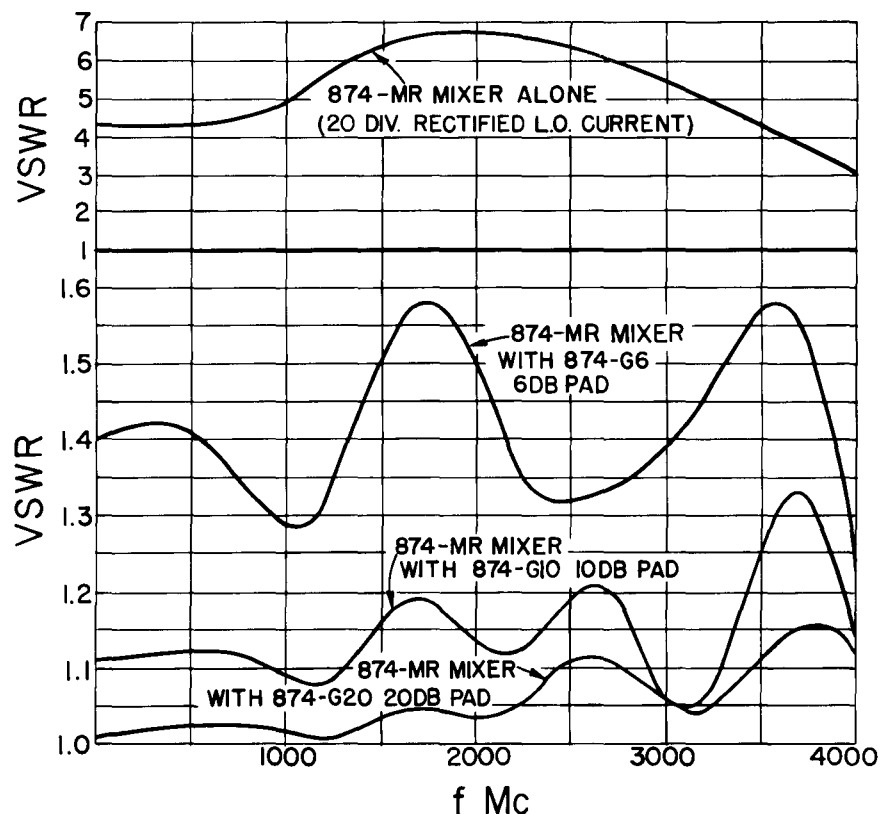

Figure 4. VSWR of a typical mixer alone and of the mixer with various pads as a function of frequency. The effective generator VSWR obtained by inserting a Type 874-G10,10-db Pad or a Type 874-G20,20-db Pad in the oscillator output circuit is approximately the same as that indicated for the mixer with the pads inserted.

TYPE 1216-A UNIT I-F AMPLIFIER

in the crystal. A 1% meter deflection over residual noise is produced by a $3 \mu\text{v}$ r-f signal behind a 50-ohm source impedance in a typical instrument.

1.213 Input Impedance: The input coaxial line is terminated by the crystal mixer in parallel with roughly the 250-ohm resistor. The voltage-standing-wave ratio (VSWR) produced by a typical detector terminating a 50-ohm line is shown in Figure 4. With a Type 874-G10, 10-DB Pad or Type 874-20, 20-DB Pad ahead of the Mixer Rectifier, the match is greatly improved as shown in the figure. For a better match, a double or triple stub transformer can be used ahead of the pads.

1.214 Mixer Linearity: The over-all mixer linearity is excellent over the full 70-db attenuator range when the mixer is operated on the fundamental of the local oscillator and when the local-oscillator drive is adequate. Figure 5 shows the measured deviation from linearity for various amounts of local-oscillator drive. Note that good linearity is obtained over the whole range of the attenuator as long as the rectified crystal current is above 5 divisions when the mixer is operated on the fundamental of the local oscillator. Somewhat larger rectified currents are required to obtain an equivalent range of linearity when harmonic operation is used.

Interpolation between attenuator steps can be made using the DB scale on the meter.

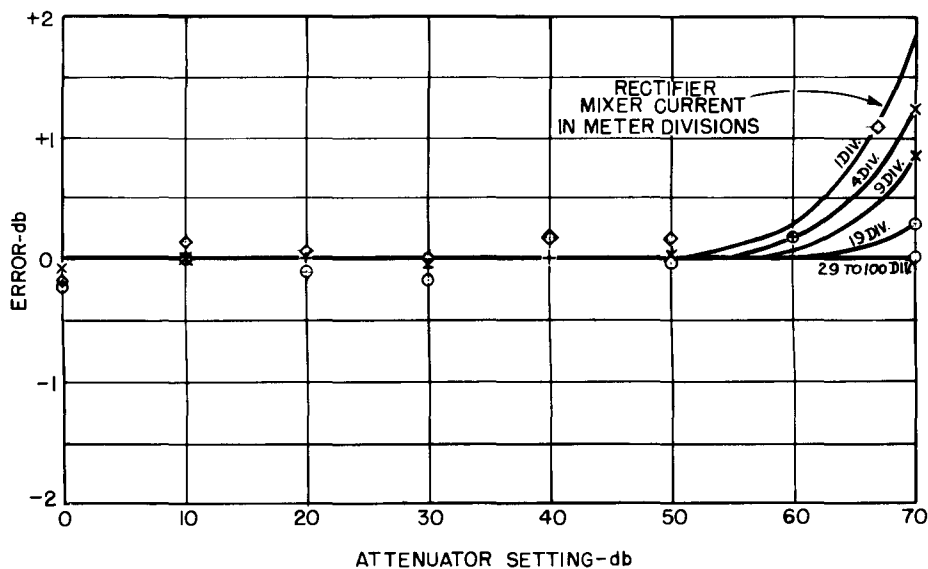

Figure 5. Over-all error in signal-level measurements for a typical Type DNT Detector Assembly as a function of attenuator setting for various values of rectified mixer current. Full-scale meter deflection was used in determining these data.

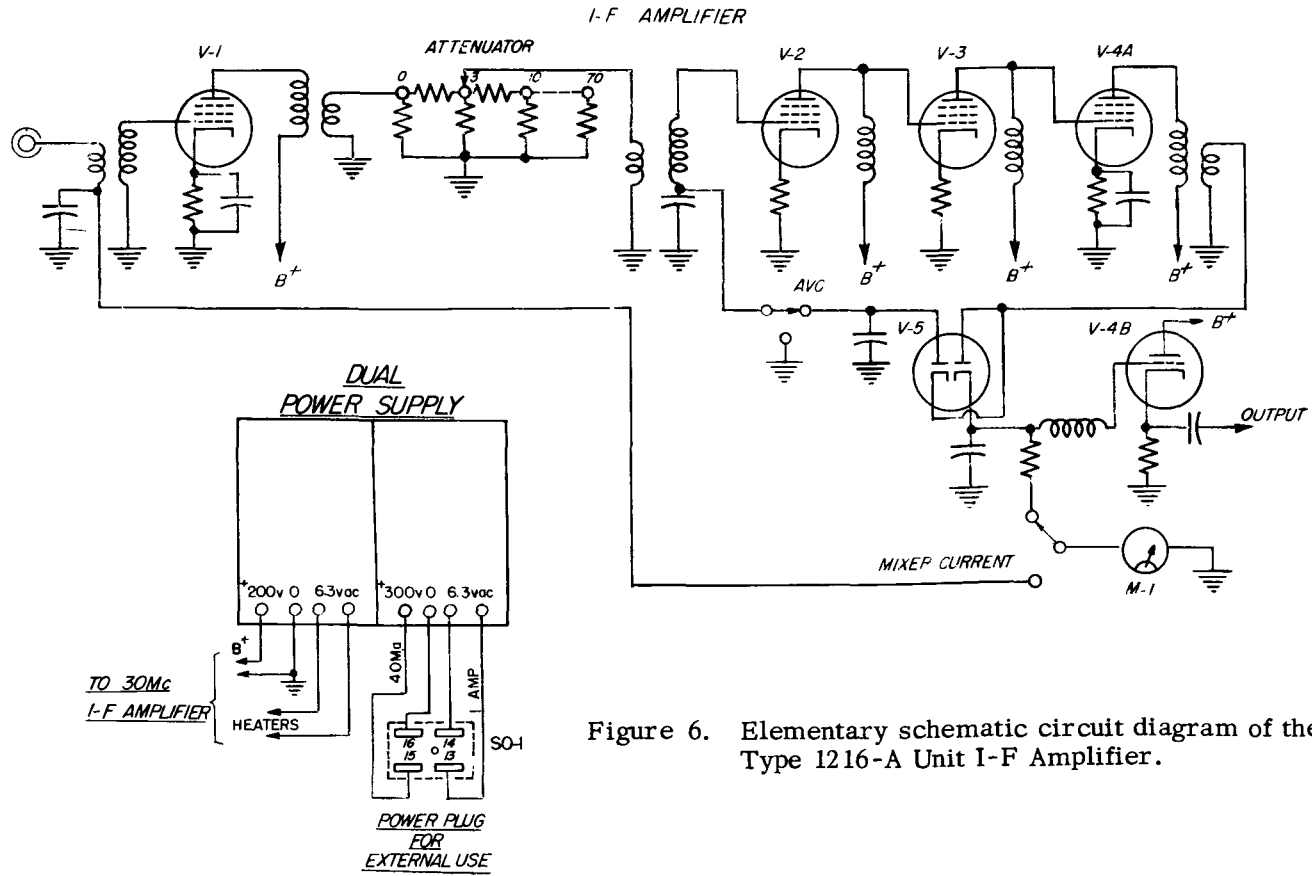

Figure 6. Elementary schematic circuit diagram of the Type 1216-A Unit I-F Amplifier.

TYPE 1216-A UNIT I-F AMPLIFIER

1.22 I-F Amplifier: The Type 1216-A I-F Amplifier consists of four synchronously tuned i-f amplifier stages, a detector, a video amplifier stage, an r-f attenuator, and two power supplies. A simplified circuit diagram is shown in Figure 6 and a complete circuit diagram in Figure 22.

The instrument is designed to operate from a 400-ohm source impedance, which is the nominal output impedance of the Type 874-MR Mixer Rectifier. A closely coupled, tuned transformer provides a step-up from the 400-ohm input to the higher input impedance of the tube.

The step attenuator follows the first stage. It is a precision resistive type having a 70-db range. Two separate pi sections are alternately switched into the circuit for the 3 and 10 db steps. A ladder attenuator is used for the higher attenuations. The attenuator impedance is 50 ohms, and a tuned step-down transformer is used between the plate of the first stage and the attenuator input to obtain the desired bandwidth and impedance match. A similar tuned step-up transformer is used between the attenuator output and the grid of the succeeding tube.

Since the source and load on the attenuator are tuned circuits, their impedances will vary as the frequency deviates from the center frequency, and an error in the low-attenuation steps will be produced. The bandwidth of the source and load circuits are made as wide as possible to minimize this error. Figure 7 shows the error in db obtained for various attenuator steps as a function of the deviation from the center frequency.

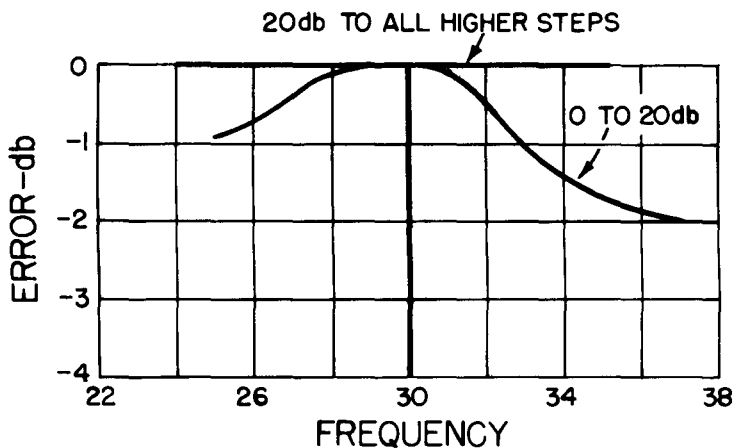

Figure 7. Frequency characteristic of attenuator in the amplifier. Note that the response is independent of frequency except at the lowest attenuation settings.

GENERAL RADIO COMPANY

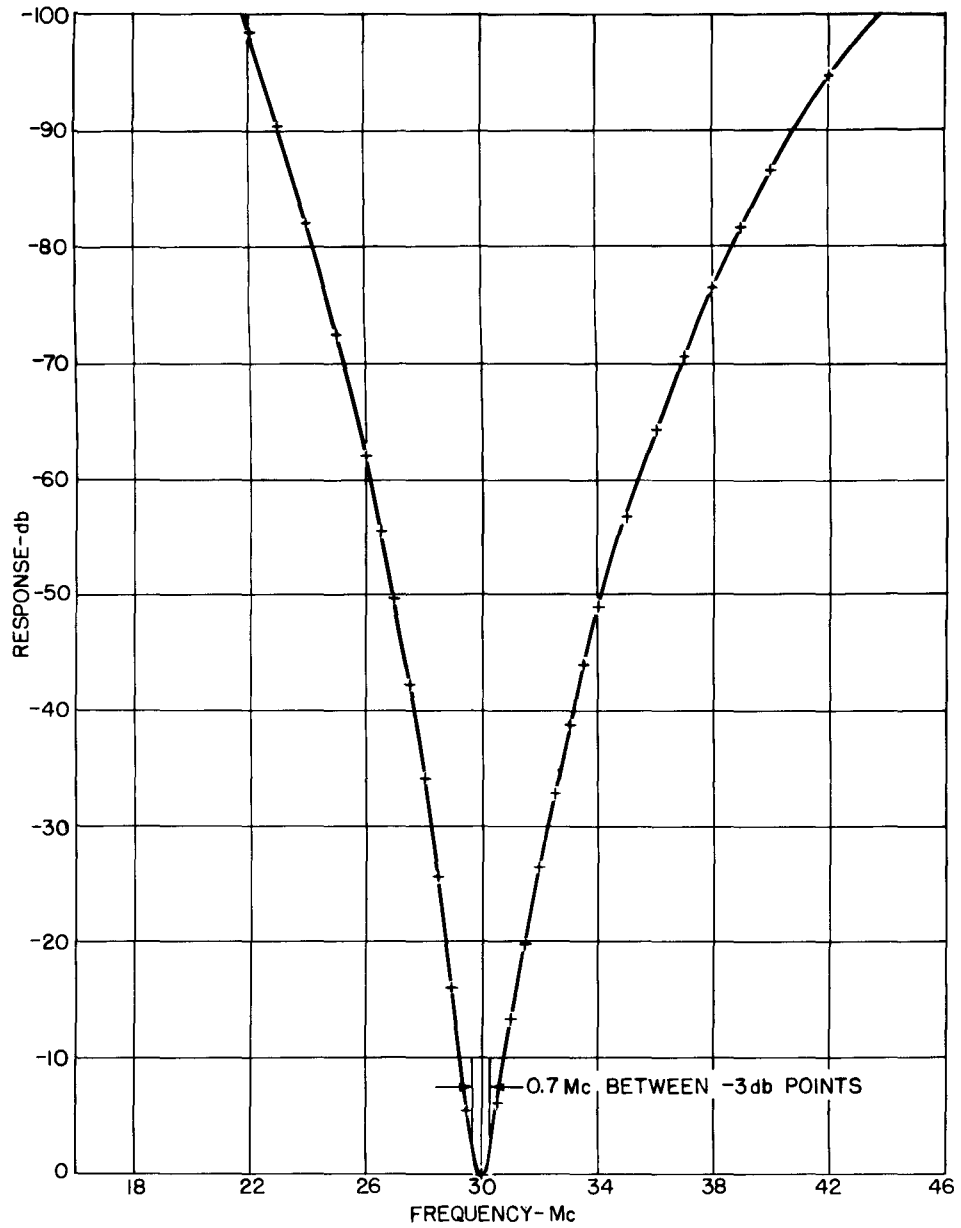

Figure 8. Over-all selectivity curve of a typical Type 1216-A Unit I-F Amplifier.

TYPE 1216-A UNIT I-F AMPLIFIER

Three synchronously tuned amplifier stages follow the attenuator. The screen circuits on all the amplifiers are fed from a regulated supply to minimize gain fluctuations caused by line voltage variations. The bandwidth between half-power points is about 0.7 Mc. Figure 8 shows a typical response curve.

The second detector is a double diode. One diode is used to demodulate the signal. The rectified d-c output of the diode is measured by a 200- μ a meter and is used as an indication of signal level. A large voltage is applied to the diode to obtain good meter linearity. Figure 9 shows the linearity characteristic of a typical amplifier. At the two lowest attenuator settings, the random noise generally affects the linearity slightly at small meter deflections. As shown in the figure, the zero db meter indication at zero db attenuator setting can be in error as much as 1 db. This error decreases very rapidly with signal level and is negligible at a 5-db meter indication.

On pulsed signals, the meter will read the average signal level, and, since the peak signal can be many times larger than the average

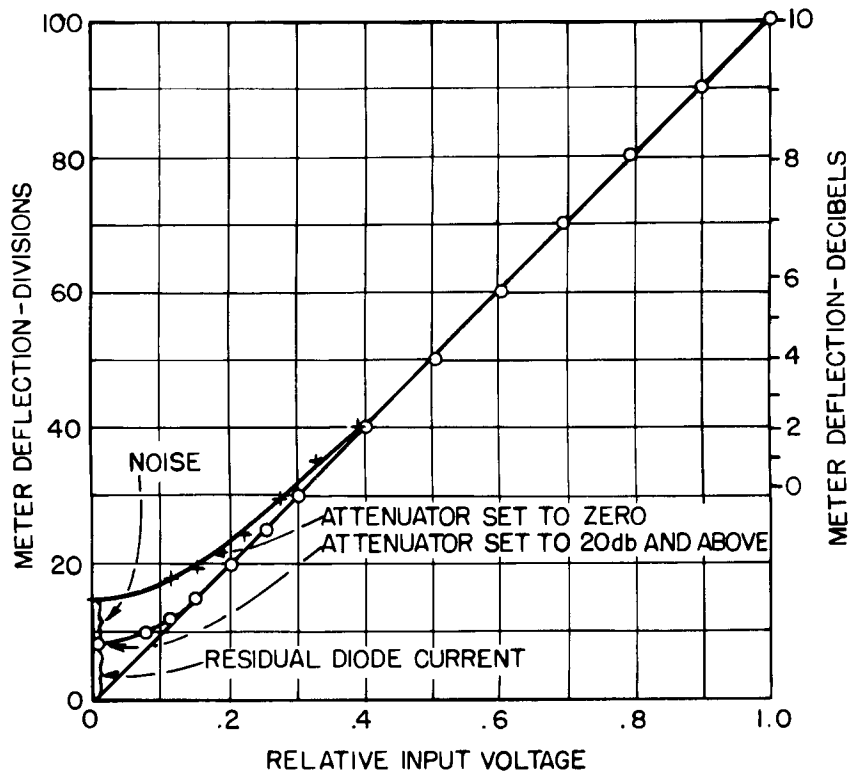

Figure 9. Curve showing linearity of over-all response of the amplifier and meter circuits (CW Signal).

GENERAL RADIO COMPANY

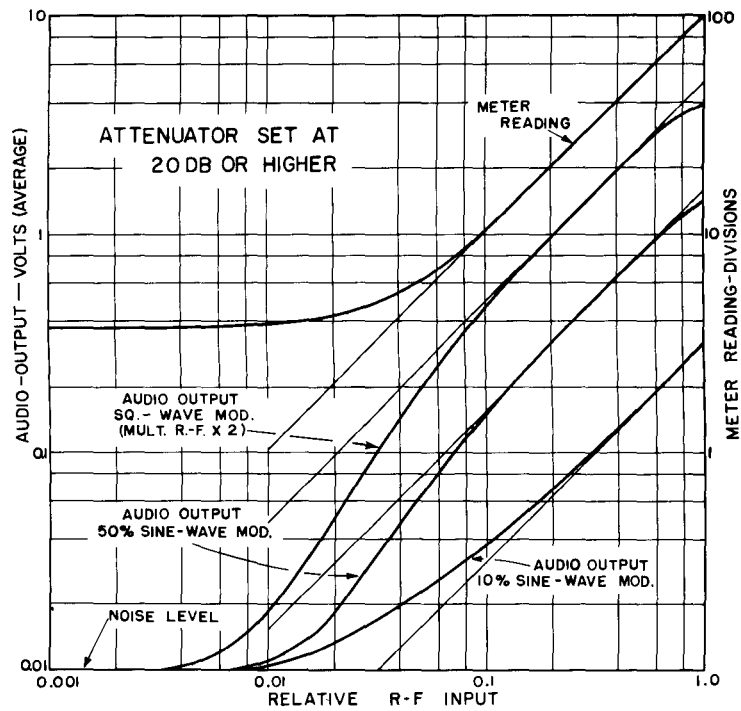

Figure 9A. Linearity of modulation output as a function of r-f input.

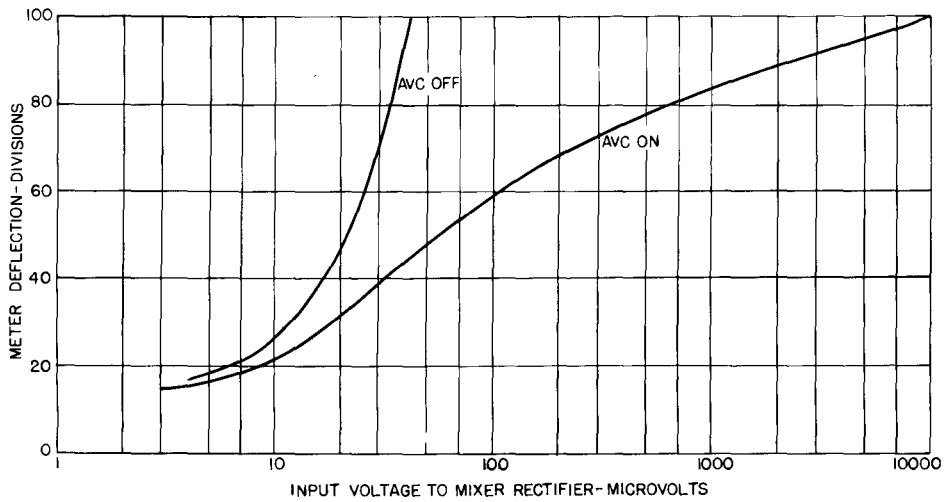

Figure 10. A-V-C characteristic of a typical instrument.

TYPE 1216-A UNIT I-F AMPLIFIER

signal, the meter is not a good indicator of signal level for pulsed signals and care must be taken not to overload the amplifier. (See Fig. 9A.)

The a-c output of the second detector is fed into a cathode-follower stage and then to the binding posts on the panel. The output impedance is 600 ohms, and the peak open-circuit output voltage is 2 volts. The cathode-follower stage has a bandwidth of 0.4 Mc.

The second half of the double diode supplies the AVC voltage, which is fed through a series of R-C filters to the grid of the second amplifier tube. Input-impedance changes of the amplifier tube with bias voltage are minimized by the use of an unbypassed cathode resistor. The AVC bias is normally short-circuited by contacts on the attenuator switch, except when the switch is set to the AVC ON position. Figure 10 shows a typical AVC characteristic. The AVC voltage developed is proportional to the average signal level: hence, it is not effective for short pulses.

Provision is also made for checking the local-oscillator voltage applied across the mixer crystal. A switch is provided which connects the meter to read the rectified crystal current. A full-scale reading corresponds to a crystal current of about 2.5 ma into a 400-ohm load.

Two completely separate power supplies are provided: One uses a full-wave selenium rectifier and supplies the amplifier. A regulated screen supply is obtained through the use of a Type OB2 Reference Tube. The second supply, a bridge rectifier, is provided to drive the external Unit Oscillator usually used with the Mixer Rectifier. It supplies approximately 300 volts at 40 ma and 6.3 volts at 1 amp.

1.23 Local Oscillator: One of the General Radio Unit Oscillators is recommended for use as an oscillator and is included in the Type DNT Detectors. These oscillators have wide frequency ranges, have high output, are small in size, and can be run directly from the power supply contained in the i-f amplifier. The power connector on these oscillators will plug directly into a mating jack on the side of the i-f amplifier.

Most commercially available oscillators and signal generators make suitable local oscillators in place of the Unit Oscillators.

Operation on the fundamental frequency range is recommended to avoid confusion with spurious responses, but if low-pass filters are used, or if care is taken in tuning, satisfactory performance can be obtained when operating on harmonics. (See Section 2.2.) The frequency range of the detector, of course, extends 30 Mc below the lowest oscillator frequency obtainable and 30 Mc above the highest oscillator frequency obtainable. The frequency ranges when operating on the fundamental for various Unit Oscillators are:

GENERAL RADIO COMPANY

Type Number		Detector Frequency Range
1215	(Included in Type DNT-2 Detector)	40 to 280 Mc
1208	(Included in Type DNT-1 Detector)	40 to 530 Mc
1209	(Included in Type DNT-3 Detector)	220 to 950 Mc
1218-A	(Included in Type DNT-4 Detector)	870 to 2030 Mc

Below 40 Mc the sensitivity rapidly decreases as a result of the 40-Mc low-pass filter. Typical performance is shown in Figure 3. At signal frequencies in the vicinity of 30 Mc, the signal frequency as well as the difference frequency will be amplified and spurious beats having a frequency equal to the difference in frequency between the signal and i-f will be generated in the second detector. This behaviour has no effect on the null or voltage-ratio performance of the instrument but may affect the modulation signal appearing at the output terminals.

The mixing efficiency and linearity range of the mixer will vary with local-oscillator signal level. At low voltages the efficiency will be low and the linear range small. As the voltage increases, the mixing efficiency increases, reaching a broad maximum, and then decreases. (See Figure 2.) The range of linearity is also increased with increased local-oscillator voltage. At very large local-oscillator voltages, the noise generated by the crystal will increase markedly, thus causing an increase in the residual meter indication when the attenuator is set at low values; in the extreme, the crystal will be destroyed.

1.3 CONTROLS AND CONNECTIONS

A two-foot coaxial cable terminating in a Type 874 Connector is provided on the amplifier for connection to the i-f signal source, usually a Type 874-MR Mixer Rectifier. The tuning of the input transformer is adjusted to compensate for the effect of this cable and the output impedance of the Mixer Rectifier. If a longer cable is used or if the source impedance is greatly different, the tuning of the first transformer should be readjusted when maximum sensitivity is desired. The coaxial connector labeled "L. O." on the Mixer Rectifier is for connection to the local oscillator and the opposite coaxial connector is for connection to the signal source. (See Figure 11.)

The multipoint connector, located on the right side of the case, is provided for connecting a Unit Oscillator to the internal power supply.

A step switch, which controls the attenuator and which is labeled ATTENUATION db, is located on the left side of the panel. It has nine attenuation steps, 0, 3, 10, 20, 30, 40, 50, 60 and 70 db. A tenth step, labeled AVC ON, switches the automatic volume control on.

Below the attenuator switch is located a toggle switch whose positions are labeled METER READS, I-F OUTPUT, and D-C MIXER CURRENT. In the I-F OUTPUT position, the meter is connected to the diode detector and hence indicates relative signal level. In the D-C MIXER

TYPE 1216-A UNIT I-F AMPLIFIER

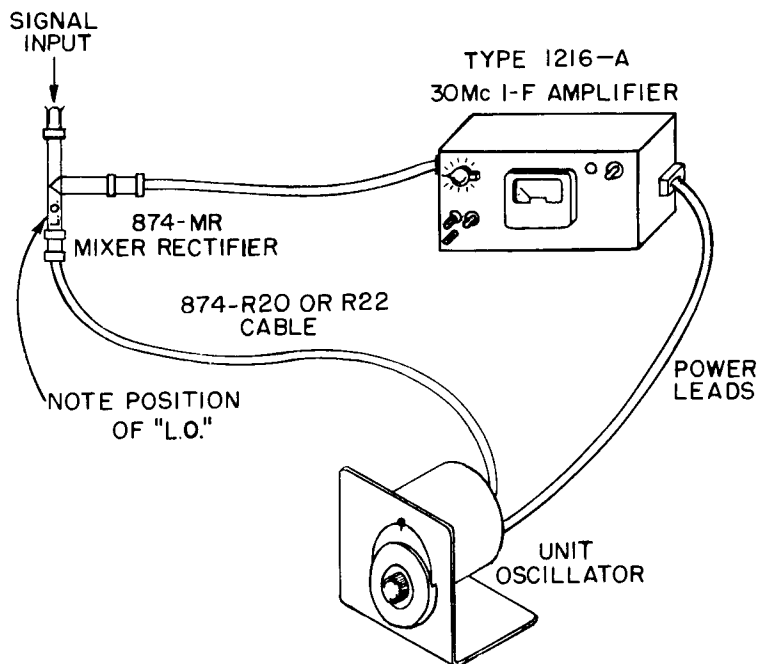

Figure 11. Diagram of method of connecting instruments to form a detector.

CURRENT position, the meter is connected to the input cable through a 400-ohm resistor and reads the rectified current produced by the action of the local-oscillator voltage on the mixer crystal. A full-scale reading corresponds to a current of about 2.5 ma into a 400-ohm load.

The meter is calibrated both in a decibel scale and in a linear scale.

The power OFF-ON switch is located at the right of the meter. The instrument is normally connected for a 105-125 volt, 50-60 cycle input. For 210-250 volt operation, remove the cover by loosening the thumbscrew found at the rear of the left side of the case, and connect the incoming line across terminals #1 and #4. Terminals #2 and #3 should be connected together. For 105-125 volt operation, connect terminal #1 to #3, terminal #2 to #4, and the line across terminals #1 and #2.

Both sides of the incoming line are fused with 1 ampere fuses (0.5 amp for 230-v. operation). These fuses are mounted inside the instrument on the transformer terminal plate below the chassis. Remove the power-line plug from the a-c outlet when changing fuses.

GENERAL RADIO COMPANY

1.4 ACCESSORIES SUPPLIED

A spare box of fuses is supplied.

1.5 ACCESSORIES AVAILABLE

The Type 874-MR Mixer Rectifier and a series of Unit Oscillators are available for use with the i-f amplifier to form a detector. The Type 874-MR Mixer Rectifier is fitted with Type 874 Connectors. If the signal source terminates in another type of connector, one of the adaptors listed in the General Radio Company catalog usually can be used to make the connection between the two types of connectors. Type 874-G10 and -G20 Pads are available for insertion ahead of the Mixer Rectifier to provide a better impedance match. Type 874-F500 and -F1000 Low-Pass Filters are available for eliminating harmonic responses; these and various other coaxial elements, such as Tees, Stubs, etc., are also listed in the General Radio Company catalog. The small-diameter, double-shielded, Type 874-R22 Patch Cord is very useful in many applications.

SECTION 2.0 OPERATION

2.1 GENERAL PRINCIPLES

The Type 1216-A Unit I-F Amplifier, the Type 874-MR Mixer Rectifier, and an appropriate Unit Oscillator should be connected as shown in Figure 11. (Double-shielded cables⁵ should be used throughout in applications in which leakage may cause difficulty.) The mixer should be connected to the signal source with the METER READS switch set to D-C MIXER CURRENT, the local-oscillator output adjusted by rotating or shifting the position of the coupling loop until the meter reads between 5 and 100 divisions. Do not operate with crystal currents over 100 divisions or an excessive amount of residual noise will be produced and the crystal may be damaged.

Since the crystal is connected directly to the signal source, the effective signal-circuit impedance appearing at the crystal will affect the magnitude of the local-oscillator voltage actually developed across the crystal. Therefore, the adjustment should be made with the source connected. When removing the mixer from the source, the local-oscillator voltage developed across the crystal may rise over the prescribed

⁵Type 874-R20 Patch Cords use double-shielded coaxial cable 0.365" in diameter. Type 874-R22 Patch Cords use double-shielded coaxial cable 0.201" in diameter and hence are more flexible.

TYPE 1216-A UNIT I-F AMPLIFIER

limits. Therefore, use caution when disconnecting the mixer from the source unless a pad is left connected to the input of the mixer. The pad makes the effective impedance seen by the local oscillator practically independent of the signal-circuit impedance and thus stabilizes the rectified current produced.

The effective impedance of the signal circuit at the local-oscillator frequency appearing in parallel with the crystal may be very low, making it difficult to obtain sufficient local-oscillator voltage developed across the crystal. The effective source impedance in these cases can usually be increased and adequate local-oscillator drive obtained if a section of Type 874-L10 Air Line is inserted in the signal circuit. The use of a pad between the signal source and the mixer also eliminates this difficulty, but, of course, also causes a reduction in sensitivity.

A d-c return circuit must be provided for the crystal either in the local-oscillator circuit or signal circuit. D-C resistances from zero to about 250 ohms can be tolerated. The Unit Oscillators all have output coupling loops which provide adequate d-c return circuits.

Since the local-oscillator voltage appears across the crystal, it also appears across the signal input connector. It is fairly large in magnitude and in some applications may cause undesirable reactions in the signal circuit, such as affecting voltmeters. If maximum sensitivity is not required, the magnitude of this voltage can be reduced by inserting pads between the mixer and the signal source.

There is no d-c isolation between the signal circuit and the crystal, hence the presence of d-c on the signal circuit should be avoided. Even the d-c produced by the voltmeter on the Type 1021 Signal Generators at high output levels can bias the mixer and affect the performance somewhat, as well as cause the voltmeter to be in error. The insertion of a Type 874-K Series Capacitor, or a stub, between the mixer and the signal circuit prevents difficulties from d-c coupling.

Any extraneous 30-Mc signal fed into the mixer from the signal circuit will pass through it and into the i-f amplifier with very little attenuation, and cause a residual meter reading. If measurements are to be made in the presence of strong extraneous 30-Mc signals, particularly if a radiating system is under test, a high-pass or band-pass filter should be inserted ahead of the mixer to prevent the 30-Mc signal from reaching the mixer.

Also, if a strong spurious signal is present at the image frequency (60 Mc to one side of the signal frequency), or on one of the possible harmonic responses, a spurious response will result. The image frequency difficulty can be overcome by shifting the local oscillator to the other side of the signal frequency. The harmonic difficulty can be eliminated by inserting an appropriate low-pass filter ahead of the mixer.

GENERAL RADIO COMPANY

2.2 DETECTOR TUNING

Since the crystal is a non-linear element and the local-oscillator voltage is large, the mixer will generate harmonics of the local-oscillator frequency, and a 30-Mc difference frequency will be produced whenever the difference between the signal frequency and a harmonic of the local oscillator is equal to 30 Mc. In general, significant harmonics of the signal frequency will not be produced in the mixer unless the signal level is very high. Operation on harmonics of the local-oscillator frequency provides a means for extending the frequency range of the detector far beyond the local-oscillator range. However, it can also lead to confusion as will be explained later.

As previously mentioned, significant harmonics of the signal frequency are not generally produced in the mixer since the signal voltage is usually small. However, a significant harmonic content may be present in the signal applied to the mixer. For instance, when the Type 1216-A Unit I-F Amplifier is used as a detector for a null-type instrument, the instrument may be close to balance at the fundamental frequency but far off balance at harmonic frequencies, and, as a result, the

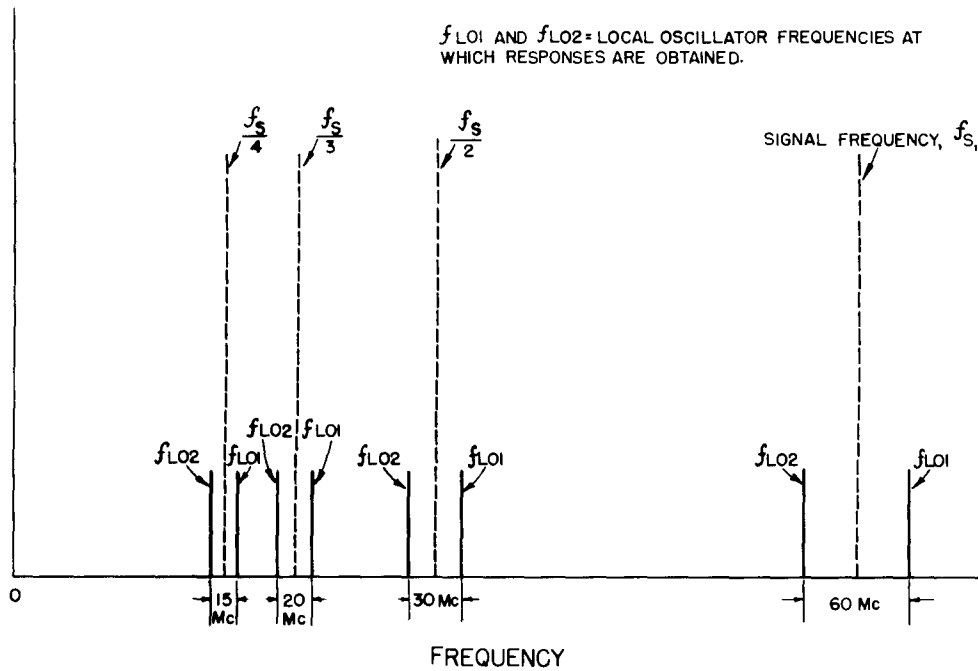

Figure 12. Chart showing local oscillator frequencies at which responses will be produced with various local oscillator harmonics.

TYPE 1216-A UNIT I-F AMPLIFIER

harmonic content of the signal applied to the detector may be greatly increased; in fact, the harmonics may be much larger than the fundamental. Care must be taken, therefore, particularly when the signal frequency is not accurately known, in setting the local oscillator to heterodyne with the fundamental and not with one of the harmonics. Except for null applications, the determination can usually be made easily by selecting the strongest signal. One of the best ways to eliminate this source of confusion, in the general case, is to install a low-pass filter between the source and the detector in order to reduce the harmonics to an insignificant value. The Type 874-F500, 500-Mc Low-Pass Filter and the Type 874-F1000, 1000-Mc Low-Pass Filter are well suited to this application.

The correct response can be identified, however, without the use of a filter. As shown in Figure 12, a 30-Mc difference frequency will be produced by beating of the fundamentals of the signal- and local-oscillator frequencies when the local-oscillator frequency is set 30 Mc above or below the signal frequency. Hence, two approximately equal amplitude responses are found at local-oscillator frequencies separated by 60 Mc.

If the signal frequency is approximately twice the local-oscillator frequency, a 30-Mc difference frequency will be produced when the second harmonic of the local oscillator is 30 Mc different in frequency from the signal. As shown in Figure 12, two approximately equal responses will be produced when the local-oscillator fundamental frequency is set

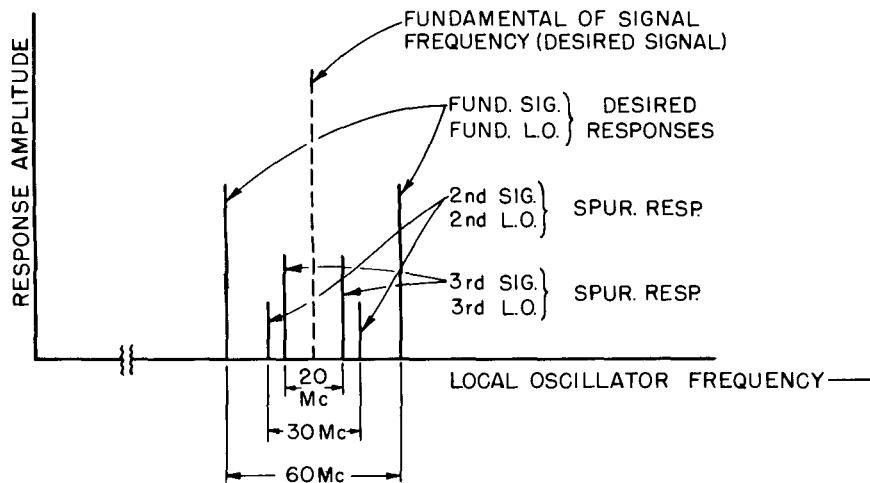

Figure 13. Possible responses in the vicinity of the signal frequency produced by harmonics of the local oscillator beating with harmonics of the same order of the signal frequency.

GENERAL RADIO COMPANY

15 Mc on either side of half of the signal frequency. Therefore, two responses at local-oscillator frequencies separated by 30 Mc will be produced.

If the signal frequency is approximately three times the local-oscillator frequency, two approximately equal amplitude responses will be found separated by 20 Mc. In general, a response will be found whenever the local oscillator is set to a frequency f_{LO} for a signal frequency f_s according to the expression:

$$f_{LO} = \frac{f_s \pm 30}{n} = \frac{f_s}{n} \pm \frac{30}{n} \quad \text{Mc} \quad (1)$$

where n is an integer equal to unity or more and actually is the harmonic of the local-oscillator signal used. Note that a pair of responses will be produced at local-oscillator frequencies around each submultiple of the signal frequency spaced by $\frac{60}{n}$ Mc.

As previously pointed out, the harmonic performance is not significantly dependent on harmonics generated in the local oscillator, but depends mainly on the non-linear characteristic of the crystal.

The actual signal frequency can be determined from the frequencies of a related pair of responses, using the following equation:

$$f_s = 30 \times \frac{f_{LO1} + f_{LO2}}{f_{LO1} - f_{LO2}} \quad (2)$$

When a signal with a significant harmonic content is introduced into the mixer, the situation can be more complicated, particularly if the harmonics are large compared to the fundamental as in the case of the null-detector application previously mentioned. Under normal conditions, when the harmonics are small, the correct response can be easily determined by choosing the response having the greatest magnitude.

In the general case, in which the harmonics may be larger than the fundamental, the responses shown in Figure 13 may be produced when the local oscillator is tuned over a frequency range in the vicinity of the fundamental of the signal frequency. Two responses 60 Mc apart will be produced by the fundamental of the local oscillator beating with the fundamental of the input signal; two other responses 30 Mc apart will be produced by the second harmonic of the local oscillator beating with the second harmonic of the input signal; two responses 20 Mc apart will be produced by the third harmonic of the local oscillator beating with the third harmonic of the input signal frequency; and so on for

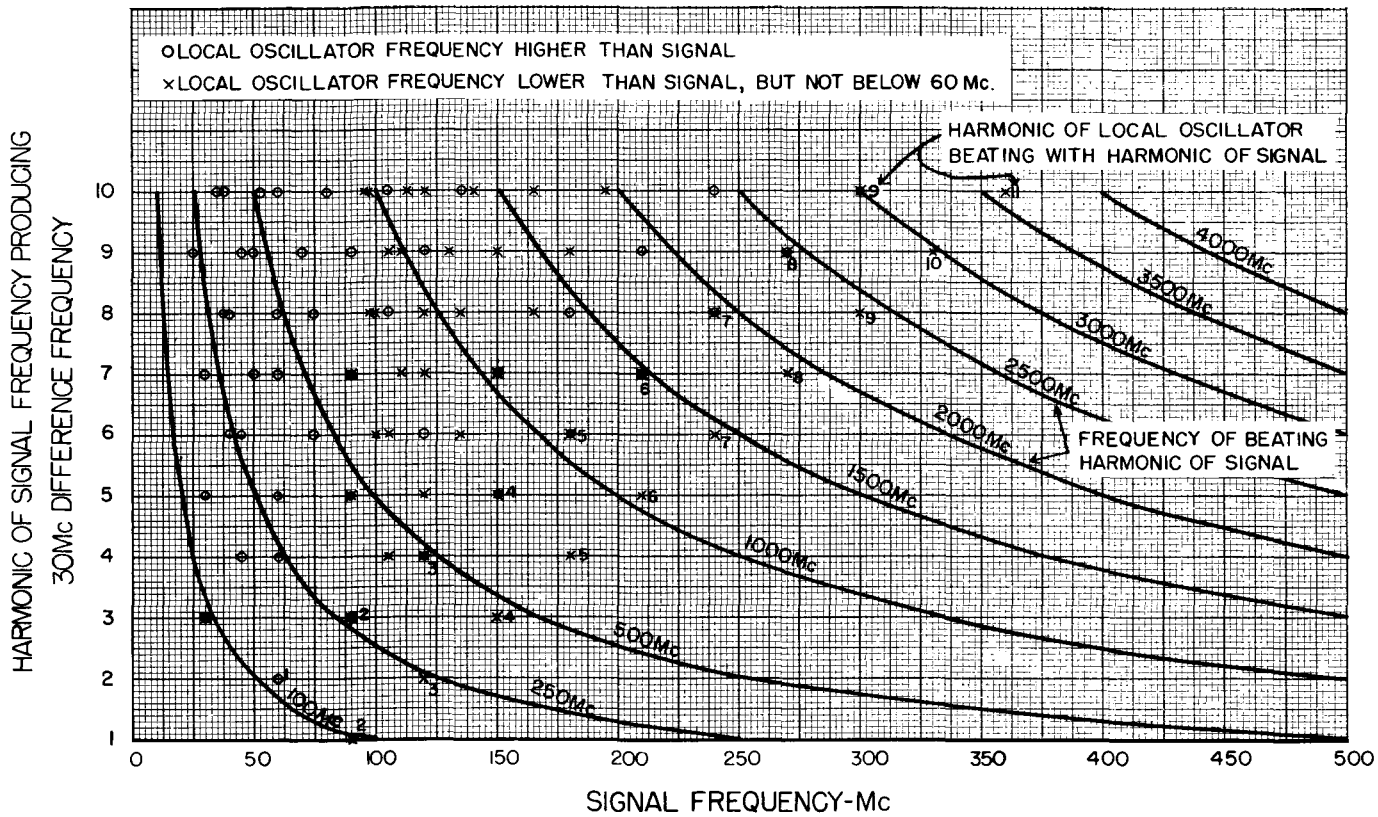

Figure 14. Signal frequencies at which overlapping harmonic responses can be obtained as a result of harmonics of the signal frequency beating with different harmonics of the local-oscillator frequency and producing 30-Mc difference frequencies.

GENERAL RADIO COMPANY

higher harmonics. When the frequency is so high that the correct response cannot be definitely identified using Equation (1) owing to lack of a sufficiently accurate knowledge of the signal and local-oscillator frequencies, the frequencies of several responses in the vicinity of a local-oscillator setting should be noted, along with their amplitudes, in order to pick out pairs, and the signal frequency determined using Equation (2).

If the signal frequency is known, but large magnitude harmonics are present, the desired local-oscillator frequency can be calculated from Equation (1), and, at frequencies below 500 Mc, most oscillators are calibrated accurately enough to prevent confusion with undesired responses. At higher frequencies, it is usually a good plan to check for the companion response located 60 Mc away, to make sure that the frequency calibration is not sufficiently in error to cause confusion. Of course, the best solution is to install a Type 874-F1000, 1000-Mc Low-Pass Filter between the source and the detector.

In null-detector applications, in which a signal is balanced to a null, harmonics can also be troublesome at several specific frequencies at which, when the fundamental of the signal and local oscillator are 30 Mc apart, one harmonic of the signal and a different harmonic of the local oscillator are also 30 Mc apart. In this case, the detector will tune to both frequencies, although the harmonic sensitivity will be much below the fundamental sensitivity, and a residual signal will be produced which cannot be balanced out. The residual signal is usually small and is not usually a source of error (unless a non-linear unknown such as a crystal is being measured), but it can frequently be reduced in magnitude by tuning the oscillator to the high-frequency side of the signal. Of course, the insertion of a low-pass filter in either the generator or detector circuit will eliminate the residual signal.

The specific frequencies at which multiple responses can occur are plotted in Figure 14. Note that they mainly are important at the lower frequencies at integer multiples of 30 Mc. For instance, at a signal frequency of 120 Mc, with the local oscillator set to 90 Mc, the second harmonic of the signal at 240 Mc and the third harmonic of the local oscillator at 270 Mc will be 30 Mc apart. If the local oscillator is set on the high-frequency side of the signal at 150 Mc, the fourth harmonic of the signal at 480 Mc and the third harmonic of the local oscillator at 450 Mc, will be 30 Mc apart. With the oscillator on the high-frequency side of the signal, the spurious responses occur at higher frequencies than obtained with the local oscillator on the low-frequency side; hence, the amplitudes of the spurious responses are usually much smaller.

At 360 Mc, the lowest harmonic at which a multiple response is obtainable is the tenth or at 3600 Mc. The frequency of the first multiple response obtainable increases very rapidly with the signal frequency as shown in Figure 14, hence, the problem usually disappears rapidly as the frequency is raised.

TYPE 1216-A UNIT I-F AMPLIFIER

2.3 USE AS A GENERAL-PURPOSE DETECTOR

When the combination of the i-f amplifier, Mixer Rectifier and local oscillator is used as a general-purpose detector, the equipment is connected as shown in Figure 11. If maximum sensitivity is not required, the insertion of a Type 874-G10, 10-DB Pad or a Type 874-G20, 20-DB Pad between the signal source and the mixer input is recommended to minimize fluctuations of the local-oscillator voltage applied to the crystal (see Section 2.1) and to improve the input VSWR. If difficulty is encountered from harmonics of the signal or other spurious high-frequency signals, a Type 874-F500, 500-Mc Low-Pass Filter or Type 874-F1000, 1000-Mc Low-Pass Filter can be inserted between the signal source and the Mixer Rectifier. If a pad is used, the filter can be inserted on either side of the pad. However, if the minimum VSWR is desired, the filter should be inserted between the pad and the Mixer Rectifier. (See Section 2.1.)

The signal source then is connected to the detector input and the local oscillator tuned to a frequency 30 Mc above or below the signal frequency for fundamental operation (for harmonic operation, see Section 2.2). With the attenuator switch set to AVC ON, search with the local oscillator over a small frequency band in the vicinity of the calculated frequency for the response and tune to the peak response. Throw the METER READS switch momentarily to D-C MIXER CURRENT and check that the meter indication is between 5% and 100% of full scale. If it is not, adjust the local-oscillator output until it is. (At some frequencies, if a pad is not used, the signal circuit may produce a very low impedance in parallel with the crystal at the local-oscillator frequency and very little local-oscillator voltage will be developed across the crystal. As a result, very little mixer current will be produced. In this case, if a maximum sensitivity is not required, a pad can be added which increases the impedance to 50 ohms. If maximum sensitivity is required, and the rectified current must be increased, a short length of line, such as a Type 874-L10 Air Line or a Type 874-EL Ell can be inserted between the mixer and the signal source, or other methods can be used to increase the impedance seen looking toward the signal source. See Section 2.1.)

The meter reading obtained with the METER READS switch set to I-F OUTPUT is an indication of the relative signal level unless the input signal is pulsed. In the pulsed case, the meter reading may be negligible even for signals which overload the amplifier because the meter responds to the average signal level, not to the peak level. (See Fig. 9A.)

With normal c-w or sine-wave modulated signals, the meter reading will be approximately logarithmic with the AVC ON. A linear relationship is obtained if the ATTENUATOR is set to any position other than AVC ON. At very small meter deflections, the meter departs from its linear response due to contact potential and noise (see Section 1.22

GENERAL RADIO COMPANY

and Figure 9). A decibel scale, which can be used to interpolate between steps of the attenuator, is also provided on the meter.

In order to measure the relative difference in two signal levels at the same frequency, the step ATTENUATOR should be adjusted until the meter reads in the calibrated DECIBELS portion of the scale. (For maximum accuracy, peak the response by a slight retuning of the local oscillator.) Then add the meter DECIBELS scale reading and the step ATTENUATOR setting, and obtain A_1 . Then, change the signal level to the value to be compared and, if necessary, reset the step ATTENUATOR to bring the meter pointer on the calibrated portion of the DECIBELS scale. Add the meter and ATTENUATOR readings, and obtain A_2 . (Make sure that the signal frequency did not shift significantly when the signal level was changed by checking the local-oscillator peaking.)

The ratio of the two signal levels, $\frac{V_1}{V_2}$, expressed in decibels is equal to the difference in the decibel values previously obtained.

$$\frac{V_1}{V_2} = A_1 - A_2 \text{ decibels}$$

When the input signal is modulated, a voltage corresponding to the modulation envelope is available at the binding posts on the panel. The over-all effective video bandwidth is approximately 0.350 Mc; hence a rise time of 1.4 μ s can be obtained. The peak output voltage is 2 volts and the output impedance is 600 ohms. (See page 11 and Figure 9A.)

2.4 USE AS A NULL DETECTOR

The combination of the i-f amplifier, a Type 874-MR Mixer Rectifier, and a Unit Oscillator is well suited for use as a null detector with impedance-measuring devices such as the Type 1602 U-H-F Admittance Meter. This combination is referred to as a Type DNT Detector; a typical measurement setup is shown in Figure 15. This type of detector has high sensitivity, is very well shielded, and is small and can be transported easily. For the best shielding, the Mixer Rectifier should be mounted directly on the admittance meter. It is usually convenient to use a Type 874-EL Ell, as shown in Figure 15, to route the oscillator cable away from the front of the admittance meter. The newer, smaller Type 874-R22 Connecting Cable is recommended for interconnections because of its greater flexibility rather than the older, larger Type 874-R20 Connecting Cable.

The use of a Type 874-F500, 500-Mc Low-Pass Filter or Type 874-F1000, 1000-Mc Low-Pass Filter between the generator supplying the admittance meter and the admittance meter is recommended, particularly at frequencies above 500 Mc, to eliminate confusion resulting from spurious harmonic responses described in Section 2.2. In null-

TYPE 1216-A UNIT I-F AMPLIFIER

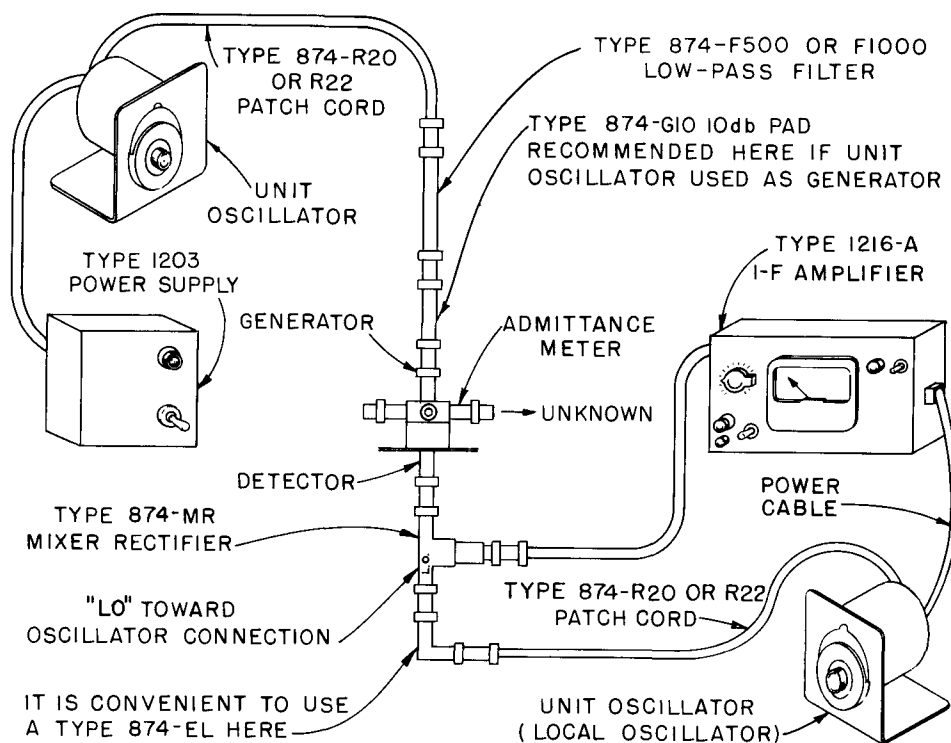

Figure 15. Diagram of a typical setup for measuring admittance, impedance, or VSWR using the Type 1602 Admittance Meter, a Unit Oscillator, and a Type DNT Detector Assembly.

detector applications, the harmonic content of the signal can be increased many orders of magnitude since the instrument may be very close to balance at the fundamental frequency but far from balance at the harmonic frequency.

In some cases, it may be found that it is not possible to balance the instrument to produce a complete null. Of course, a small residual meter deflection is always produced by contact potential in the second detector and by the noise which is the normal residual signal. A larger than normal residual signal may be caused by: (1) an excessive local-oscillator voltage applied to the crystal; (2) an extraneous 30-Mc signal being picked up by the circuit under test; (3) an extraneous r-f signal picked up by the circuit under test, which beats with the fundamental or a harmonic of the local oscillator and produces a 30-Mc difference-frequency signal; or (4) a harmonic of the signal frequency, which beats with a different harmonic of the signal frequency to produce a 30-Mc difference frequency.

GENERAL RADIO COMPANY

The first source of difficulty can be easily checked by switching the meter on the i-f amplifier to read the rectified mixer current. Less than a full-scale reading should be produced. The second possible source of difficulty can be checked by turning off both the oscillator used to drive the impedance-measuring device and the local oscillator. If the 30-Mc signal is of external origin, it will not disappear. The third possible source can be checked by turning off only the oscillator used to drive the impedance-measuring device. The fourth possible source of difficulty is explained in the last part of Section 2.2 and in Figure 14, and can be checked by shifting the oscillator to the opposite side of the signal frequency or inserting an appropriate low-pass filter.

The steps in actual operation are as follows:

1. Connect the units as shown in Figure 15. The ATTENUATOR switch should be set to AVC ON and the METER READS switch to I-F OUTPUT. Set the Admittance Meter to a greatly unbalanced condition in order to minimize the relative harmonic output (CONDUCTANCE arm at 20, MULTIPLYING FACTOR arm at ∞ , and SUSCEPTANCE arm at zero).
2. Calculate the local-oscillator frequency at which a response will be obtained. For fundamental operation, this is 30 Mc above or below the signal frequency. For harmonic operation of the oscillator, use Equation (1).
3. Set the local oscillator to the desired frequency and throw the METER READS switch to D-C MIXER CURRENT. The meter indication should be between 5% and 100% of full scale. If it is not, adjust the local-oscillator output, or add a section of Type 874-L10 Air Line between the Admittance Meter and the Mixer Rectifier to change the impedance shunting the crystal as seen by the local oscillator. (Lower meter readings can be tolerated if the sensitivity obtained is adequate.)
4. Throw the METER READS switch back to I-F OUTPUT, and retune the local oscillator slightly to obtain a maximum meter deflection.
5. If the frequency is high, or if a local-oscillator harmonic is used, the companion response having approximately equal amplitude should be located on the opposite side of the signal frequency, or submultiple thereof, to make sure the desired signal, and not a harmonic thereof, is being detected. (See Section 2.2.) On fundamental operation, the separation between companion responses is 60 Mc. On second-harmonic operation of the local oscillator, the separation between companion responses is 30 Mc.
6. The device is now ready for use. Balance the measuring instrument for a minimum meter deflection. A zero reading will not be obtained because the noise generated in the mixer and first amplifier

TYPE 1216-A UNIT I-F AMPLIFIER

stage will produce approximately a 10% deflection. A very large residual meter reading may be caused by excessive local-oscillator voltage applied to the crystal, or by an extraneous r-f signal at the signal frequency, or at other image or harmonic frequencies to which the detector will respond, or at the 30-Mc intermediate frequency. (See paragraph immediately preceding Step 1.

2.5 USE AS A VSWR INDICATOR AND IN MEASUREMENT OF IMPEDANCE MAGNITUDE WITH THE ADMITTANCE METER

The calibrated attenuator makes it possible to use the combination outlined in Section 2.4 to measure reflection coefficient or VSWR and to compare impedance magnitude by voltage-ratio methods. These methods are outlined in detail in the Operating Instructions for the Type 1602 Admittance Meter.

The steps in the comparison of two signal levels are as follows:

1. Set up the equipment and find the proper response as outlined in Section 2.4. The D-C MIXER CURRENT should read between 5% and 100% of full scale for maximum accuracy at high attenuator settings when the fundamental of the local oscillator is used.

2. With one signal level being applied, adjust the step ATTENUATOR until the meter reads on the calibrated DECIBELS scale. Check the tuning of the local oscillator to make sure that the response is peaked. Then, add the meter reading and the ATTENUATOR setting and obtain A_1 .

3. Make the necessary readjustments in the Admittance Meter, and again readjust the step ATTENUATOR until the meter reads on the calibrated portion of the scale. Add the meter reading to the step ATTENUATOR setting, and obtain A_2 .

4. The difference in signal level in db is equal to the difference in the two readings.

$$\frac{V_1}{V_2} = A_1 - A_2 \text{ decibels}$$

2.6 USE AS A VSWR INDICATOR FOR SLOTTED LINES

The detector is well suited for use as a detector for slotted lines because it has high sensitivity, good linearity, excellent shielding, and excellent harmonic rejection. It can be mounted directly on the moving carriage of the slotted line, or can be connected to the probe in the carriage by means of a double-shielded coaxial cable. The new Type 874-R22 Patch Cord is convenient to use for the coaxial connecting cables in

GENERAL RADIO COMPANY

either type of mounting because of its good shielding, small diameter, and flexibility.

The detector is operated as outlined in Section 2.3.

2.7 USE IN CALIBRATING R-F ATTENUATORS

High-frequency attenuators can be accurately calibrated or checked, with the attenuator in the i-f amplifier used as a standard.

If the attenuator is a variable type and is part of a signal generator, in which case it is driven by an internal oscillator, the detector should be set up as outlined in Section 2.3, and a 10- or 20-db pad, having a characteristic impedance equal to the output impedance of the attenuator, should be connected between the mixer and the attenuator output. Type 874-G10 and -G20 Pads can be used if the impedance is 50 ohms. For other impedances, a pad can be constructed, or a length of coaxial cable having about 10 to 20 db of attenuation at the operating frequency can be used.

The detector should be tuned to the proper frequency, as outlined in Section 2.3. The attenuator under test should then be set at its maximum output, and the step ATTENUATOR in the amplifier adjusted to obtain a meter indication in the calibrated DECIBELS portion of the scale. The local-oscillator frequency should be adjusted for a peak meter reading, and the sum, A_1 , of ATTENUATOR and meter DECIBELS scale readings obtained. The attenuator under test should then be set to another position and the ATTENUATOR readjusted, if necessary, to bring the meter indication in the DECIBELS portion of the scale. The sum, A_2 , of ATTENUATOR and meter DECIBELS scale readings is then obtained. The actual attenuation between the steps of the attenuator under test is equal to $A_1 - A_2$.

The local-oscillator tuning should be checked to make sure that neither oscillator has shifted during the measurement, and for maximum accuracy, the original reading should be rechecked. Repeat the above procedure for all the desired attenuator steps.

If the attenuator is a separate unit and the absolute value of insertion loss is desired, a signal generator, oscillator (the Type 1215, 1208, 1209, and 1218 Unit Oscillators are satisfactory for this purpose), or other source of r-f power is used to drive the attenuator. If the oscillator does not have an output impedance equal to the characteristic impedance of the attenuator, use a 10- or 20-db pad of the correct impedance to obtain the desired source impedance. (See preceding paragraphs.) The mixer should also be fitted with a 10- or 20-db pad of the correct impedance as outlined in the previous paragraphs. The maximum possible error in insertion loss caused by an imperfectly matched source or detector is plotted in Figure 16. The attenuator under test is

TYPE 1216-A UNIT I-F AMPLIFIER

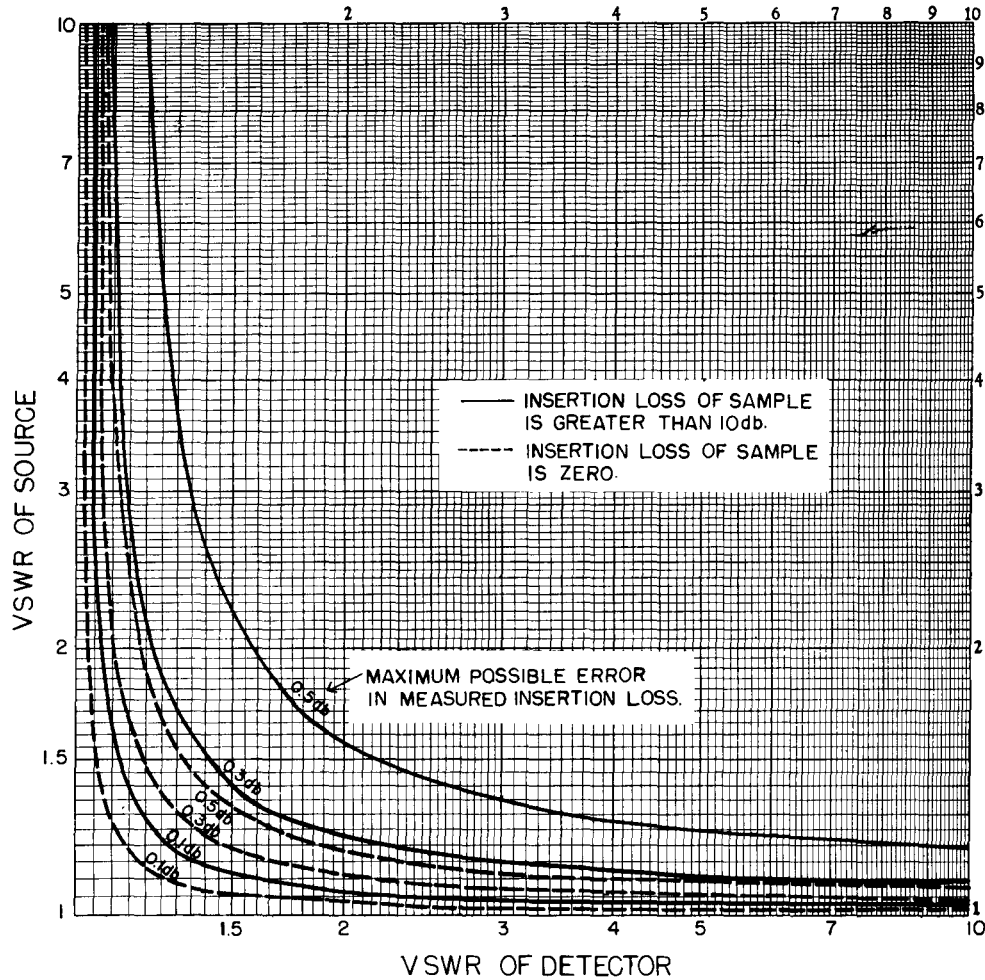

Figure 16. Maximum possible error in insertion loss measured by the substitution method caused by mismatching of the detector and generator. Sets of curves are given for maximum possible errors when the measured attenuation is large (greater than 10 db) and when the measured attenuation is zero. For circuits having insertion losses between zero and 10 db, the maximum possible errors can be estimated by interpolation on the chart. These figures assume that the input and output impedances of the unknown are equal to the characteristic impedance. If they are different, a small additional error is possible.

GENERAL RADIO COMPANY

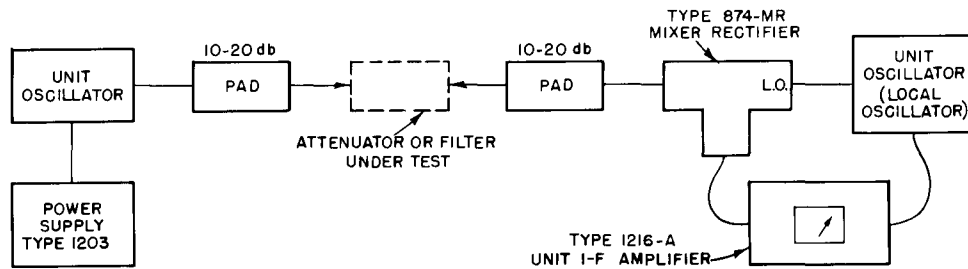

Figure 17. Block diagram of setup for measuring the insertion loss of attenuators or filters. In some cases it may be desirable to insert a low-pass filter between the oscillator and pad to minimize spurious responses.

connected between the generator and detector as shown in Figure 17, and the unit is adjusted as outlined in Section 2.2. The ATTENUATOR is adjusted to produce a meter reading within the calibrated DECIBELS portion of the meter scale, the local-oscillator frequency slightly readjusted for peak response, and the sum of the ATTENUATOR and DECIBELS meter scale reading obtained.

The attenuator under test is then removed and the generator and detector connected directly together. (The attenuator alone should be removed. Do not remove the pads.) The ATTENUATOR is then adjusted, if necessary, to produce a meter reading within the calibrated DECIBELS portion of the scale, and the sum of the ATTENUATOR and meter DECIBELS scale readings obtained. The insertion loss of the unknown in decibels is equal to the difference in the sums obtained in the two measurements. If maximum accuracy is desired, the local-oscillator tuning should be checked for frequency drift, and the original ATTENUATOR and meter reading, with the attenuator in place, rechecked. Also if the mixer is not isolated from the circuit under test by at least a 10-db pad, the change in impedance seen by the local-oscillator signal when the unknown is removed may change the local-oscillator voltage appearing across the mixer diode. This change in voltage may affect the rectification efficiency and the load impedance seen by the signal being detected and hence cause an error. To eliminate this error, more padding can be used or the local-oscillator input changed to maintain the d-c mixer current at a constant level.

The range of insertion loss measurable depends upon the power output of the oscillator used as well as on the range of the attenuator in the i-f amplifier. If adequate oscillator power is available, the range of measurement can be extended to more than 80 db by inserting Type 874-G20,20-DB Pads in place of the attenuator under test (only during measurement with the unknown attenuator removed; the pads must be removed when the attenuator under test is connected). The actual insertion loss is then the measured loss plus the attenuation of the additional pads inserted. With the Unit Oscillators, insertion loss ranges of approximately 100 db can be measured using this method.

TYPE 1216-A UNIT I-F AMPLIFIER

If a well-calibrated signal generator is available, its attenuator can be used in place of the attenuator in the i-f amplifier, and the detector then used as a sensitive, uncalibrated indicator to determine reference levels. The excellent shielding and sensitivity of the detector make it well suited for this application. The source and output impedances must be matched as described above. With the circuit under test inserted between the signal generator and the detector, the detector should be set up as previously described, and the attenuator in the signal generator set to produce a full-scale meter deflection on the amplifier with the ATTENUATOR on the amplifier set between 0 and 20 db. The circuit under test is then removed, and the attenuator on the generator reset to produce the same full-scale meter reading. The difference in the outputs indicated by the attenuator in the signal generator is equal to the insertion loss of the circuit under test.

2.8 USE IN MEASURING ATTENUATION OF COAXIAL CABLES

The attenuation of coaxial cables can be rapidly and accurately measured over a wide frequency range using either of the methods described in Section 2.7. If 50-ohm cables are measured, the Type 874-G10 and -G20 Pads can be used to make the source and load impedances look like 50 ohms. (See Figure 17.) If the cable impedance is not 50 ohms, lengths of cable, similar to the type under test, having an over-all attenuation of from 10 to 20 db at the frequency of the test, can be used as pads.

2.9 USE IN MEASURING FILTER CHARACTERISTICS

Filters can be accurately measured over a wide frequency range using the substitution method described for attenuators in Section 2.7. A typical set up is shown in Figure 18.

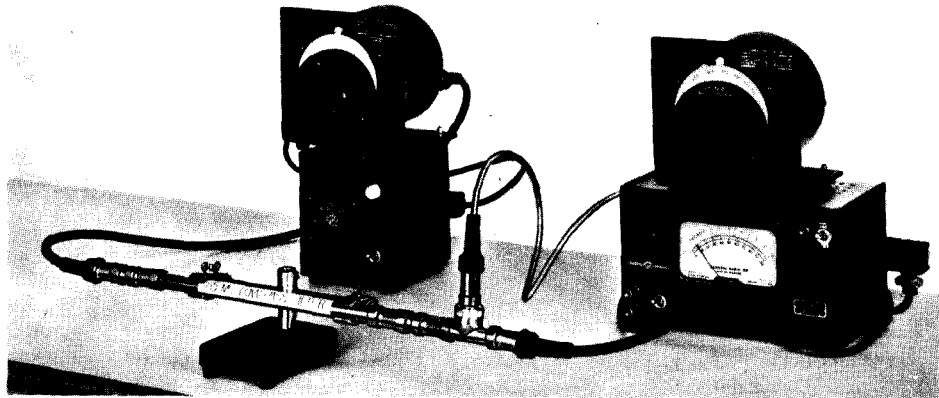

Figure 18. View of the Type DNT-1 Detector Assembly and a Type 1208 Unit Oscillator set up for insertion-loss measurements on a 185-megacycle low-pass filter.

GENERAL RADIO COMPANY

2.10 USE IN MEASURING CROSSTALK IN COAXIAL SWITCHES

Very small amounts of crosstalk can be accurately measured over a wide frequency range using the substitution method described in Section 2.7. In this case, the input to the switch is connected to an oscillator having the required output impedance, the detector with proper pads is connected to one of the coaxial output connectors, and a termination unit having the same characteristic impedance as the coaxial line in the switch (a Type 874-WM 50-Ohm Termination for 50-ohm lines) is connected to the other coaxial output connector. The detector is set up as outlined in Section 2.2.

The crosstalk can be measured in two ways. The most accurate method is to obtain the sum of the ATTENUATOR and DECIBELS scale readings with the detector connected as just described, then interchange the termination and the detector, and again find the sum of the ATTENUATOR and DECIBELS scale readings. The difference in these two sums is equal to the crosstalk in decibels.

In the second method, which is sufficiently accurate for most practical applications, the detector is not moved, but the coaxial switch is thrown from one position to another and the difference in the decibel sums determined. This difference is approximately equal to the crosstalk.

2.11 USE IN MEASURING ANTENNA PATTERNS AND GAIN

Antenna patterns⁶ can be measured over the V-H-F and U-H-F bands with the detector and a Unit Oscillator. A Unit Oscillator is used to drive one antenna, and the detector is used to measure the relative voltage induced in a second antenna. One of these antennas is the unit under test and the second is a monitoring antenna. In order to obtain the horizontal pattern, the antenna under test is rotated and the relative output of the monitoring antenna measured as a function of the angle of rotation. The sum of the ATTENUATOR and meter DECIBELS scale readings, at any antenna setting, is proportional to the field intensity. If the antennas are balanced, Type 874-UB Baluns should be used between the coaxial systems and the balanced systems.

Care must be taken to prevent reflections from interfering with measurements. A highly directional monitoring antenna is helpful in eliminating the effects of reflections. Radiation from cables, power cords, etc. must be eliminated for the most accurate results.

For antenna gain measurement,⁷ the antenna under test is connected to a detector having an input impedance equal to the impedance

⁶F. E. Terman and J. M. Pettit, "Electronic Measurements", Second Edition, p. 415, McGraw-Hill Book Company, New York, 1952.

⁷F. E. Terman and J. M. Pettit, loc. cit., p. 433.

TYPE 1216-A UNIT I-F AMPLIFIER

for which the antenna was designed. The monitoring antenna is driven from an oscillator. The relative antenna output under these conditions is determined as outlined in the preceding paragraph. The antenna under test is then replaced by a standard dipole (a standard folded dipole for television receiving-antenna applications⁸), and the relative output again determined. The difference in the relative outputs is the gain of the antenna. The relative outputs can be easily measured using a Type DNT Detector and a Unit Oscillator with appropriate pads.

If the antenna system is a 300-ohm balanced line system, a Type 874-UB Balun with a Type 874-P3 300-Ohm Terminal Pad can be used between the coaxial system and the balanced-line system. A 10- or 20-db pad is still required between the Mixer Rectifier and the balun to produce the desired input impedance.

2.12 USE IN MEASURING FIELD STRENGTH

The power output of a standard antenna^{9,10} into a known impedance can be measured using the Type DNT Detector in combination with a voltmeter, bolometer, signal generator, or other device for calibrating the detector at one signal level; hence, the field strength can be calculated. The mixer is connected to the standard antenna through a 20-db pad having the correct impedance. (For 50-ohm impedances, a Type 874-G20,20-DB Pad can be used. For 300-ohm balanced impedances, the 20-db pad, with a Type 874-UB Balun equipped with a Type 874-UB-P3 300-Ohm Terminal Pad, can be used.)

The detector is set up as outlined in Section 2.2, and the sum of the ATTENUATOR and meter DECIBELS scale reading is obtained. The power input corresponding to this reading can be obtained by several methods:

1. The detector input, with its pad but without the balun, can be connected to a signal generator, and the attenuator in the generator set to produce a meter reading equal to that obtained with the antenna connected. The input power to the detector can then be calculated from the signal-generator output.
2. The detector can be calibrated as above but at any arbitrary level. The actual power input from the antenna can be determined from the reference power input, using the db difference in level measured on the detector.

⁸RETMA Standards REC-141 (March, 1954).

⁹F. E. Terman and J. M. Pettit, loc. cit., p. 448.

¹⁰D. D. King, "Two Standard Field-Strength Meters for Very High Frequencies", Proc. IRE, Vol. 38, p. 1048, September, 1950.

GENERAL RADIO COMPANY

3. An uncalibrated oscillator, such as a Unit Oscillator, and an r-f power-measuring device can be used in place of the signal generator to supply the calibration voltage. The power output of the oscillator with a 10- or 20-db pad connected is measured. The oscillator is then connected to the input of the detector, and the ATTENUATOR is set to produce an on-scale meter reading. The power input at this level is the same as that measured initially. The power input from the antenna is less than the calibration power by the db difference in the detector indication. If the power input from the oscillator produces an input beyond the range of the attenuator in the i-f amplifier, additional Type 874-G20 20-DB Pads can be inserted to reduce the input by known amounts.

In any of the preceding methods, if the balun is used with the Type 874-UB-P3, 300-ohm Terminal Pad, the indicated power output of the antenna should be multiplied by 1.5 to account for the effect of the two 50-ohm resistors in series with the balanced line.

The relationship between field strength, E , in volts/meter and power output in watts, P_T , for a very thin dipole is as follows:

$$E \approx \frac{53.8}{\lambda} \sqrt{P_T} \quad \text{volts/meter}$$

where λ is the wavelength in meters.

2.13 LOW-LEVEL VOLTMETER APPLICATIONS

As outlined in Section 2.12, the absolute voltage or power level corresponding to a certain indicated signal level can be determined by calibrating the detector at a single signal level, using a power-measuring device or by comparison with a signal having a known voltage, such as the signal produced by a signal generator. In this way, the Type DNT Detector can be used to measure voltages as low as 10 μv with a reasonable degree of accuracy. If a pad is not used ahead of the Mixer Rectifier, the source impedance of the calibrating source and the output impedance of the unknown voltage source as seen at the Mixer Rectifier must be the same.

2.14 USE AS A WAVE ANALYZER

The Type DNT Detector has limited use as a wave analyzer. It has a high degree of selectivity except at image frequencies and at frequencies at which the harmonics of the local oscillator produce a response (see Section 2.2). Also, for large signals, harmonics of the signal frequency are generated in the mixer. Figure 19 shows the relative amplitude of the harmonics generated as a function of the signal level. The harmonic percentages indicated are the thresholds of measurement at various signal levels.

TYPE 1216-A UNIT I-F AMPLIFIER

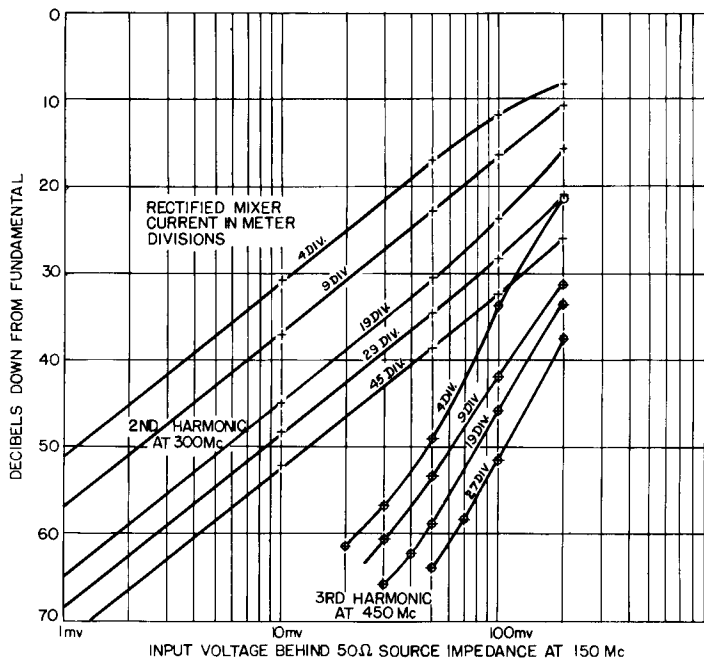

Figure 19. Curves showing the relative amplitudes of harmonics generated in the mixer as a function of the fundamental signal-voltage level for various local-oscillator excitations.

In general, if the harmonic content of the signal to be analyzed is large, measurements can be made of the harmonic content. For the best results, the signal level should be kept as low as possible and a filter added ahead of the mixer.

SECTION 3.0 SERVICE AND MAINTENANCE

3.1 GENERAL

The two-year warranty given with every General Radio instrument attests the quality of materials and workmanship in our products. When difficulties do occur, our service engineers will assist in any way possible.

In case of difficulties that cannot be eliminated by the use of these service instructions, please write or phone our Service Department, giving full information of the trouble and of steps taken to remedy it. Be sure to mention the serial and type numbers of the instrument.

Before returning an instrument to General Radio for service, please write to our Service Department or nearest district office (see back cover), requesting a Returned Material Tag. Use of this tag will ensure proper handling and identification. For instruments not covered by the warranty, a purchase order should be forwarded to avoid unnecessary delay.

GENERAL RADIO COMPANY

3.2 RETUNING AMPLIFIER PEAKING

The interstage peaking coils can be retuned by applying a 30-Mc signal into the input of the amplifier and adjusting the iron core penetration by means of the studs projecting from the top of the chassis and the back of the attenuator box until the meter indication is peaked. The lock nuts on these studs should first be loosened. The attenuator should be set at 30 db or more for this adjustment to prevent interaction of the tuned circuits at either end of the attenuator. The final adjustment of the input coil should be made from a 400-ohm source or with the 30-Mc signal generated in the Type 874-MR Mixer Rectifier by beating two high-frequency signals. The latter method is the best as it actually is the normal operating condition.

The last coil, which tunes the second detector stage, should not necessarily be adjusted for peak response. Better linearity of the meter scale can sometimes be obtained if the coil is offset slightly from the peak. With a 30-Mc input and with the earlier stages peaked, adjust the input to produce a full-scale meter indication. Then increase the attenuation in the step attenuator by 10 db and observe whether the meter reads 0 db. If it does not, readjust the tuning of the last coil slightly and repeat the procedure.

After the tuning adjustments have been completed, the studs attached to the iron cores should be locked in place by means of the lock nuts provided.

3.3 TUBE VOLTAGE CHART

The following chart shows the voltages measured between various pins on the tube sockets and ground, using a 20,000-ohm-per-volt voltmeter. The attenuator should be set at 30 db or above, and, if necessary, the i-f strip should be partially shielded to prevent oscillation.

	Type	Socket Pin Number								
		#1	#2	#3	#4	#5	#6	#7	#8	#9
V-1	6AK5	0	0.97	6.0 v. ac	0	107	98	0.97		
V-2	6CB6	0	2.5	6.1 v. ac	0	115	98	0		
V-3	6CB6	0	2.2	6.3 v. ac	0	122	100	0		
V-4	6U8	130	0	104	6.4 v. ac	0	130	1.17	2.7	0
V-5	6AL5	0	0	0	6.4 v. ac	0.25	0	-0.32		
V-6	OB2	104	0			105				

TYPE 1216-A UNIT I-F AMPLIFIER

3.4 CRYSTAL CHECK

The Type 1N21B crystal in the Type 874-MR Mixer Rectifier can be checked using an ordinary volt-ohmmeter set to the x100 resistance scale. Disconnect all leads to the mixer, and connect one of the ohm-meter leads to the center conductor of the i-f output connector. Connect the other lead to the center conductor of the signal input connector (the opposite end from the engraved L.O.) and measure the resistance. Then, reverse the leads. The resistance in one case should be between 100 and 600 ohms, and in the other case it should be greater than 15,000 ohms. If the crystal resistances are substantially outside of these limits, replace the crystal.

3.5 TUBE REPLACEMENT

The peaking coils associated with the plate and grid circuits of a replacement tube should be re-peaked, as outlined in Section 3.1, when a tube is replaced. Some Type 6CB6 tubes, when used in the second amplifier stage (V-2), may not exhibit a sufficient AVC range. If this is the case, use a different tube or exchange V-2 and V-3.

Parts List

RESISTORS:

R-1	=	47	Ohms	± 10%	REC-20BF
R-2	=	47	Ohms	± 10%	REC-20BF
R-3	=	8.2	K Ohms	± 5%	REC-20BF
R-4	=	120	Ohms	± 5%	REC-20BF
R-5	=	10	Ohms	± 10%	REC-20BF
R-6	=	470	Ohms	± 10%	REC-20BF
R-7	=	62	Ohms	± 5%	REC-20BF
R-8	=	147.0	Ohms	± 1%	REF-435-C1
R-9	=	65.8	Ohms	± 1%	REF-435 C1
R-10	=	142.3	Ohms	± 1%	REF-435 C1
R-11	=	96.2	Ohms	± 1%	REF-435 C1
R-12	=	142.3	Ohms	± 1%	REF-435 C1
R-13	=	96.2	Ohms	± 1%	REF-435 C1
R-14	=	96.2	Ohms	± 1%	REF-435 C1
R-15	=	142.3	Ohms	± 1%	REF-435 C1
R-16	=	96.2	Ohms	± 1%	REF-435 C1
R-17	=	147	Ohms	± 1%	REF-435 C1
R-18	=	292.1	Ohms	± 1%	REF-435 C1
R-19	=	17.63	Ohms	± 1%	REF-435 C1
R-20	=	292.1	Ohms	± 1%	REF-435 C1
R-21	=	96.2	Ohms	± 1%	REF-435 C1
R-22	=	71.1	Ohms	± 1%	REF-435 C1
R-23	=	96.2	Ohms	± 1%	REF-435 C1
R-24	=	86.8	Ohms	± 1%	REF-435 C1

GENERAL RADIO COMPANY

Parts List (Continued)

R-25	=	245.0	Ohms	± 1%	REF-435 C1
R-26	=	59.76	Ohms	± 1%	REF-435 C1
R-27	=	33	Ohms	± 5%	REC-20BF
R-28	=	470	Ohms	±10%	REC-20BF
R-29	=	470	Ohms	±10%	REC-20BF
R-30	=	10	Ohms	±10%	REC-20BF
R-31	=	47	Ohms	± 5%	REC-20BF
R-32	=	220	Ohms	±10%	REC-20BF
R-33	=	10	K Ohms	±10%	REC-20BF
R-34	=	10	K Ohms	±10%	REC-20BF
R-35	=	4.7	K Ohms	±10%	REC-20BF
R-36	=	1	Megohms	±10%	REC-20BF
R-37	=	4.7	K Ohms	±10%	REC-20BF
R-38	=	470	Ohms	±10%	REC-20BF
R-39	=	470	Ohms	±10%	REC-20BF
R-40	=	27	K Ohms	± 5%	REC-20BF
R-41	=	10	Ohms	±10%	REC-20BF
R-42	=	100	K Ohms	±10%	REC-20BF
R-43	=	470	Ohms	±10%	REC-20BF
R-44	=	470	Ohms	±10%	REC-20BF
R-45	=	220	Ohms	±10%	REC-20BF
R-46	=	270	Ohms	±10%	REC-20BF
R-47	=	120	Ohms	±10%	REC-20BF
R-48	=	27	K Ohms	± 5%	REC-20BF
R-49	=	10	Ohms	±10%	REC-20BF
R-50	=	100	K Ohms	±10%	REC-20BF
R-51	=	180	Ohms	± 5%	REC-20BF
R-52	=	470	Ohms	±10%	REC-20BF
R-53	=	470	Ohms	±10%	REC-20BF
R-54	=	270	Ohms	±10%	REC-20BF
R-55	=	100	K Ohms	±10%	REC-20BF
R-56	=	27	K Ohms	± 5%	REC-20BF
R-57	=	1	Megohm	± 5%	REC-20BF
R-58	=	330	Ohms	± 5%	REC-20BF
R-59	=	220	Ohms	±10%	REC-20BF
R-60	=	270*	Ohms	±5%	REC-20BF
R-61	=	51	Ohms	± 5%	REC-20BF
R-62	=	680	Ohms	± 5%	REC-41BF
R-63	=	680	Ohms	±10%	REC-41BF
R-64	=	3.3	K Ohms	± 5%	REC-41BF
R-65	=	820	Ohms	±10%	REC-41BF
R-66	=	820	Ohms	±10%	REC-41BF
*R-67	=	15	Ohms	±10%	REW-3C
R-68	=	470	Ohms	±10%	REC-20BF

* Part of P-1 Assembly

TYPE 1216-A UNIT I-F AMPLIFIER

Parts List (Continued)

R-69	=	4.7 K Ohms	±10%	REC-20BF
R-70	=	1 Megohms	±10%	REC-20BF
R-71	=	30 Ohms	±5%	REC-20BF
R-72	=	33 K Ohms	±5%	REC-20BF

CAPACITORS:

C-1	=	.0047 μ f	±20%	COC-62
C-2	=	.0047 μ f	±20%	COC-62
C-3	=	.001 μ f	(GMV) -0%	COC-3
C-4	=	.0047 μ f	±20%	COC-62
C-5	=	.0047 μ f	±20%	COC-62
C-6	=	.0047 μ f	±20%	COC-62
C-7	=	.001 μ f	(GMV) -0%	COC-3
C-8	=	560 μ f	±10% Max. Neg.	COC-21
C-9	=	.001 μ f	(GMV) -0%	COC-3
C-10	=	.001 μ f	(GMV) -0%	COC-3
C-11	=	.0047 μ f	±20%	COC-62
C-12	=	.001 μ f	(GMV) -0%	COC-3
C-13	=	.001 μ f	(GMV) -0%	COC-3
C-14	=	.0047 μ f	±20%	COC-62
C-15	=	.0047 μ f	±20%	COC-62
C-16	=	.0047 μ f	±20%	COC-62
C-17	=	.001 μ f	(GMV) -0%	COC-3
C-18	=	.0047 μ f	±20%	COC-62
C-19	=	.0047 μ f	±20%	COC-62
C-20	=	160 μ f	±10%	COM-20B
C-21	=	.0047 μ f	±20%	COC-62
C-22	=	.0047 μ f	±20%	COC-62
C-23	=	.0047 μ f	±20%	COC-62
C-24	=	160 μ f	±10%	COM-20B
C-25	=	.0047 μ f	±20%	COC-62
C-26	=	.0047 μ f	±20%	COC-62
C-27	=	.0047 μ f	±20%	COC-62
C-28	=	.0047 μ f	±20%	COC-62
C-29	=	10 μ f	±0.5 μ f NPO	COC-21
C-30	=	10 μ f	±0.5 μ f NPO	COC-21
C-31	=	.0047 μ f	±20%	COC-62
C-32	=	10 μ f	150 DCVV	COE-49
C-33	=	.0047 μ f	±20%	COC-62
C-34	=	.0047 μ f	±20%	COC-62
C-35	=	.0047 μ f	+100%-0%	COC-62
C-36	=	100 μ f	±10% Max. Neg.	COC-21
C-37	=	100 μ f	±10% Max. Neg.	COC-21
C-38	=	16 μ f	150 D.C. W.V.	COE-4
C-39	=	.0047 μ f	+100%-0%	COC-62

GENERAL RADIO COMPANY

Parts List (Continued)

C-40	=	.0047 μ f	+100%-0%	COC-62
C-41	=	.0047 μ f	+100%-0%	COC-62
C-42	=	.0047 μ f	+100%-0%	COC-62
C-43	=	.0022 μ f	+100%-0%	COC-62
C-44	=	.0022 μ f	+100%-0%	COC-62
C-45	=	40 μ f	250 D. C. W. V.	} Part of COEB-15
C-46	=	40 μ f	250 D. C. W. V.	
C-47	=	40 μ f	250 D. C. W. V.	
C-48	=	40 μ f	250 D. C. W. V.	
C-49	=	20 μ f	450 D. C. W. V.	} Part of COEB-25
C-50	=	20 μ f	450 D. C. W. V.	
C-51	=	20 μ f	450 D. C. W. V.	
C-52	=	20 μ f	450 D. C. W. V.	
C-53	=	.0047 μ f	\pm 20%	COC-62
C-54	=	.0047 μ f	\pm 20%	COC-62
C-55	=	.0047 μ f	\pm 20%	COC-62
C-56	=	.001 μ f	(6MV) - 0%	COC-3
C-57	=	.0047 μ f	\pm 20%	COC-62
C-58	=	.0047 μ f	\pm 20%	COC-62
C-59	=	.0047 μ f	\pm 20%	COC-62
C-60	=	.0047 μ f	\pm 20%	COC-62
C-61	=	.0047 μ f	\pm 20%	COC-62
C-62	=	0.1 μ f	\pm 10%	COW-17
C-63	=	.001 μ f	(6MV) - 0%	COC-3
C-64	=	.0047 μ f	\pm 20%	COC-62
C-65	=	.0047 μ f	\pm 20%	COC-62
C-66	=	560 μ f	\pm 10% Max. Neg.	COC-21
C-67	=	47C pf	\pm 20%	COC-60
C-68	=	.0047 μ f	\pm 20%	COC-62
C-69	=	.0047 μ f	\pm 20%	COC-62

INDUCTORS:

L-1	=	I. F. Coil Assembly	1216-201
L-2	=	I. F. Coil Assembly	1216-202
L-3	=	I. F. Coil Assembly	1216-203
L-4	=	I. F. Coil Assembly	1216-204
L-5	=	I. F. Coil Assembly	1216-205
L-6	=	I. F. Coil Assembly	1216-206
L-7	=		1216-210
L-8	=		1216-210
L-9	=	0.2 μ h	1216-209
L-10	=	1.75 μ h	ZCHA-17
L-11	=	7.6 μ h	ZCHA-19
L-12	=	7.6 μ h	ZCHA-19
L-13	=	7.6 μ h	ZCHA-19
L-14	=	1.75 μ h	1216-208
L-15	=		1216-210
L-16	=		1216-210

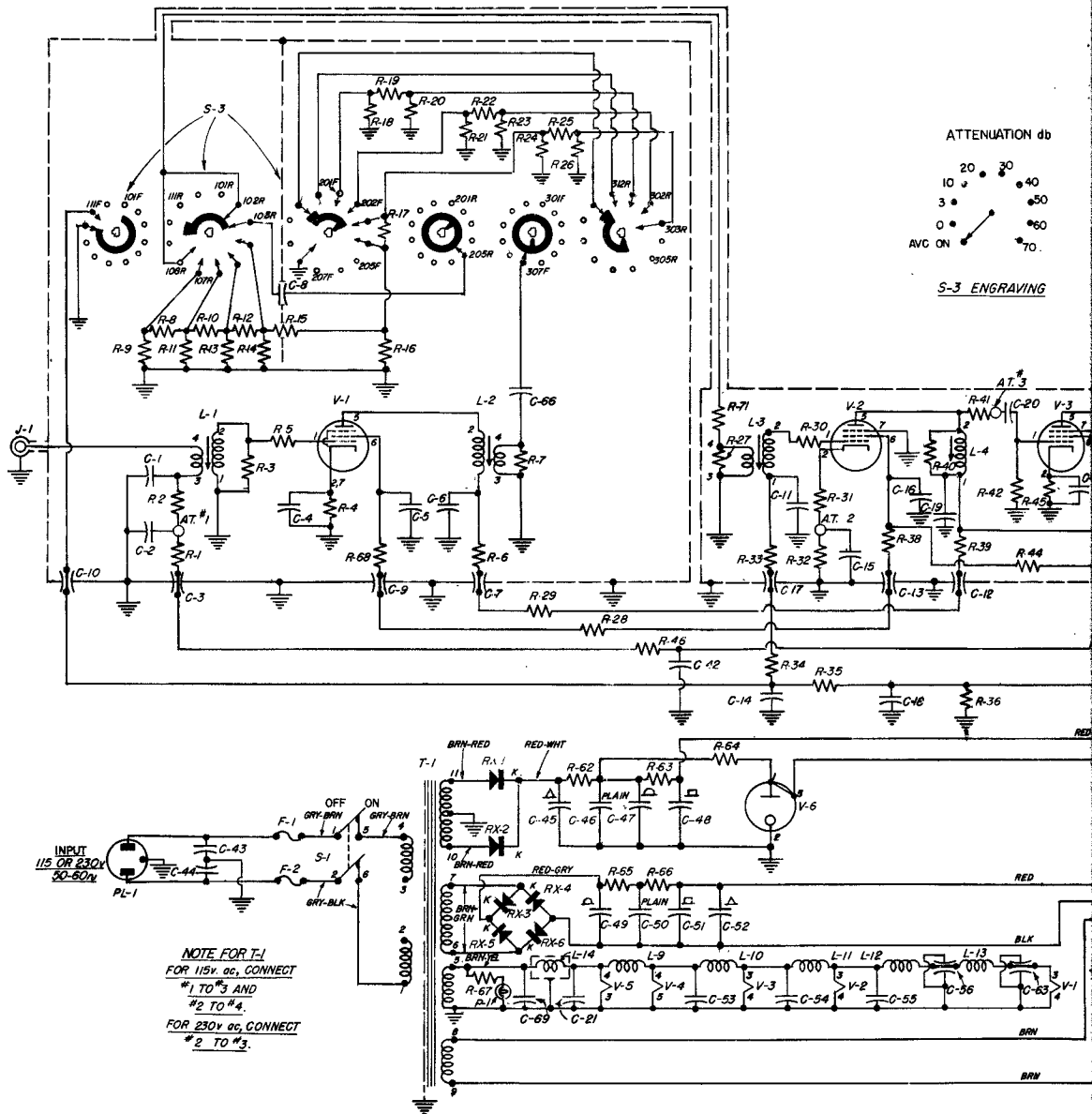

MISCELLANEOUS

- | | | | | |
|------|-------------------|--------------|----------|------------|
| S-1 | DPST | SWT-333 N.P. | J-1 | Jack |
| S-2 | DPDT | SWT-335 N.P. | J-2 | Jack |
| S-3 | | SWRW-93 | J-3 | Jack |
| PL-1 | Part of | CAP-19 | F-1, F-2 | 1 Amp. for |
| SC-1 | | CDMS-5-4 | F-1, F-2 | 0.5 Amp. f |
| T-1 | Power Transformer | 485-481 | | |

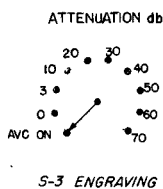

S-3 ENGRAVING

Figure 22.
Complete circuit diagram of the Type 1216-A Unit I-F Amplifier.

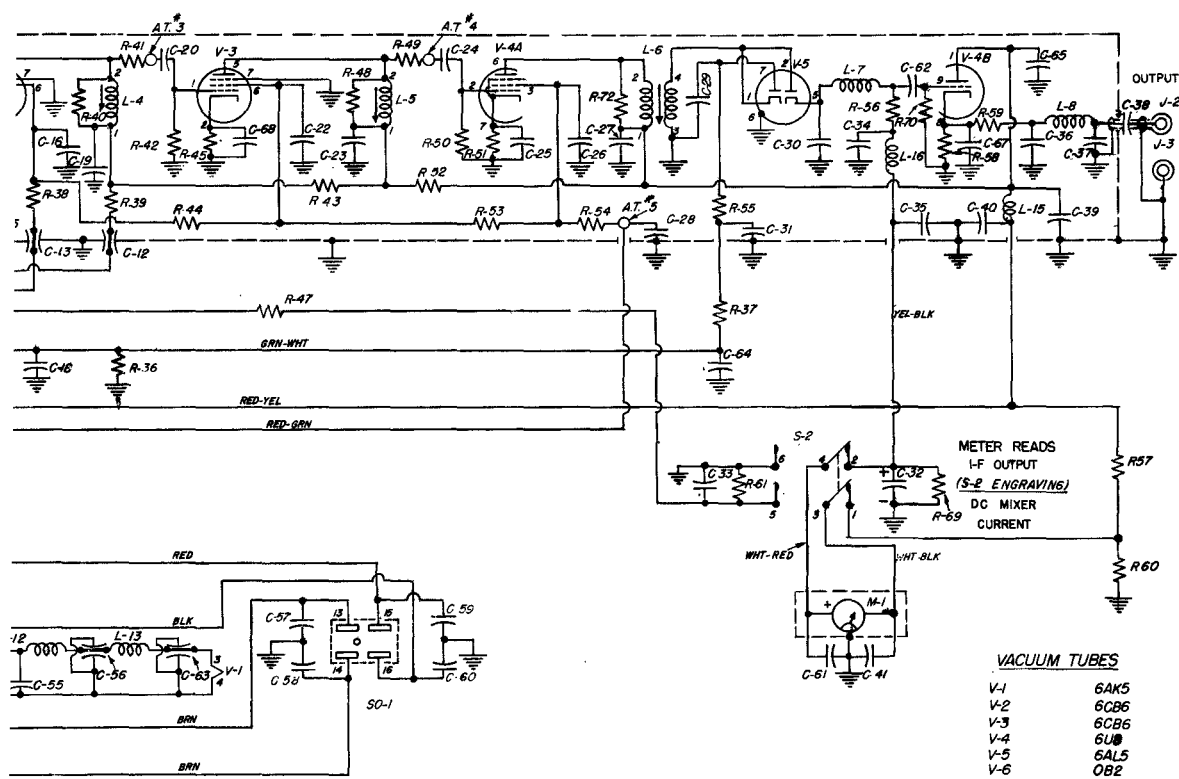

MISCELLANEOUS

Jack	874-337	P-1	Pilot Light	6.3 v. Mazda No. 44
Jack	BP-5	M-1	Meter	0-200 μ a MEDS-117
Jack	BP-5	RX-1	Selenium Rectifier	2RE-11
		RX-2	Selenium Rectifier	2RE-11
		RX-3	Selenium Rectifier	2RE-11
		RX-4	Selenium Rectifier	2RE-11
,F-2	1 Amp. for 115v	RX-5	Selenium Rectifier	2RE-11
,F-2	0.5 Amp. for 230v	RX-6	Selenium Rectifier	2RE-11

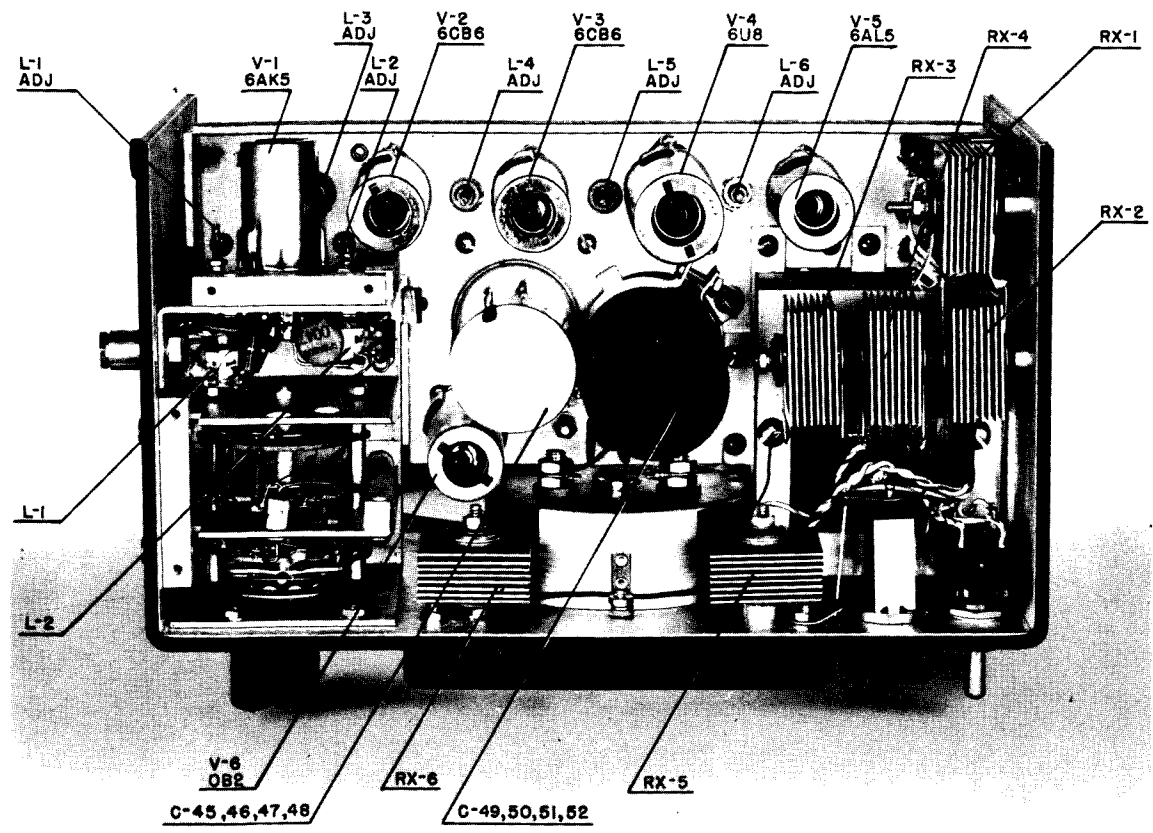

TYPE 1216-A UNIT I-F AMPLIFIER

Figure 20. View of the chassis from the top with the shields removed showing the location of the components.

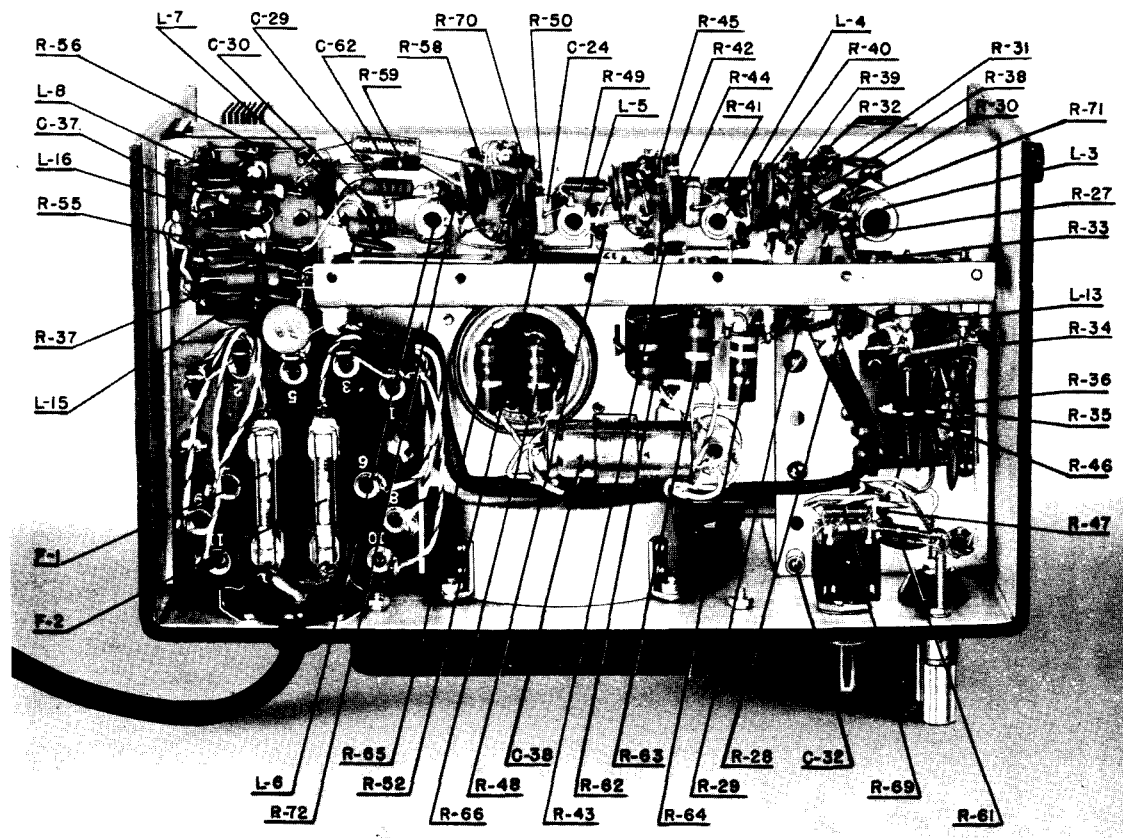

Figure 21. View from below with the shields removed. The i-f amplifier section extends along the rear of the chassis and is normally completely enclosed in a shield.

GENERAL RADIO COMPANY

WEST CONCORD, MASSACHUSETTS

EMERSON 9-4400

MISSION 6-7400

DISTRICT OFFICES

NEW YORK

Broad Ave. at Linden, Ridgefield, N. J.
Telephone N.Y. WORTH 4-2722
N.J. WHITNEY 3-3140

PHILADELPHIA

1150 York Rd., Abington, Penna.
Telephone TURNER 7-8486
Phila., HANCOCK 4-7419

WASHINGTON

8055 13th St., Silver Spring, Md.
Telephone JUNIPER 5-1088

CHICAGO

6605 West North Ave., Oak Park, Ill.
Telephone VILLAGE 8-9400

LOS ANGELES

1000 N. Seward St., Los Angeles 38,
Calif.
Telephone HOLLYWOOD 9-6201

SAN FRANCISCO

1186 Los Altos Ave., Los Altos, Calif.
Telephone WHITECLIFF 8-8233

CANADA

99 Floral Pkwy., Toronto 15, Ont.
Telephone CHERRY 6-2171

REPAIR SERVICES

EAST COAST

General Radio Company
Service Department
22 Baker Ave., W. Concord, Mass.
Telephone EMERSON 9-4400

NEW YORK

General Radio Company
Service Department
Broad Ave. at Linden, Ridgefield, N. J.
Telephone N.Y. WORTH 4-2722
N.J. WHITNEY 3-3140

MIDWEST

General Radio Company
Service Department
6605 West North Ave., Oak Park, Ill.
Telephone VILLAGE 8-9400

WEST COAST

General Radio Company
Service Department
1000 N. Seward St., Los Angeles 38, Calif.
Telephone HOLLYWOOD 9-6201

CANADA

Bayly Engineering, Ltd.
First Street, Ajax, Ontario
Telephone Toronto EMPIRE 2-3741

(Representatives in Principal Overseas Countries)

Printed in USA