

INSTRUCTION MANUAL

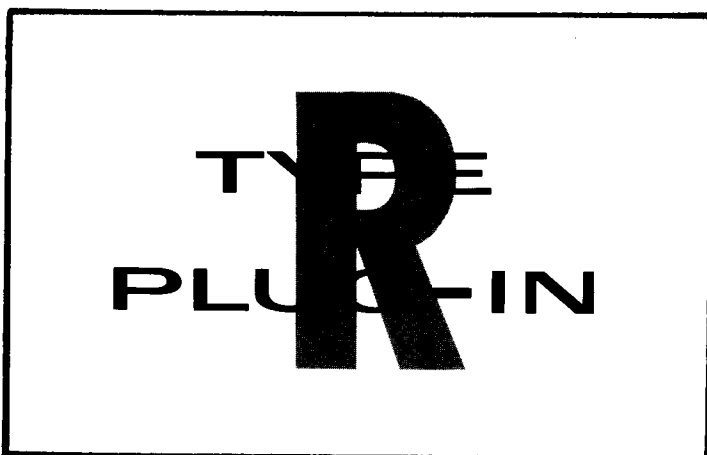

Tektronix, Inc.

S.W. Millikan Way ● P. O. Box 500 ● Beaverton, Oregon ● Phone MI 4-0161 ● Cables: Tektronix

Tektronix International A.G.

Terrassenweg 1A ● Zug, Switzerland ● PH. 042-49192 ● Cable: Tekintag, Zug Switzerland ● Telex 53.574

070-286



WARRANTY

All Tektronix instruments are warranted against defective materials and workmanship for one year. Tektronix transformers, manufactured in our own plant, are warranted for the life of the instrument.

Any questions with respect to the warranty mentioned above should be taken up with your Tektronix Field Engineer.

Tektronix repair and replacement-part service is geared directly to the field, therefore all requests for repairs and replacement parts should be directed to the Tektronix Field Office or Representative in your area. This procedure will assure you the fastest possible service. Please include the instrument Type and Serial number with all requests for parts or service.

Specifications and price change privileges reserved.

Copyright © 1959. New material Copyright © 1961 by Tektronix, Inc., Beaverton, Oregon. Printed in the United States of America. All rights reserved. Contents of this publication may not be reproduced in any form without permission of the copyright owner.



CONTENTS

- Section 1 Specifications
- Section 2 Operating Instructions
- Section 3 Circuit Description
- Section 4 Maintenance
- Section 5 Recalibration Procedure
- Section 6 Parts List and Schematic Diagrams
- Section 7 Accessories

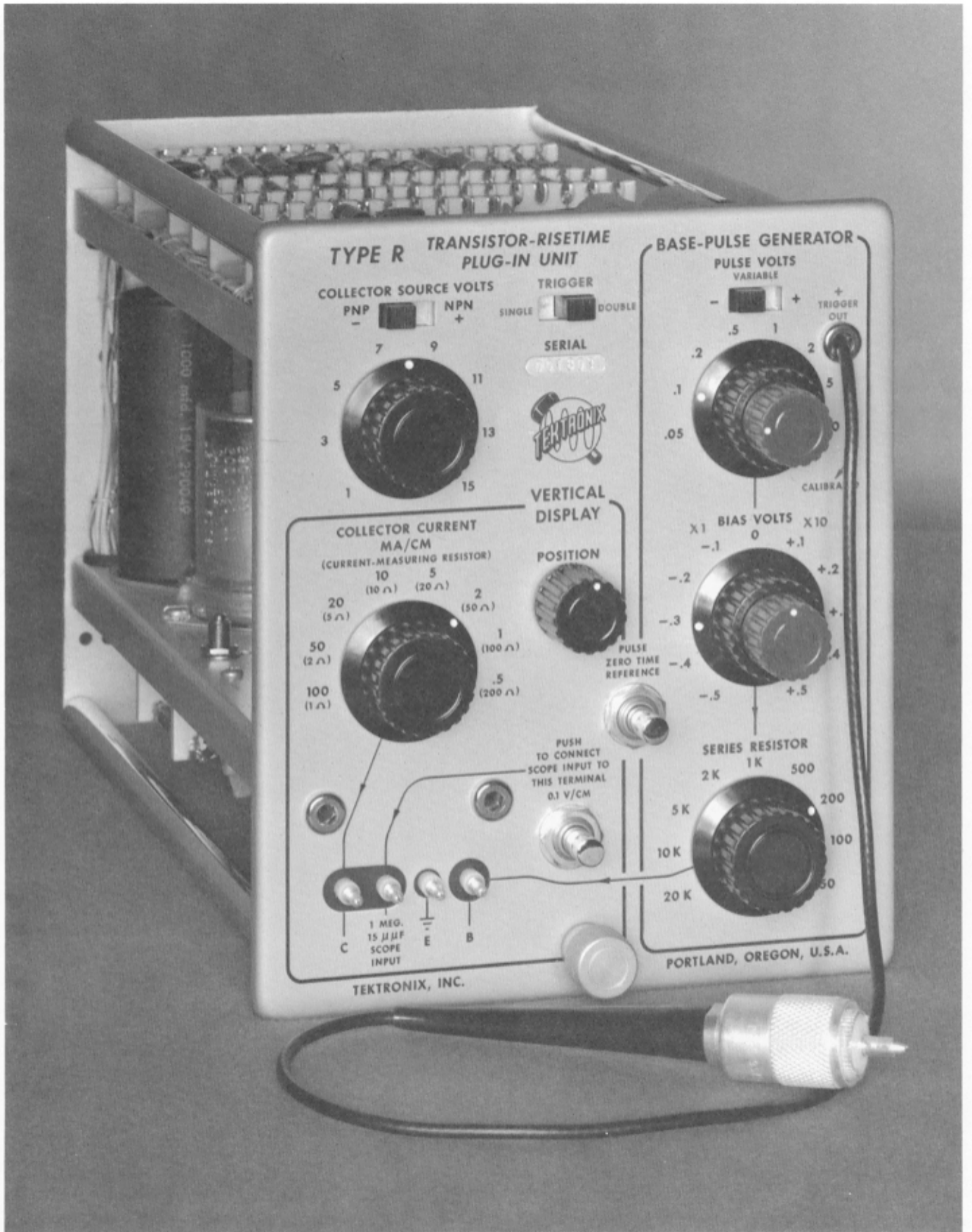

TYPE R TRANSISTOR-RISE TIME PLUG-IN UNIT

COLLECTOR SOURCE VOLTS
 PNP NPN TRIGGER
 SINGLE DOUBLE

7 9 11 13 15
 5 3 1

SERIAL
 TEST
TEKTRONIX

BASE-PULSE GENERATOR

PULSE VOLTS
 VARIABLE
 - .5 1 + TRIGGER OUT
 .2 2
 .1 5
 .05 0
 CALIBRA

COLLECTOR CURRENT
 MA/CM
 (CURRENT-MEASURING RESISTOR)
 10 5
 (10 Ω) (20 Ω)
 20 2
 (5 Ω) (50 Ω)
 50 1
 (2 Ω) (100 Ω)
 100 .5
 (1 Ω) (200 Ω)

VERTICAL DISPLAY
 POSITION

X1 BIAS VOLTS X10
 -.1 0 +.1
 -.2 +.2
 -.3 +.3
 -.4 +.4
 -.5 +.5

PUSH TO CONNECT SCOPE INPUT TO THIS TERMINAL 0.1 V/CM
 C 1 MEG. 15 μ F F SCOPE INPUT
 E B

SERIES RESISTOR
 2 K 1 K 500
 5 K 200
 10 K 100
 20 K 50

TEKTRONIX, INC.

PORTLAND, OREGON, U.S.A.

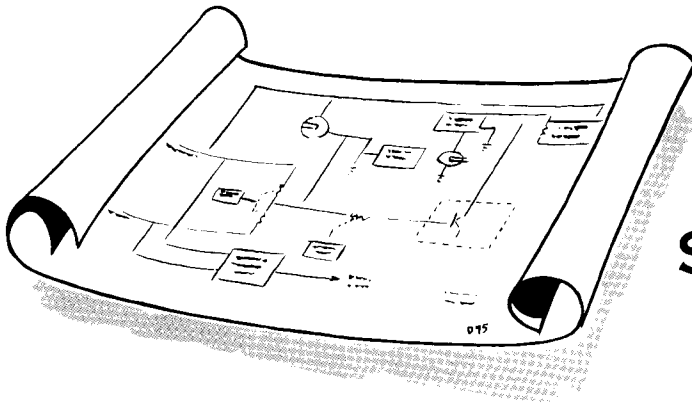

SPECIFICATIONS

The Type R Plug-In Unit is a combined power supply and pulse generator which is used to measure the high-frequency characteristics of junction transistors by the pulse-response method. It is designed to operate with Tektronix 530-, 540-, 550- or 580-Series Oscilloscopes. When the Type R Unit is used in an oscilloscope incorporating a delay line, a display may be obtained which shows delay time, risetime, storage time and falltime simultaneously. In addition, operation of a push-button switch connects a front-panel terminal directly to the input of the oscilloscope. This connection permits you to observe other waveforms, such as the input waveform of the transistor under test.

Pulse Generator

Risetime--less than 5 nanoseconds.

Pulse amplitude--Fixed, calibrated steps of .05, .1, .2, .5, 1, 2, 5 and 10 volts. Adjustable between steps.

Pulse recurrence frequency--120 pulses/sec.

Minimum output impedance--Beginning of pulse, 50 ohms. End of pulse, 50 ohms in all positions of PULSE VOLTS control except as follows: 2-volt position-50 ohms, 5-volt position-63 ohms, 10-volt position-116 ohms.

Maximum output impedance--20 k ohms.

Vertical Display

Collector current--.5, 1, 2, 5, 10, 20, 50 and 100 ma/cm.

TABLE 1

Minimum risetime that can be displayed when the Type R Unit is used with various Tektronix oscilloscopes.

Tektronix Oscilloscope	Risetime (nanoseconds)
Types 541/541A, 543/543A, 545/545A, 581, 585	12
Type 551	14
Types 531/531A, 533/533A, 535/535A	23
Type 536	35
Type 532	70

Regulated Collector Supply

Voltage range--approx. 1 to 15 volts, continuously variable.

Polarity--positive or negative.

Available current--400 ma.

Output Impedance (dc)--less than .1 ohm.

Regulated Bias Supply

Voltage range +.5 through zero to -.5 volt, continuously variable. +5 through zero to -5 volts, continuously variable.

Other Characteristics

Triggering to show risetime, falltime, or both risetime and falltime simultaneously.

Constant-amplitude triggering signal fed to external trigger input of oscilloscope for a stable display.

Zero time reference switch operated from front panel marks the beginning and end of the driving pulse.

Auxiliary front-panel terminal connected to oscilloscope input by operation of a push-button switch.

Increasing collector current displayed upward for p-n-p transistors, downward for n-p-n transistors.

Collector-voltage waveform ac coupled to oscilloscope.

Mechanical

Construction--Aluminum alloy chassis.

Finish--Photoetched panel.

Weight--4 1/2 lbs.

Accessories

2-Instruction manuals.

10-Adapter springs, 344-023.

1-Grounded emitter socket, 386-852.

1-Grounded base socket, 386-853.

OPERATING INSTRUCTIONS

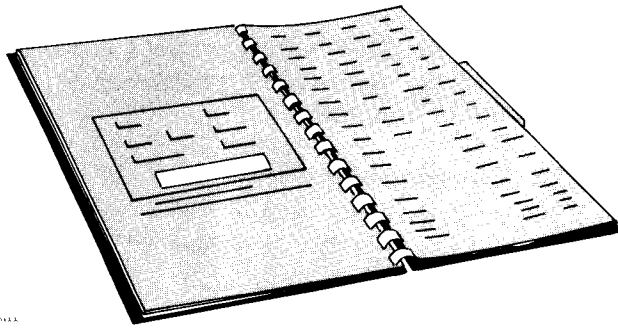

Introduction to Pulse-Response Measurements

The purpose of the Type R Plug-In Unit is to permit you to observe the pulse or switching characteristics of junction transistors in either the grounded-base or the grounded-emitter configuration. These characteristics are not obtainable from ordinary characteristic curves. Since these characteristics vary considerably with different operation conditions, the Type R Plug-In Unit is designed to furnish the transistor under test with a wide range of operating voltages, driving impedances, and load impedances.

The test procedure essentially involves driving either the base or the emitter of a transistor,

through a series resistor, with a pulse whose risetime is faster than 5 millimicroseconds. The response of the transistor under test to this pulse is read out on the cathode-ray tube screen of the associated oscilloscope.

The simplified drawing of Fig. 2-1 shows one of the testing methods used. The transistor under test is being operated in the grounded-emitter configuration. An adjustable bias voltage is connected to the base of the transistor through the PULSE VOLTS control and the SERIES RESISTOR. The pulses from the pulse generator are superimposed on this bias voltage. The solenoid-actuated mercury switch operates at 120 closures per second. The source impedance

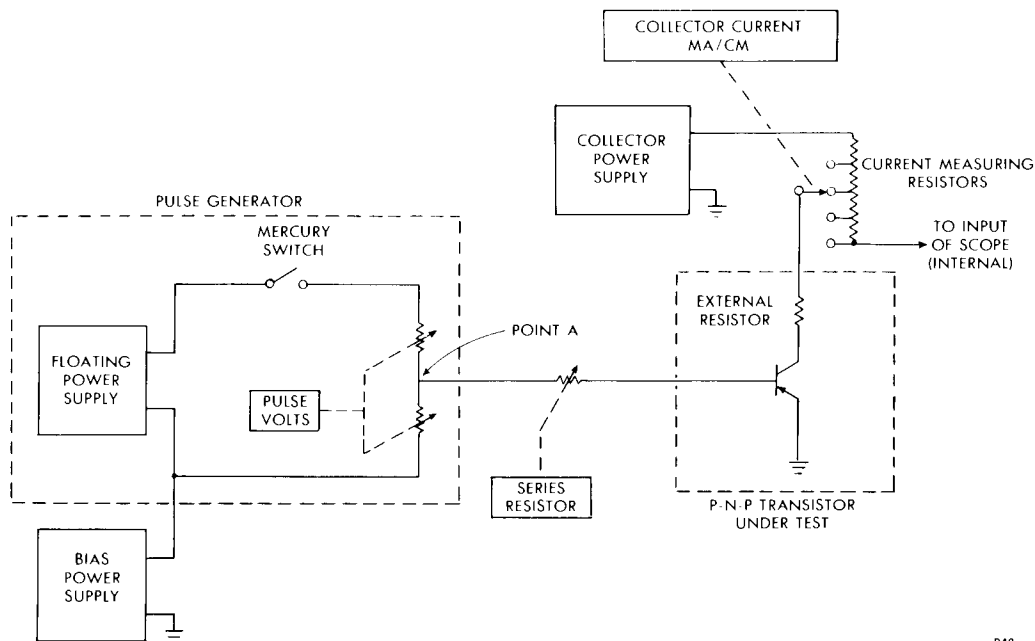

Fig. 2-1. Simplified diagram of the method used for testing a p-n-p transistor in the grounded-emitter configuration.

of the pulse generator (point A to ground) is maintained at 50 ohms. The actual output waveform of the pulse generator is shown in Fig. 2-2.

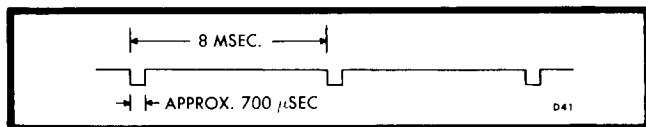

Fig. 2-2. Typical output waveform from the pulse generator with COLLECTOR SOURCE VOLTS switch in P-N-P (-) position. Pulse repetition rate is 120 per second.

The SERIES RESISTOR permits you to drive the transistor under test from an impedance approximating that which you will actually use in your circuit.

The value of the COLLECTOR LOAD RESISTOR is adjustable, both internally and externally, so that you can choose a value which most nearly meets your requirements. Connecting the load resistor externally minimizes stray capacitance, which decreases the response time of the transistor. The voltage change across the internal current-measuring resistance is fed into the vertical amplifier of the oscilloscope.

The four "transistor-plus-circuit" characteristics to be discussed and measured are

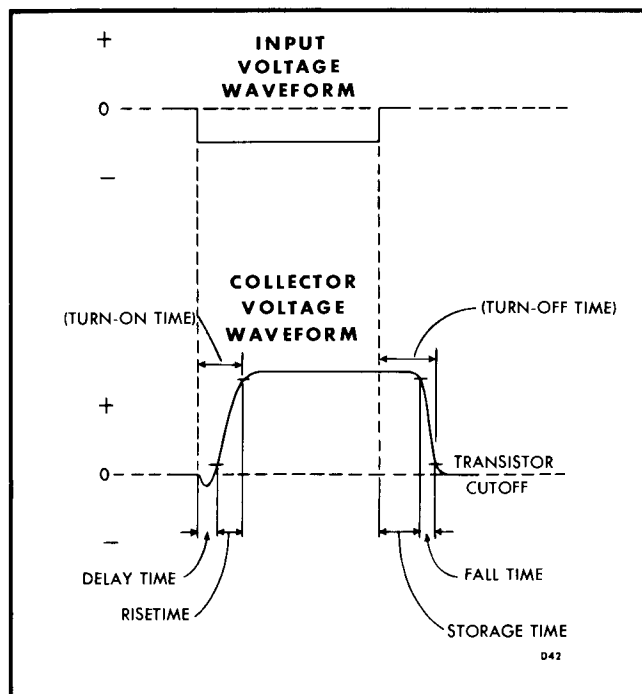

Fig. 2-3. Drawing illustrating the pulse-response characteristics of a p-n-p transistor in the grounded-emitter configuration.

delay time, risetime, storage time and falltime. All are shown with their relationship to the input pulse in Fig. 2-3.

The display presented by means of the Type R Plug-In Unit contains the same information shown in Fig. 2-3, but is presented somewhat differently in order to permit you to derive a maximum of pulse-response information from a single setting of the controls. A typical display on a Tektronix oscilloscope incorporating a delay line is shown in Fig. 2-4.

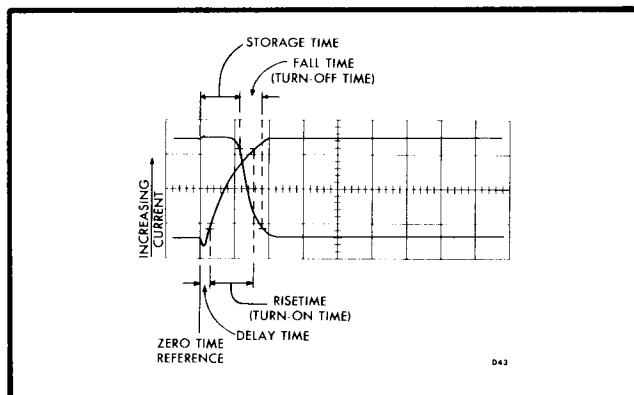

Fig. 2-4. Double-triggered display of the switching characteristics of a p-n-p transistor.

Definitions of pulse-response terms as used in this manual are as follows:

DELAY TIME (propagation time): The time between the application of an input pulse and the time when the output pulse attains 10 per cent of its maximum amplitude in the direction of increasing collector current.

RISETIME: The time interval during which the amplitude of the output voltage changes from 10 per cent to 90 per cent of its maximum value in the direction of increasing collector current.

TURN-ON TIME: The time between the application of an input pulse and the time when the output pulse attains 90 per cent of its maximum amplitude. This term is the sum of the delay time and risetime.

STORAGE TIME: The time between the end of the input pulse and the time when the output pulse has decreased to 90 per cent of its maximum amplitude.

FALL TIME: The time interval during which the amplitude of the output voltage changes

from 90 per cent to 10 per cent of its maximum value in the direction of decreasing collector current.

TURN-OFF TIME: The time between the end

of the input pulse and the time when the output pulse has decreased to 10 per cent of its maximum amplitude. This term is the sum of the storage time and fall time.

SETTING UP A DISPLAY

CLASS-A OPERATION

Preliminary Considerations

Although the Type R Plug-In Unit will operate in any Tektronix oscilloscope of the 530, 540, 550 or 580 series, the oscilloscope you should use will depend on how fast a risetime you are interested in observing. Table 1 on Page 1-1 lists the risetime specifications of combinations of presently available non-rack-mounted oscilloscopes and the Type R Plug-In Unit. Two of these oscilloscopes, Types 532 and 536, are not suitable for displaying very fast pulses because they do not incorporate a signal delay line.

In the procedure that follows, a Type 541A or Type 545A is used to demonstrate the full high-frequency capabilities of the Type R Plug-In Unit.

The first display to be presented will be the "Class A" pulse characteristics of a low-power, p-n-p transistor such as the 2N109. Most audio-type, low-power p-n-p transistors will give similar performance.

Before setting up the controls, consider the limitation of the transistor you have selected for test with respect to its collector dissipation. Since the output of the "R" unit is ac coupled, we have no indication of average collector current or voltage for "Class A" operation without making external connections. To keep the display simple and still prevent possible damage to the transistor under test, a good way to start the display is to first set the front-panel controls so that the transistor under test is cut off. Then you can change the bias until you obtain a display which is suitable for the discussion which follows. Such is the procedure described in the following paragraphs.

Set Type R controls as follows:

COLLECTOR SOURCE	P-N-P, 5 volts
VOLTS	

TRIGGER	DOUBLE
COLLECTOR CURRENT, MA/CM	1 (100 Ω)
PULSE VOLTS	minus, .05
PULSE VOLTS, VARIABLE (red knob)	CALIBRATED
BIAS VOLTS, (black knob)	0
BIAS VOLTS, (red knob)	X1
SERIES RESISTOR	1K

Set Oscilloscope controls as follows:

TRIGGERING LEVEL	Clockwise
STABILITY	Clockwise
TRIGGERING MODE	AC FAST (AC LF REJECT)
TRIGGER SLOPE	EXT, +
Sweep rate	10 μ sec/cm

Connect the +TRIGGER OUT cable from the "R" Unit to the TRIGGER INPUT of the oscilloscope. Connect the transistor to be tested and an external resistor to the Test Board. Then attach the Test Board to the front panel of the "R" Unit and turn the oscilloscope power switch to ON.

Adjust the appropriate controls for a moderately bright horizontal trace which passes through the line that is one major division below the center of the graticule. Slowly turn the black, BIAS VOLTS knob from 0 to a negative voltage until you obtain two traces which are separated by 2 cm (two major divisions). Then turn the STABILITY knob counterclockwise until you reach a point a little beyond where the trace disappears. Now turn the TRIGGERING LEVEL control toward zero until a stable, double-trace display appears, such as the one shown in Fig. 2-5. The response of the audio transistor as it is used to present this display is quite slow, and not all the pulse-response characteristics previously discussed will be present. Note that the drawing of this display (Fig. 2-5) is quite different

from that of Fig. 2-4 in that the trace is so slow the effect of the delay line in the oscilloscope and the delay time of the transistor are not observable. In this display, the input pulse starts at the point marked 0 on the TIME axis. You may determine the starting point of the input pulse by pressing the PULSE ZERO TIME REFERENCE button. Zero time for turn-on and turn-off may not lie in a vertical plane because of a slight difference in sweep triggering. Since the display here is almost symmetrical, the transistor is operating "Class A", i.e., somewhere between cutoff and saturation.

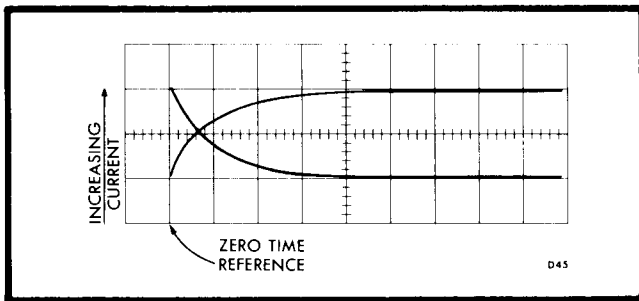

Fig. 2-5. Pulse response of a type 2N109 p-n-p transistor operating Class A. Sweep speed is 10 $\mu\text{sec}/\text{cm}$.

Measuring the Risetime

Adjust the BIAS VOLTS control so that the right-hand portion of the display is exactly two divisions high. Move the display horizontally so that the upper trace intersects the center, vertical graticule line at the point shown in Fig. 2-6.

Recall that the risetime is defined as the time interval between the 10% and 90% amplitude levels in the direction of increasing collector current. By making the total height of the double triggered display 2 centimeters, the 10% and 90% amplitude levels are marked by minor graticule divisions. To determine the risetime, measure the distance in centimeters between

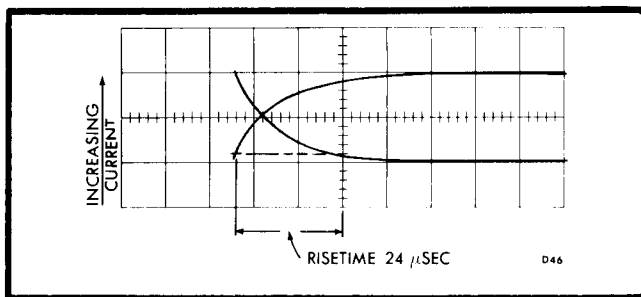

Fig. 2-6. A method of positioning the display so that the risetime can be measured accurately.

the center graticule line and the point where the trace would intersect a 10% amplitude mark. For the display shown, with a horizontal sweep rate of 10 μsec per centimeter, the risetime is approximately $2.4 \times 10 \mu\text{sec}$ or 24 μsec . Falltime is calculated in the same manner.

Using the Series Resistor

Move the SERIES RESISTOR control from 1K to 20K and watch the effect on the trace at each intermediate switch position. Two things will be apparent. One is that the amplitude of the display will diminish. This happens because the bias voltage at the base of the transistor is approaching zero (cut-off). Recall that the biasing current flows through the SERIES RESISTOR and that the input resistance of a transistor is relatively low in the grounded-emitter configuration. The other effect you will notice is that the risetime and falltime will increase since the input capacitance of the transistor has more effect on the pulse-response time as the driving impedance increases. The two causes mentioned are not the only ones in operation since the current gain and other factors within the transistor are varying also.

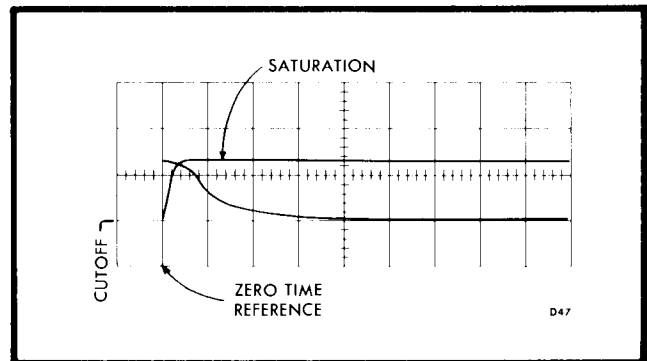

Fig. 2-7. Response of a type 2N109 transistor driven into saturation.

Now move the SERIES RESISTOR control from 1K to 50 ohms and observe the effect on the trace at each switch position. The upper trace should flatten out. If it doesn't move the BIAS VOLTS control to a more negative setting by a small amount until you get a pronounced flattening of the upper trace in the 50-ohm position of the SERIES RESISTOR control. A typical display is shown in Fig. 2-7. The flat portion of the trace presents transistor saturation. During this time the collector voltage is almost zero and the current is limited only by the Current-Measuring Resistor (100 Ω) and the external resistor.

As you changed the setting of the SERIES RESISTOR control toward 50 ohms, the size of the input pulse reaching the base of the transistor increased due to a changing ratio between the input resistance of the transistor and the driving impedance. The risetime and falltime of the pulse occurring at the base of the transistor also decreased because of the lowered driving impedance. Accordingly, the turn-on time, as read on the crt, decreased considerably. In addition, the average bias on the transistor increased in a negative direction, resulting in an increase in the average collector current.

The falltime (lower trace of Fig. 2-7) increased due to the effect of storage time. The storage time and falltime increases rapidly as the transistor is driven further into the saturation region. Move the BIAS VOLTS control slightly more negative to see this effect, but be careful not to go too far. When the SERIES RESISTOR is set at 50 ohms, the base current increases rapidly with increasing negative bias and it is possible to damage the transistor.

SWITCHING OPERATION

Grounded-Emitter Configuration

Recall that the pulse voltage from the BASE-PULSE GENERATOR is superimposed on the bias voltage. The two voltages then are fed to the input of the transistor through the SERIES RESISTOR. If you want to test for switching operation of a transistor, it is necessary to set the bias voltage beyond cutoff and then let the peak of the input pulse drive the transistor from cutoff to saturation. Although the 2N109 is not intended for fast switching, it will be used in the following test of switching characteristics because it shows the pulse-response characteristics at such a slow speed that the display can be examined in detail in ordinary room light. Remove the transistor; then set controls as follows:

Collector Current, MA/CM	5 (20 Ω)
COLLECTOR SOURCE	P-N-P, 10
VOLTS	
BIAS VOLTS (red knob)	X10
BIAS VOLTS (black knob)	+ .5
PULSE VOLTS	-5
SERIES RESISTOR	100
Sweep Speed	.2 μ sec/cm

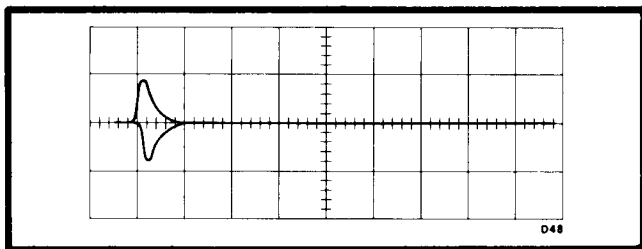

Fig. 2-8. Display of current which flows in the collector circuit as a result of capacitive feed-through of the input pulse. The transistor is cut off.

Now insert the transistor into its socket and observe the display. If your transistor is similar to the 2N109 you should get a display like the enlarged drawing of Fig. 2-8. This is, of course, capacitive feed-through from the base to the collector. A slight difference in the zero time reference exists between the two traces. This time difference varies with the setting of the TRIGGERING LEVEL control.

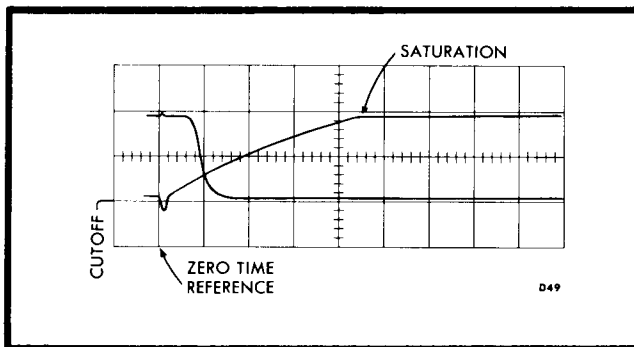

Fig. 2-9. Switching characteristics of a type 2N109 operating in the grounded-emitter configuration.

If you change the setting of the SERIES RESISTOR control, you will see the higher-frequency components of this waveform disappear. If you change the red PULSE VOLTS control, you will see that the amplitude is proportional to the pulse voltage. As you change the BIAS VOLTS control to obtain a 2 cm display in the following paragraph, note that portions of the capacitance feedthrough waveform remain on the display. This is especially true of the notch comprising most of the delay time.

Now set the sweep speed to .5 μ sec/cm. Slowly turn the BIAS VOLTS control (black

knob) until you get a display approximately 2 centimeters high. A typical display is shown in Fig. 2-9. Use the PULSE ZERO TIME REFERENCE button to determine the zero times on your display. If the display is 2 centimeters high, your transistor is switching about 10 milliamperes of current. The switching

current is limited by the external series resistor.

Grounded-base Configuration

The input resistance of the transistor under test is much lower in the grounded-base configuration than it is in the grounded-emitter configuration. Consequently, you will probably use the SERIES RESISTOR in only the low-resistance ranges. The polarity of the input pulse should be positive for a p-n-p transistor. The BIAS VOLTS control should be set initially to a negative voltage and then turned toward a more positive voltage until the transistor is operating in the mode you desire.

The drawing of Fig. 2-10 is the display obtained from a 2N269 driven into the saturation region.

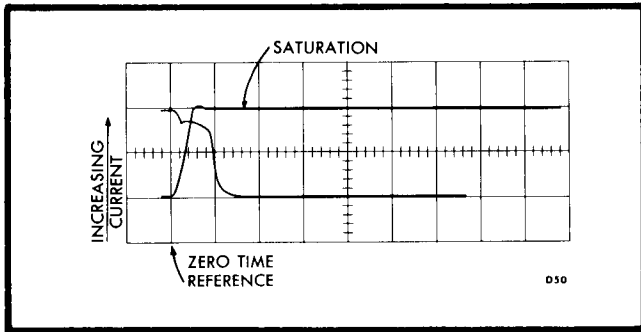

Fig. 2-10. Switching characteristics of a type 2N269 operating in the grounded-base configuration. Sweep rate is 1 μ sec. per centimeter.

OTHER OPERATING INFORMATION

Transistor Mounting Boards

Transistor mounting boards must be used to make the connections between the test transistor and the R Unit. A total of six types of transistor mounting boards are available from Tektronix. Of the six boards available, three are used to operate the test transistor in the grounded-base configuration and three are used to operate the test transistor in the grounded-emitter configuration. The primary difference between the three mounting boards of each type is the type socket used to connect

the transistor to the board. Table 2-1 lists the specific details of the construction of the various transistor mounting boards. The transistor mounting boards are illustrated in Figure 2-11. Transistor mounting boards not shipped with the Type R Unit may be ordered directly from the factory or through your local Field Engineering Office.

The transistor mounting boards provide the means for operating the test transistor in an actual circuit while characteristics of the transistor and circuit are checked. Markings on the transistor mounting boards provide a guide to the placement of the various components that are mounted on the board to simulate the transistor circuit. You must select the components which will satisfy your particular requirements and mount these components on the board. If you desire to check characteristics of the transistor alone, you may use the transistor mounting boards with jumpers connected in place of the various circuit components. However, to reduce the possibility of accidental damage to the transistor, it is desirable to operate the test transistor with a collector load resistor.

The two transistor mounting boards shipped with the R Unit are supplied with 220-ohm resistors connected as the collector load resistor (RL). This value is chosen for its adaptability to most applications, while at the

TABLE 2-1

TRANSISTOR MOUNTING BOARD DATA

PART NO.	TYPE	SOCKET TYPE
*386-852	Grounded Emitter	4-pin transistor socket
*386-853	Grounded Base	Same as 386-852
386-854	Grounded Emitter	Socket for power transistors such as the 2N301 and 2N307.
386-855	Grounded Base	Same as 386-854
386-856	Grounded Emitter	Funnel-type socket for standard transistors with long leads
386-857	Grounded Base	Same as 386-856

*Included with the accessories shipped with the Type R Unit.

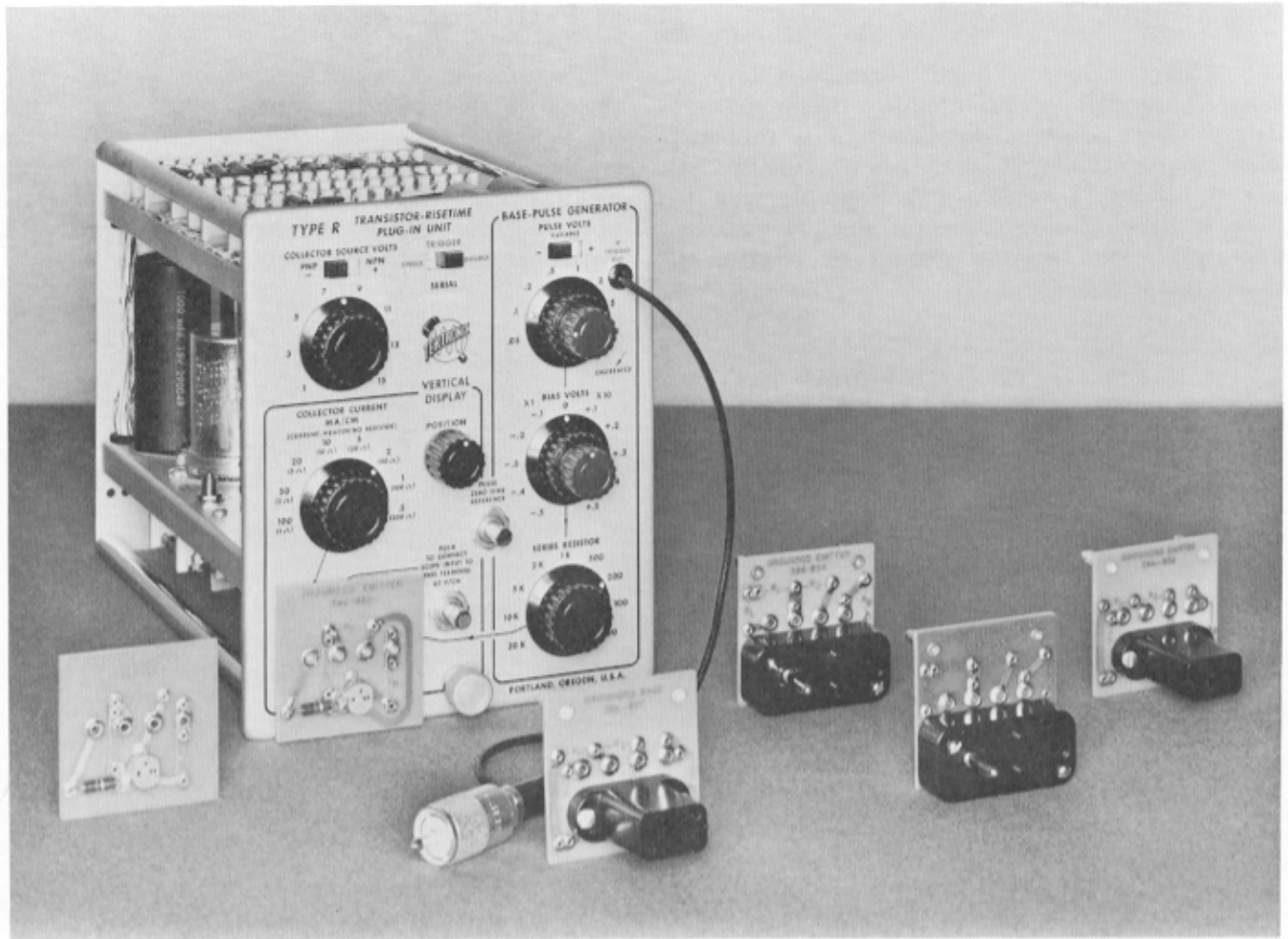

Fig. 2-11. The Type R Plug-In Unit and the transistor mounting boards available for use with the unit.

same time providing a reasonable measure of protection for the test transistor. The value of R_L may be changed if you so desire.

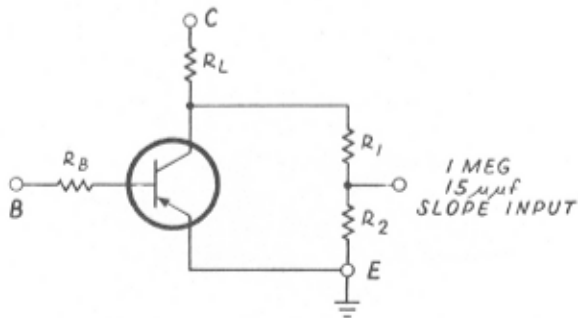

Fig. 2-12. Typical grounded-emitter transistor mounting board circuit.

Figures 2-12 and 2-13 show schematically the transistor mounting board circuits used for grounded-emitter and grounded-base opera-

tion of the test transistor. The values for all components must be selected by you. If desired, the basic circuits shown in Figures 2-12 and 2-13 may be modified to include more or less components.

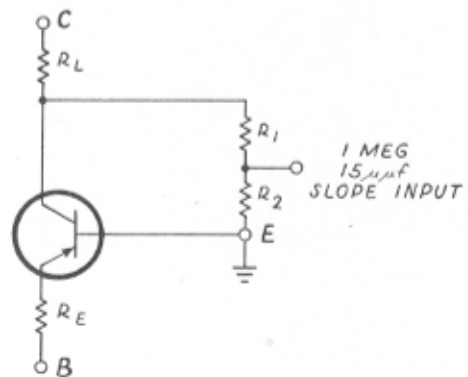

Fig. 2-13. Typical grounded-base transistor mounting board circuit.

Scope Input Terminal

This direct-coupled input terminal was provided to permit you to monitor the waveform at the input of the transistor. For this and other applications, it may be necessary for you to make a resistive voltage divider to prevent driving the trace off the crt screen. The peak input voltage should be limited to about .4 volt.

N-P-N Transistors

The display of the pulse-response characteristics of an n-p-n transistor differs from that of p-n-p transistors. Recall that for p-n-p transistors, collector current was increasing as the trace moved upward. For n-p-n transistors, the trace moves downward as the collector current increases.

SECTION 3

CIRCUIT DESCRIPTION

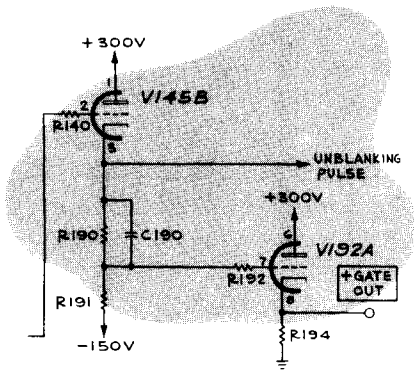

Pulse Generator

Output of the pulse generator is formed by interrupting the dc output of the floating power supply at a 120-cycle rate with solenoid-actuated mercury switch SW5803. Polarity switch SW6861 reverses output connections of the floating power supply so that output pulses of either polarity may be generated. The mercury switch interrupts current flow through resistors of series R5810 and R5815 where the pulses are developed. The output of the Pulse Generator is at the junction of the parallel combination L5812, R5812, R5811 and the SERIES RESISTOR switch. Resistors of series R5810 and R5815 were chosen to make the output impedance of the Pulse Generator equal to 50 ohms when the mercury switch is closed. When the mercury switch is open, the output impedance is higher for some settings of the PULSE VOLTS control. The simplified diagram of Fig. 3-1 is used to explain these impedance variations.

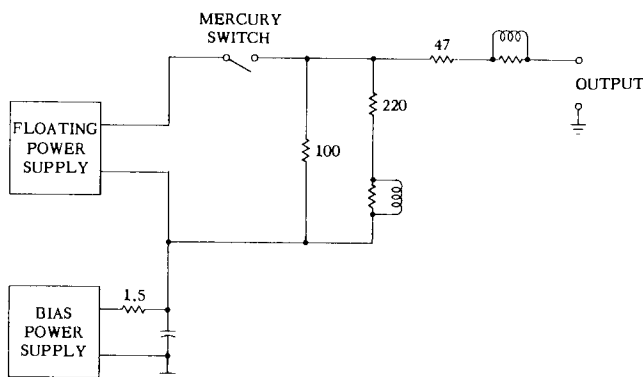

Fig. 3-1. Simplified diagram of the Pulse Generator.

This diagram shows the equivalent circuit with the PULSE VOLTS control in the 10 volts position. When the mercury switch is closed, the impedance at the output will be close to 50 ohms. This impedance is made up of the 47-ohm resistor in series with the impedance of the power-supply circuitry. The resistance

of the mercury-switch contacts is negligible. When the mercury switch is open, the impedance is made up of the 47-ohm resistor in series with the parallel combination of the 100-ohm and 220-ohm resistors. In this case, the impedance will be about 116 ohms. In the lower voltage ranges of the PULSE VOLTS control, other resistance values are used which reduce the output impedance. In the 5-volt range, the open-switch impedance is 63 ohms and in the 2-volt range, 53 ohms. In the voltage ranges below 2 volts, the impedance will be very close to 50 ohms.

The input pulse driving the transistor under test is applied through an impedance consisting of the output impedance of the pulse generator in series with a resistor selected by SERIES RESISTOR switch SW5820. The SERIES RESISTOR control permits selection of resistances which allow the transistor to be driven from a wide range of source impedances.

Triggering Circuit

The purpose of the Triggering Circuit is to supply a positive-going pulse coincident with either the closing of the mercury-switch contacts, or the closing and the opening of these contacts. This positive-going pulse is used to start the horizontal sweep of the oscilloscope. The operation of the Triggering Circuit in the SINGLE and DOUBLE positions of the TRIGGER switch will be described separately.

1. SINGLE position

Refer to the circuit diagram titled Pulse Generator, Triggering Circuit, and amplifier. The Triggering Circuit is made up of V5833, V5834 and V5844. The control grids of V5834 and V5844 are connected across the pulse Generator at points where the pulse amplitude is always between 6 and 10 volts.

Between pulses (mercury switch open), both control grids are at the same potential. If the Pulse Generator is supplying positive pulses, the closing of the mercury switch will cause the grid of V5834 to go several volts positive with respect to the grid of V5844. Conduction through V5834 will increase and V5844 will be cut off. Conduction through V5833B will increase and V5833A will be cut off. By cathode-follower action, the voltage at the cathodes of V5833A and V5833B will change in a positive direction. The leading edge of this voltage change triggers the horizontal sweep of the oscilloscope. When the output of the Pulse Generator returns to its base level, all tubes return to their quiescent condition.

The time relationship between some of the waveforms which occur in the Triggering Circuit during the presentation of a single-sweep display are shown in Fig. 3-2.

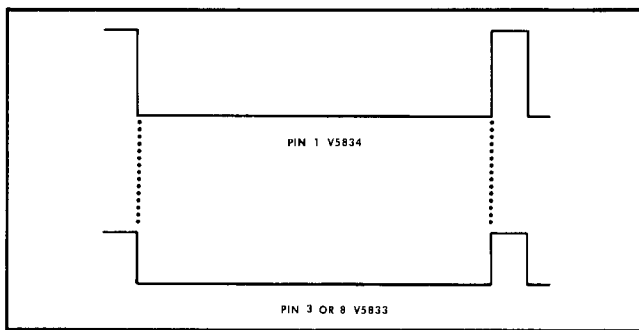

Fig. 3-2. Triggering circuit waveforms with single-triggered operation.

2. DOUBLE position

In double-triggered operation, the time constant of C5824 and R5826 plays an important part. As the circuit operation is described, refer to the appropriate waveform of Fig. 3-3.

Assume that a positive-going pulse is again applied to the control grid of V5834. At the first instant, the circuit performs the same as in single-triggered operation. After the first instant, C5824 charges through R5826 to the amplitude of the input pulse. A new quiescent level is reached because both control grids of the difference amplifier are again at the same potential. Since only the leading edge of the output pulse is used to trigger the oscilloscope sweep, the decay of this output pulse as C5824 charges is of no consequence.

At the end of the incoming pulse, V5834 is driven beyond cutoff, V5833A increases

conduction and V5833B is cut off. The result of this action is another positive-going output pulse.

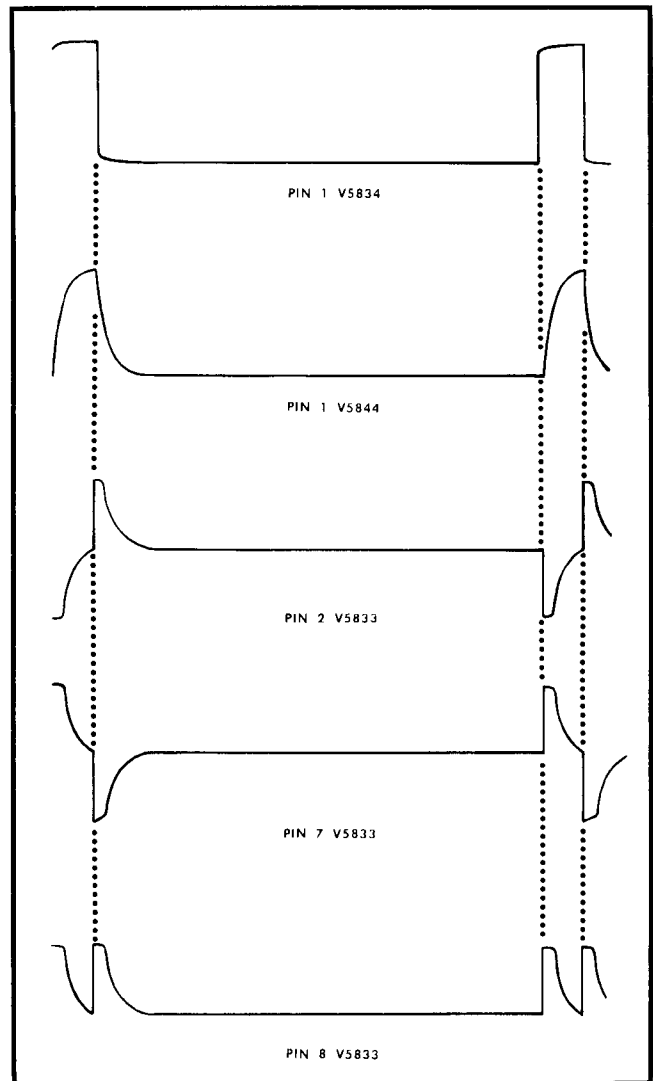

Fig. 3-3. Triggering circuit waveforms with double-triggered operation.

Output Amplifier

The output amplifier consists of a difference amplifier (V5884 and V5894) and an impedance matching stage to couple the difference amplifier output to the oscilloscope input. The purpose of the difference amplifier is to change the pulse signal from the collector circuit of the transistor under test into two equal-amplitude signals of opposite phase. The oscilloscope requires this push-pull input signal.

The plate and cathode circuits of V6803A and V6803B are cross coupled through C6807 and C6809 to lower their high-frequency differential output impedance. The differential

output impedance obtained is lower than that which can be realized by operating these tubes as cathode followers.

Regulated Power Supplies

Note

In earlier model R units, Transistors are designated as "V" Circuit Numbers.

1. Bias Power Supply

The Bias Power Supply provides continuously variable output voltages between +5 volts and -5 volts dc. A simplified diagram of the power-control circuit is shown in Fig. 3-4. Referring to this diagram, if a negative-going voltage is applied to the input, Q6887 will increase conduction and the voltage at point A (the output) will move in a positive direction. At the same time, the base of Q6877 is driven in a positive direction, causing Q6877 to conduct less. This action also causes the voltage at point A to go more positive.

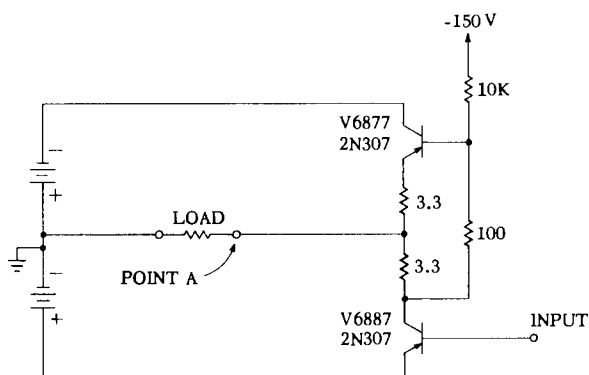

Fig. 3-4. Simplified diagram of the power-control section of the Bias Power Supply.

Referring now to the complete diagram of the Bias Power Supply, note the following:

1. The voltages applied to R6894 and the resistors connected to it are constant. Therefore, the voltage at the tap on R6894 can be used as a variable reference voltage.
2. The emitter of n-p-n transistor Q6884 is connected to the output of the supply, and the base is connected to the variable reference voltage.
3. Q6884, then, operates like the voltage amplifier in the vacuum-tube equivalent of this voltage-regulated supply.

4. Q6883 acts as an emitter follower to drive power transistor Q6887.

The operation is most easily understood by following the phase of an assumed error signal through the supply. Assume the output voltage has instantaneously moved in a negative direction due to external loading. This error signal is applied to the emitter of Q6884. There is no phase inversion through either Q6884 or Q6883. Recall that a negative voltage applied to the base of Q6887 causes the output voltage to increase. The resulting increase in output voltage compensates for the decrease in output voltage assumed at the beginning.

2. Collector Power Supply

The collector power supply provides variable positive or negative outputs between 1 and 15 volts. Switch SW6841 reverses power supply output connections to provide either polarity. In the following circuit description, it is assumed that switch SW6841 is in the PNP- position thereby grounding the emitter of Q6832. Operation of the power supply with SW6841 in the NPN+ position is identical except for the output connections.

A voltage divider consisting of resistors R6843, R6840, R6841, R6838, and R6842 is connected between the power supply output and regulated +225 volts. The setting of the COLLECTOR SOURCE VOLTS control, R6841, determines the bias on transistor Q6832 and consequently the output voltage of the power supply. Changes in the power supply output voltage produce corresponding changes in the voltage applied to the base of Q6832. These voltage changes are amplified and applied to series regulator Q6837 causing the power supply output voltage to return to the correct level.

If the output voltage should increase negatively for example, a negative signal is applied to the base of Q6832 causing an increase in collector current. The resulting decrease in negative voltage at the base of emitter follower Q6833 produces a positive signal at the base of series regulator Q6837. Voltage dropped across the series regulator is thereby increased, decreasing the power supply output voltage to the correct level. Operation of the circuit in the event of a decrease in output voltage is identical except that signal voltage polarities are reversed.

3. Floating Power Supply

Operation of the floating power supply is identical to that of the collector power supply. The circuit description for the collector power

supply may therefore be used to explain operation of the floating power supply by substituting corresponding components of the floating power supply.

SECTION 4

MAINTENANCE

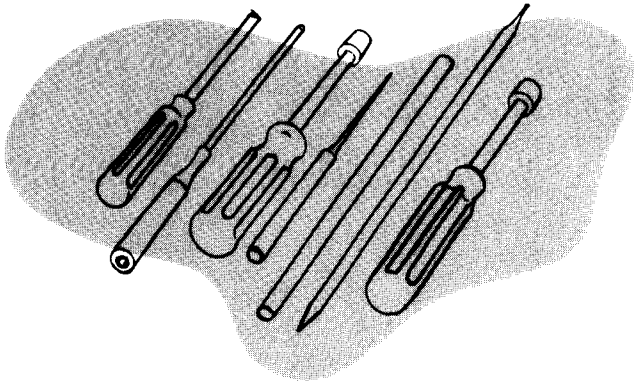

PREVENTIVE MAINTENANCE

Recalibration

The Type R Plug-In Unit is designed for maximum stability and should not require frequent recalibration. However, to insure the accuracy of measurements, we suggest that you recalibrate the instrument after each 500-hour period of operation (or every six months if the unit is used intermittently). A complete step-by-step procedure for recalibrating the unit and checking its operation is given in the Recalibration section of this manual. The accuracy of measurements made with the Type R Unit depends not only on the accuracy of the Type R Unit calibration but on the associated oscilloscope calibration as well. Therefore, it is essential that the oscilloscope be maintained in proper calibration.

Visual Inspection

Many potential and existent troubles can be detected by a visual inspection of the unit. For this reason, you should perform a complete visual check every time the instrument is recalibrated or repaired. Apparent defects may include loose or broken connections, damaged connectors, improperly seated tubes and transistors, scorched or burned parts, or broken terminal strips, as well as many other troubles. The remedy for these troubles is readily apparent except in the case of heat-damaged parts. Damage of parts due to heat is often the direct result of other, less apparent troubles in the circuit. It is essential that you determine the cause of overheating before replacing the damaged parts to prevent damage to the new components.

COMPONENT REPLACEMENT

The procedures for replacing most parts in the Type R Unit are obvious. Detailed

instructions for their removal are therefore not required. Other components, however, can best be removed if a definite procedure is followed or if certain precautions are taken. Additional information for the replacement of some of these parts is contained in the following paragraphs. Because of the nature of the instrument, replacement of certain parts will require that you recalibrate portions of the instrument to insure proper operation. Refer to the Recalibration section of this manual.

Tubes

Care should be taken both in preventive and corrective maintenance that tubes are not replaced unless they are actually causing a definite circuit malfunction. Many times during routine maintenance it will be necessary for you to remove tubes from their sockets. It is important that these tubes be returned to the same sockets unless they are actually defective. Needless replacement or switching of tubes will many times result in unnecessary recalibration of the instrument. If tubes do require replacement, it is recommended that they be replaced by previously checked high-quality tubes.

Mercury Switch

Special care is required to replace the mercury switch. The switch consists of a glass envelope containing the contacts, the mercury reservoir, and a gas under high pressure. If the glass should be broken or cracked during removal or replacement of the switch, the envelope will likely explode. This could produce serious injury to the eyes due to flying glass.

Switches

Methods for removal of defective switches are for the most part obvious and only a

normal amount of care is required. Single wafers are normally not replaced on the switches used in the Type R Unit, and if one wafer is defective, the entire switch should be replaced. Switches may be ordered from Tektronix either wired or unwired as desired.

The shield around the PULSE VOLTS switch is ungrounded and is connected to one side of the output of the pulse power supply. Consequently, extra care should be taken, if the PULSE VOLTS switch is replaced, to see that the shield remains ungrounded. A resistance check should be made from the shield to ground after the switch is replaced and before the power is applied to the instrument.

Soldering and Ceramic Strips

Many of the components in your Tektronix instrument are mounted on ceramic terminal strips. The notches in these strips are lined with a silver alloy. Repeated use of excessive heat, or use of ordinary tin-lead solder will break down the silver-to-ceramic bond. Occasional use of tin-lead solder will not break the bond if excessive heat is not applied.

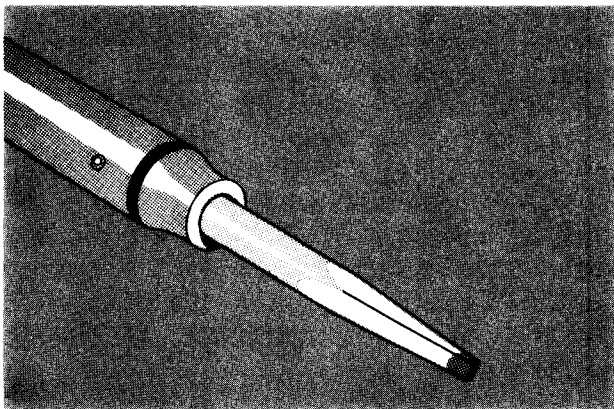

Fig. 4-1. Soldering iron tip properly shaped and tinned.

If you are responsible for the maintenance of a large number of Tektronix instruments, or if you contemplate frequent parts changes, we recommend that you keep on hand a stock of solder containing about 3% silver. This type of solder is used frequently in printed circuitry and should be readily available from radio-supply houses. If you prefer, you can order directly from Tektronix in one-pound rolls. Order by Tektronix part number 251-514.

Because of the shape of the terminals on the ceramic strips it is advisable to use a wedge-

shaped tip on your soldering iron when you are installing or removing parts from the strips. Fig. 4-1 will show you the correct shape for the tip of the soldering iron. Be sure and file smooth all surfaces of the iron which will be tinned. This prevents solder from building up on rough spots where it will quickly oxidize.

When removing or replacing components mounted on the ceramic strips you will find that satisfactory results are obtained if you proceed in the manner outlined below.

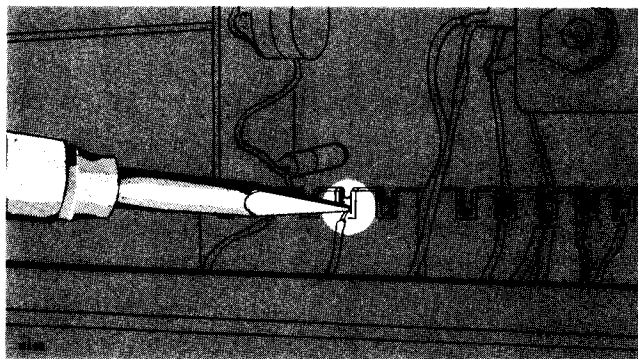

Fig. 4-2. Correct method of applying heat in soldering to a ceramic strip.

1. Use a soldering iron of about 75-watt rating.
2. Prepare the tip of the iron as shown in Fig. 4-1.
3. Tin only the first 1/16 to 1/8 inch of the tip. For soldering to ceramic terminal strips tin the iron with solder containing about 3% silver.
4. Apply only one corner of the tip to the notch where you wish to solder (see Fig. 4-2).
5. Apply only enough heat to make the solder flow freely.
6. Do not attempt to fill the notch on the strip with solder; instead, apply only enough solder to cover the wires adequately, and to form a slight fillet on the wire as shown in Fig. 4-4.

In soldering to metal terminals (for example, pins on a tube socket) a slightly different technique should be employed. Prepare the iron as outlined above, but tin with ordinary tin-lead solder. Apply the iron to the part to

be soldered as shown in Fig. 4-3. Use only enough heat to allow the solder to flow freely along the wire so that a slight fillet will be formed as shown in Fig. 4-4.

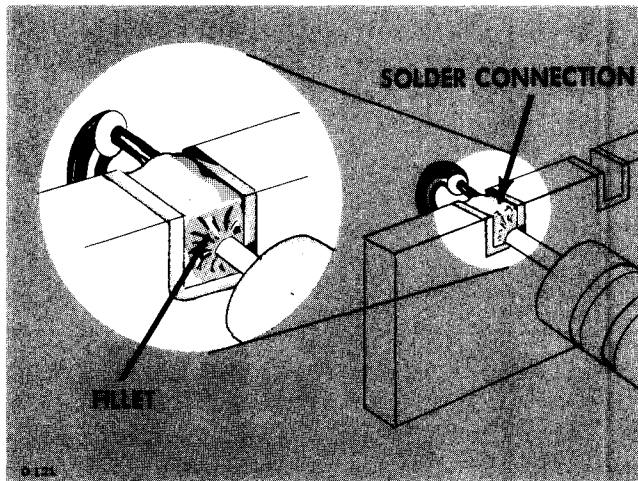

Fig. 4-3. A slight fillet of solder is formed around the wire when heat is applied correctly.

General Soldering Considerations

When replacing wires in terminal slots clip the ends neatly as close to the solder joint as possible. In clipping ends or wires take care the end removed does not fly across the room as it is clipped.

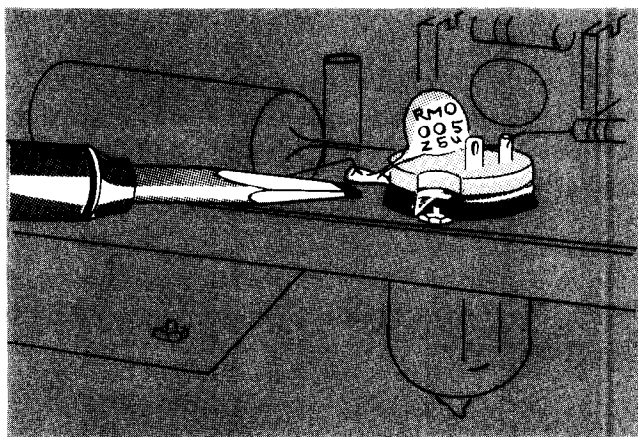

Fig. 4-4. Soldering to a terminal. Note the slight fillet of solder--exaggerated for clarity--formed around the wire.

Occasionally you will wish to hold a bare wire in place as it is being soldered. A handy device for this purpose is a short length of wooden dowel, with one end shaped as shown in Fig. 4-5. In soldering to terminal pins mounted in plastic rods it is necessary to use some form of "heat sink" to avoid melting the plastic. A pair of long-nosed

pliers (see Fig. 4-6) makes a convenient tool for this purpose.

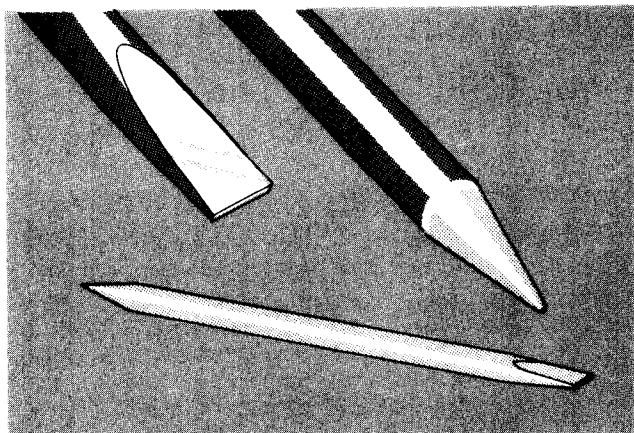

Fig. 4-5. A soldering aid constructed from a 1/4 inch wooden dowel.

Ceramic Strips

Two distinct types of ceramic strips have been used in Tektronix instruments. The earlier type mounted on the chassis by means of #2-56 bolts and nuts. The later type is mounted with snap-in plastic fittings. Both styles are shown in Fig. 4-7.

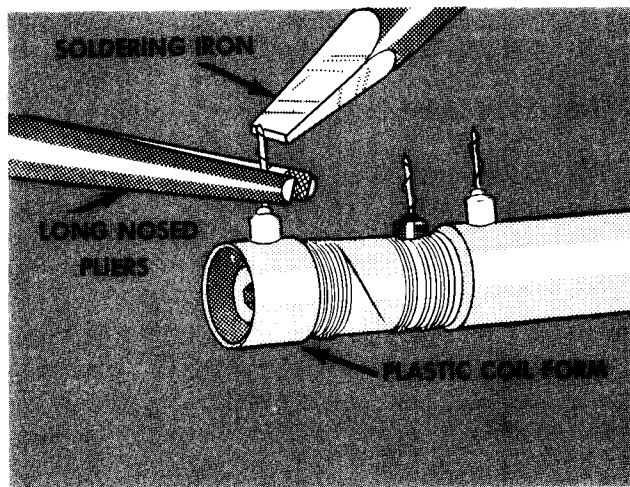

Fig. 4-6. Soldering to a terminal mounted in plastic. Note the use of the long-nosed pliers between the iron and the coil form to absorb the heat.

To replace ceramic strips which bolt to the chassis, screw a #2-56 nut onto each mounting bolt, positioning the nut so that the distance between the bottom of the nut and the bottom of the ceramic strip equals the height at which you wish to mount the strip above the chassis. Secure the nuts to the bolts with a drop of red glyptal. Insert the bolts through the holes in the chassis where

the original strip was mounted, placing a #2 starwasher between each nut and the chassis. Place a second set of #2 flatwashers on the protruding ends of the bolts, and fasten them firmly with another set #2-56 nuts. Place a drop of red glyptal over each of the second set of nuts after fastening.

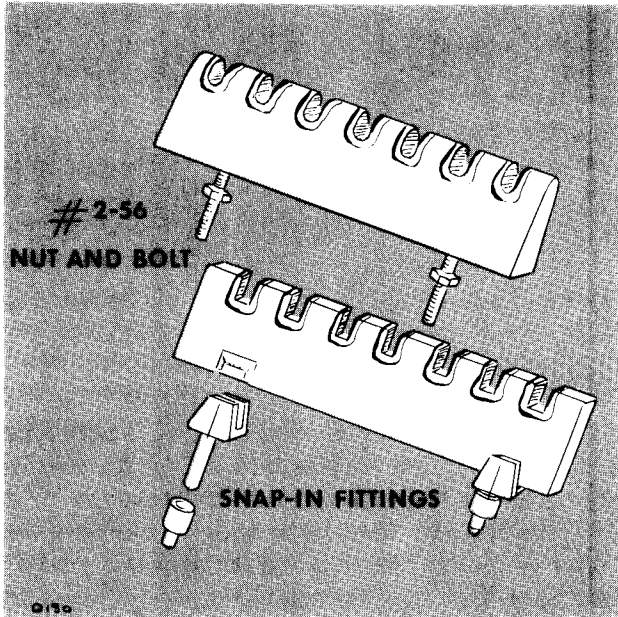

Fig. 4-7. Two types of ceramic strip mountings.

Mounting Later Ceramic Strips

To replace strips which mount with snap-in plastic fittings, first remove the original fittings from the chassis. Assemble the mounting post on the ceramic strip. Insert the nylon collar into the mounting holes in the chassis. Carefully force the mounting post into the nylon collars. Snip off the portion of the mounting post which protrudes below the nylon collar on the reverse side of the chassis.

Note

Considerable force may be necessary to push the mounting rods into the nylon collars. Be sure that you apply this force to that area of the ceramic strip directly above the mounting rods.

TROUBLESHOOTING

This section is included to provide you with information about the Type R Plug-In Unit that will enable you to more efficiently trouble-

shoot the instrument in the event of equipment failure. During troubleshooting work, you should correlate information contained in this section with information obtained from other sections of this manual. We have not attempted to give detailed step-by-step procedures for finding the cause of specific troubles. We have, instead, attempted to outline a general troubleshooting guide which can be used to locate any trouble which may occur in the instrument. This guide provides a means for determining the probable defective circuit or part from the symptoms observed rather than from detailed voltage or resistance measurements.

The Type R Unit can conveniently be thought of as a number of interrelated basic circuits as shown in the block diagram contained in the diagram section of the manual. Each of these circuits performs a specific part of the overall circuit operation required to display a transistor's switching characteristics on the associated oscilloscope. If any one of these circuits should fail, a definite symptom will be apparent. By investigating the possible causes of the symptom by means of systemized circuit checks, it is possible to determine which circuit or circuits are at fault. After locating the defective circuit, additional checks will isolate the trouble to a particular part.

Schematic diagrams of each circuit are contained in the rear portion of this manual together with a block diagram of the entire unit. The reference designation of each electronic component of the instrument is shown on the circuit diagrams as well as important voltages and waveforms. These voltages and waveforms may be used during troubleshooting to isolate the cause of the trouble.

All wiring in the Type R Unit is color coded to facilitate circuit tracing. Specific color codes are used to distinguish the leads for the power-supply voltages obtained from the oscilloscope. These power-supply leads follow the standard RETMA code. The -150 volts bus wire is coded brown-green-brown; the +350 volts bus is coded orange-green-brown; the +225 volts bus is coded red-red-brown and the +100 volts bus is coded brown-black-brown. The widest stripe identifies the first color of the code.

CIRCUIT ISOLATION

To display transistor switching characteristics, both the Type R Plug-In Unit and its associated oscilloscope must be operating properly. When a trouble occurs you must first determine whether the Type R Unit or the oscilloscope is at fault. This can best be determined by operating the Type R Unit with another oscilloscope and/or operating the oscilloscope with another plug-in unit. If neither another oscilloscope nor another plug-in unit is available, you must then check the operation of the oscilloscope's power supplies, vertical amplifier, and triggering circuits. When the trouble has been definitely determined to exist in the Type R Unit, additional steps then are required to isolate the defective circuit.

An apparent trouble in the Type R Unit may result from improper control settings, a defective test transistor, improper calibration, or an actual circuit defect. When an apparent trouble is detected, you must first check that the front-panel control settings are correct for the type of transistor being tested. If the controls are set correctly, substitute another test transistor and again check the operation of the unit. If operation of the unit remains essentially the same, it will then be necessary to check the calibration of the unit using the procedure given in the Recalibration section of this manual.

A calibration check will not only permit you to correct troubles due to improper calibration; but will also enable you to isolate the defective circuit should an actual trouble exist. If a trouble exists in the unit, you will reach an adjustment or check while going through the recalibration procedure where you obtain an abnormal indication. From the adjustment or check where the trouble first appears and from the indications obtained, you will be able to determine which circuit is defective, and also, in many cases, which portion of the defective circuit is at fault.

When you have determined which circuit is defective, you can then refer to the Circuit Troubleshooting procedures which follow where procedures are given for troubleshooting the individual circuits. If you recognize immediately which circuit is at fault when a trouble appears, you can proceed directly to the Circuit Troubleshooting information without using the recal-

ibration procedure to isolate the defective circuit. In such cases, however, you must be certain that the trouble cannot be corrected by recalibration before using the Circuit Troubleshooting information.

CIRCUIT TROUBLESHOOTING

This portion of the Troubleshooting Procedure contains information for locating a defective stage or part within a given circuit. Once the stage at fault is known, the component(s) causing the trouble can be located by tube and component substitution, by voltage and resistance measurements using the information contained on the schematic diagrams, or by continuity checks.

Tube failure is one of the most frequent causes of circuit failure. For this reason, the first step in troubleshooting is to check for defective tubes--preferably by direct substitution. Do not depend on tube testers to adequately indicate the suitability of a tube for use in the instrument. The criterion for usability of a tube is whether or not it works satisfactorily in the instrument. Be sure to return any tubes found to be good to their original sockets. If this procedure is followed, less recalibration of the instrument will be required upon completion of the servicing.

If the replacement of a defective tube does not correct the trouble, then check that components which are associated with the tube have not been damaged. Shorted tubes will often overload plate-load and cathode resistors. These components can usually be checked by a visual inspection of the circuit. If no damaged components are apparent, however, it will be necessary to make measurements or other checks within the circuit to locate the trouble.

Transistors used in the Type R Unit are quite reliable unless their ratings are exceeded. In most cases, the failure of a transistor will be due to a defect in some component associated with the transistor rather than to a defect in the transistor itself. A component failure may cause the transistor ratings to be exceeded thereby damaging the transistor. It is extremely important, therefore, that you thoroughly check the circuit associated with the transistor before connecting a new transistor into the circuit. If a new transistor is connected into the circuit before proper precautions are taken, the new transistor may also be damaged.

Collector Power Supply

Trouble occurring in the collector supply will generally produce one of the following indications at the output of the power supply: (1) no output voltage, (2) abnormally high output voltage which is not variable, (3) output voltage which is variable but not within the proper limits, or (4) excessive ripple voltage. These troubles are discussed separately in the following paragraphs.

Normal power supply voltages are shown on the schematic diagram of the power supply. If the voltages are measured with respect to ground, readings obtained with the COLLECTOR SOURCE VOLTS switch in the PNP position will differ considerably from readings obtained with the switch in the NPN position. For this reason, it is recommended that all power-supply voltage measurements, except the output voltage measurements, be taken with respect to the emitter of Q6832 rather than with respect to ground. When voltage measurements are taken with respect to the emitter of Q6832, readings obtained will be the same regardless of the position of the COLLECTOR SOURCE VOLTS switch.

If no output voltage is obtained from the collector power supply, voltage checks should be made at the secondary winding of the transformer T6830, across capacitor C6832, and across series regulator transistor Q6837. The results of these readings will usually indicate the cause of the trouble. If either the voltage at the secondary winding of T6830 or the voltage across C6832 is abnormal, T6830, D6832A, D6832B, and C6832 should be checked.

A voltage reading across Q6837 approximately equal to the voltage measured across C6832 indicates that the series regulator is cut off. In such a case, no output voltage is a direct result of a lack of conduction by Q6837. However the reason that Q6837 is cut off may be due to a trouble existing in any one of the three transistor stages. To determine which stage is defective, check the collector- and the emitter-to-base voltages of transistors Q6837, Q6833, and Q6832. Under a condition of no output voltage, the amplifier stages should be attempting to cause the series regulator to conduct. This can be determined from the voltage readings.

If the output of the power supply is zero, Q6833 should be conducting heavily and Q6832 should be virtually cut off. This is the condition required to lower the base voltage of the series regulator, thereby causing the series regulator to conduct. Whether the transistors are conducting or cut off can be determined by checking the emitter and collector voltages and by checking the voltage drop across each transistor.

If the output voltage of the collector power supply is well above the normal upper-voltage limit and is not variable, series regulator Q6837 is conducting heavily. Heavy conduction of this sort may result from a failure of any stage in the circuit. The defective stage can be isolated by checking the operating voltages of Q6832, Q6833 and Q6837 in that order.

When the output voltage of the power supply is higher than normal, transistor Q6832 should be conducting heavily and transistor Q6833 should be nearly cut off for the proper correction voltage to be applied to the base of the series regulator. If the conduction stage of either one of these transistors is reversed from what it should be, the voltage applied to the base of the series regulator will tend to make the series regulator conduct more, rather than less. Checks on the emitter-to-collector voltages for transistors Q6832 and Q6833 will allow you to determine whether they are conducting or are cut off.

When the output voltage of the collector power supply is variable, this indicates that both the amplifier circuits and the series regulator are functioning. The output voltage of the power supply is relatively independent of changes in value occurring in the collector resistor of Q6832 or in the emitter resistor of Q6833. It is therefore unlikely that a change in the value of either R6834 or R6833 would change the voltage limits of the power supply. Resistors R6840, R6841, R6842, R6843, and R6838 determine the operating point and the output voltage limits of the power supply. Consequently, a change in value of one of these resistors would affect the voltage limits of the power supply.

Excessive ripple voltage is usually caused by defective capacitors. Consequently, capacitors C6832, C6840 and C6845 would be checked first. If the capacitors appear to be good, check the primary voltage of T6830. This

voltage should be within 6.3 +or- 0.6 volts for the power supply to regulate properly.

Floating Power Supply

The floating power supply is identical in operation to the collector power supply. Consequently, the same types of troubles will occur and the same general troubleshooting techniques may be employed. Since the floating power supply is ungrounded and is riding on the output voltage of the bias power supply, it is doubly important that all voltage measurements be made with respect to some fixed point in the circuit rather than with respect to ground. If voltage measurements are made with respect to the emitter voltage of Q6854, readings obtained will be the same regardless of the position of the PULSE VOLTS Polarity switch or the setting of the BIAS VOLTS controls.

Bias Power Supply

The bias power supply is somewhat different in operation from either the collector power supply or the floating power supply in that two sets of rectifiers and two series regulators are used to allow the voltage to vary continuously between +5 and -5 volts. Troubles occurring in the bias power supply, however, do correspond to troubles which occur in the other power supplies. Troubles usually consist of a lack of regulation, unvariable output voltage, improper output voltage limits, or excessive ripple voltage. Checks made on the supply to determine the cause of these troubles should be made with a load on the output.

In the bias power supply, a lack of regulation generally occurs simultaneously with an unvariable output voltage. This is because the same circuitry is involved in maintaining regulation as is involved in adjusting the output voltage. Both troubles are usually due to a failure of one of the transistor stages.

In adjusting the output voltages or in maintaining regulation, Q6884 acts as the sensing stage for the power supply. That is, Q6884 detects the difference (error signal) between the desired output voltage and the actual output voltage. The error signal is then applied to the series regulators to adjust the output of the power supply to the correct level. The conduction of Q6884 is controlled by both

the setting of the BIAS VOLTS controls and by the output voltage of the power supply. Transistor Q6884 controls the operation of the other transistors in the circuit. If the power supply is not regulating, it is because one of the stages is not responding properly to the error signals. The defective stage could be any one of those located in the power supply. From the conditions of the output voltage, it is possible to predict how each stage should react to the error. When this has been established, you should then check the operation of each stage, starting with Q6884. The conduction of each stage can be determined by measuring the emitter to collector voltage of each transistor. When a stage is checked where the transistor is conducting heavily when it should be cut off or is cut off when it should be conducting heavily, this will serve to isolate the defective stage.

The voltage limits for the power supply are determined by the resistors in the base circuit of Q6884. If the power supply seems to be operating normally except that the output voltage limits have shifted slightly, the resistors in the base circuit of Q6884 should be checked first. It is possible for you to reduce the number of resistors you must check by observing operation of the power supply with the BIAS VOLTS red knob in both the X1 and X10 positions.

Excessive ripple voltage at the output of the bias power supply is usually due to defective filter capacitors. If all the filter capacitors appear to be in good condition, the secondary voltage of T6830 should be checked against the figure given on the schematic diagram.

Pulse Generator

A trouble occurring in the pulse generator section of the Type R Unit will affect the pulse applied to the transistor being tested. If the trouble occurs in only one of the positions of the PULSE VOLTS or SERIES RESISTOR switches, the trouble is probably a defective resistor or switch. In such a case the resistors used in the position of the switch where the trouble occurs should be checked.

Note

The mercury switch, SW5803, will not operate properly unless the Type R Unit is in the upright position.

Troubles which occur in all positions of the PULSE VOLTS and SERIES RESISTOR switches will usually be due to improper operation of the mercury switch although mis-adjustment of coils L5804 and L5812 will affect the risetime of the pulse in all positions of the switches. The output of the mercury switch can be observed on the associated oscilloscope by depressing the PULSE ZERO TIME REFERENCE switch. If the mercury switch is not operating, no output will be obtained. Mechanical operation of the switch can be checked by listening for the buzzing sound which accompanies operation of the switch. If no buzzing sound is heard, the solenoid, L5803, and rectifier D5803 must be checked.

If the mercury switch buzzes but no output pulses are obtained, the contacts are probably defective. Only one of the two sets of contacts contained in the switch are normally used. Consequently, before replacing the mercury switch you should check operation of the pulse generator using the second set of contacts.

Trigger Circuit

Troubles occurring in the trigger circuit can most easily be isolated by using a test oscilloscope to check the waveform at various points in the circuit against the waveforms shown on the schematic diagram. The circuit should be checked first with the TRIGGER switch in the SINGLE position. In single triggered operation, the circuit operates essentially as an amplifier thereby providing a relatively easy means for checking circuit operation.

If the circuit fails to operate correctly with the TRIGGER switch in the DOUBLE position, the trouble is probably either C5824, V5844 or V5833. After checking each of these components, you should then check the components associated with V5833 and V5844. The defective components can be detected by voltage and resistance measurements using the information given on the schematic diagram.

Preamplifier Circuit

Troubles occurring in the preamplifier circuit in some but not all positions of the COLLECTOR CURRENT MA/CM switch will usually be due either to a defective resistor or switch. The defective part can be isolated by checking

components which are common to the switch positions in which the trouble exists.

If a trouble occurs in all positions of the COLLECTOR CURRENT MA/CM switch, three conditions could exist which would cause the trouble. The transistor under test could be defective, resistors R5850A and R5850B could be off value or open, or the amplifier stages could be malfunctioning. By depressing the PULSE ZERO TIME REFERENCE switch, the trouble can be partially isolated to one of these areas of possible trouble.

With SW5880 depressed, the output of the pulse generator circuit should be displayed on the associated oscilloscope. If this waveform appears normal in every respect, this serves as a check on operation of the amplifier stages and the vertical positioning circuit. You can then be certain that the trouble lies somewhere ahead of the amplifier. By releasing SW5880 and depressing SW5870, the vertical positioning circuit can be further checked. The cause of troubles occurring in either the vertical positioning circuit or the collector circuit of the test transistor can be found by voltage and resistance measurements.

Troubles which are most commonly found in the amplifier stages are insufficient gain, amplifier unbalance, or waveform distortion. These troubles may occur either simultaneously or separately.

Very few troubles which may occur in the amplifier stages will produce a lack of gain without also affecting amplifier balance. However, if such a trouble does exist, you should check components which are common to both sides of the amplifier circuit such as common cathode resistors, plate dropping resistors, or screen dropping resistors. If these components appear to be in good condition, it will be necessary for you to select tubes which will provide the proper amplifier gain and unbalance. You can check the amplifier for proper gain by using the calibrator signal from the oscilloscope used in conjunction with the Type R Unit. To do this, connect .2 volt of calibrator signal to the 1 MEG 15 $\mu\mu$ F SCOPE INPUT connector and depress switch SW5870. If the gain of the amplifier stages is correct, there should be 2 centimeters of vertical deflection on the oscilloscope.

Amplifier unbalance is indicated if the electron beam is deflected off the crt screen or if the position control does not have sufficient range to position the spot off both the bottom and the top of the screen. The oscilloscope beam position indicators can be used to aid in determining if the amplifier is unbalanced.

Amplifier unbalance results from troubles which affect only one side of the amplifier or which affect one side more than the other. Tubes are the most common cause of unbalance, and they should be checked first. If tubes are changed in the amplifier stages, it will usually be necessary for you to readjust R5885 and the HF PEAKING control (see the Recalibration Procedure).

The stage producing amplifier unbalance can be isolated by using a shorting jumper. After placing the POSITION control at mid range, connect the jumper between pins 1 and 3 of the 16-pin interconnection plug located at the rear of the Type R Unit. With these pins shorted together, the trace should appear on the oscilloscope screen. If the trace does not appear, the trouble is located in the oscilloscope rather than in the Type R Unit.

If the trace does appear on the oscilloscope when pins 1 and 3 of the interconnecting plug are shorted together, the jumper should then be placed successively between corresponding points on opposite sides of the amplifier. As you short between each pair of points, in turn, you should see the trace return to the screen as the connection is made. When you reach a point in the circuit where the trace does not return to the screen, the stage or components immediately following that point are at fault. The specific cause of the unbalance in the stage can then be determined by voltage and resistance measurements.

Waveform distortion occurs most generally as a result of a misadjustment of the HF PEAKING control. This trouble can be corrected quickly using the procedure contained in the Recalibration section of the manual. Waveform distortion also occurs less frequently due to various tube conditions and to failures of peaking coils L5884 and L5894. Consequently, if adjustment of the HF PEAKING control does not completely correct the waveform distortion, the amplifier tubes and the peaking coils should be checked.

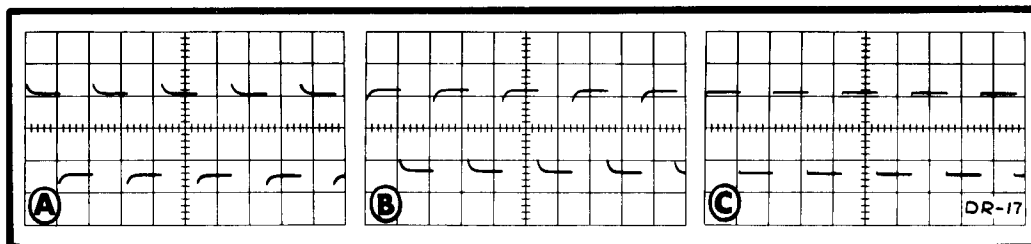
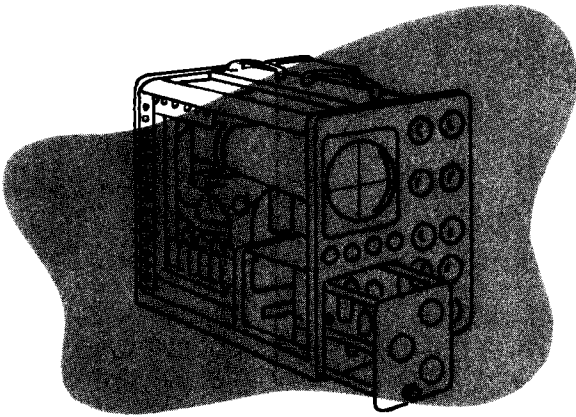

Fig. 4-8. Two types of high-frequency distortion. In waveform A, excessive boost of the high-frequency components of the square-waves results in the overshoot shown. In waveform B, the high-frequency components of the square-waves are attenuated resulting in undershoot. Waveform C is normal.

CALIBRATION PROCEDURE



INTRODUCTION

Information contained in this section is provided as an aid to recalibrating and checking the operation of the Type R Plug-In Unit. In addition, this section may be used to isolate troubles occurring within the unit.

Apparent troubles in the unit are often the result of improper calibration of one or more circuits. Consequently, calibration checks should be an integral part of any troubleshooting procedure. Abnormal indications occurring during calibration checks will often aid in isolating troubles to a definite circuit or stage.

In the instructions that follow, the steps are arranged in the proper sequence for a complete recalibration of the instrument. Each numbered step contains the information required to make one check, one adjustment, or a series of related adjustments or checks. The steps are arranged so that unnecessary repetition of certain checks is avoided.

In each recalibration step only the required information is given. Detailed instructions pertaining to normal operation of the instrument are not included. If you are in doubt as to the proper operation of controls, refer to the Operating Instructions.

Controls not mentioned in a particular recalibration step are assumed to be in the positions they were in during the previous step. All test equipment used in any particular step should be disconnected at the end of the step unless you are instructed to the contrary.

If a single control requires adjustment, it can be adjusted in the applicable step of this procedure without performing other steps as well. It will be necessary, however, that you refer to the recalibration steps immediately

preceding the adjustment you wish to make to determine the proper settings for the controls not mentioned in that step.

If you suspect that the unit is out of calibration but you are not aware of which particular adjustment will correct the difficulty, it is usually best to run through the entire recalibration procedure. In this way you can be certain that the unit is properly calibrated without resorting to a method of random experimentation.

EQUIPMENT REQUIRED

The following equipment or its equivalent is required to perform a complete recalibration of the Type R Plug-In Unit.

1. Tektronix 540-Series convertible oscilloscope.
2. Oscilloscope with calibrated vertical deflection factors such as the Tektronix Type 316. It is necessary that the test oscilloscope have calibrated vertical deflection factors between 0.01- and 10-volts per division.
3. DC voltmeter with sensitivity of at least 20,000-ohms per volt.
4. Ohmmeter.
5. Short risetime square-wave generator, Tektronix Type 107. If a Tektronix Type 107 Square-Wave Generator is not available, it will be necessary to substitute a square-wave generator or pulser with a risetime of less than 3 nanoseconds.
6. Tektronix Type P52 Coaxial Cable, 52-ohms characteristic impedance.
7. Tektronix Type B52-R, 52 ohm Terminating Resistor.

8. Test resistor, 35 ohms, 10 watts.
9. Test resistor, 50 ohms, 5 watts.
10. Coaxial adapter, Tektronix Part Number 016-011.
11. Grounded-emitter transistor board, Tektronix Part Number 386-852, with a 220-ohm collector load resistor, RL.
12. Flexible plug-in extension, Tektronix Part Number 012-038.
13. Plug-In extension, Tektronix Part Number 013-015.
14. Type 2N544 transistor.
15. Miscellaneous alignment tools. (See Figure 5-1).

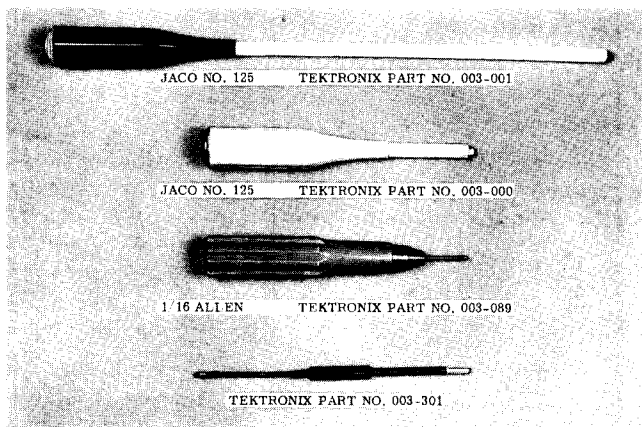

Fig. 5-1. Suggested alignment tools for recalibrating the Type R Plug-In Unit.

PROCEDURE

Preliminary

Make a careful visual check of the unit. Check the resistance to ground from those pins on the interconnecting plug listed in the table below. Readings obtained should be approximately equal to those listed.

Using the ohmmeter, check each of the resistors on the SERIES RESISTOR and COLLECTOR CURRENT MA/CM switches for proper value. (This is only a rough check since most ohmmeters do not have sufficient accuracy to make a fine check. If for some reason a resistor is suspected of being out

of tolerance, it will be necessary to use a precision ohmmeter or resistance bridge to make an accurate check.)

RESISTANCES TO GROUND AT INTERCONNECTING PLUG

PIN NUMBER	RESISTANCE
1	9 kilohms
3	9 kilohms
9	5 kilohms
10	1.9 kilohms
11	6.5 kilohms
12	Infinite
13	Infinite
14	Infinite
15	75 ohms

Using the flexible plug-in extension, connect the R Unit to the 540-Series oscilloscope. Turn on the oscilloscope power.

1. Collector Power Supply

Place the COLLECTOR SOURCE VOLTS polarity switch in the NPN+ position and measure the voltage from the collector of Q6837 to ground while rotating the COLLECTOR SOURCE VOLTS control. The voltage readings should vary smoothly between approximately -8.8 volts and approximately -22 volts. Measure the voltage across C6847 while again rotating the COLLECTOR SOURCE VOLTS between its limits. The voltage should vary approximately between +1 and +15 volts with the polarity switch in the NPN+ position.

2. Floating Power Supply

Place the PULSE VOLTS Polarity switch in the + position and rotate R6859 fully clockwise. Measure the voltage from the collector of Q6857 to the floating chassis (shield over the PULSE VOLTS switch) while rotating the variable PULSE VOLTS control. The voltage should vary approximately between -4.2 and -10.8 volts.

3. Bias Power Supply

Measure the voltage from the collector of Q6877 and from the emitter of Q6887 to ground. The voltage at the collector of Q6877 should be approximately -10 volts and the voltage at

the emitter of Q6887 should be approximately +10 volts. Place the BIAS VOLTS red knob in the X10 position and measure the voltage from the floating chassis to ground while rotating the BIAS VOLTS black knob. The voltage should vary approximately between +5 and -5 volts. Place the BIAS VOLTS red knob in the X1 position and again check the voltage from the floating chassis to ground while rotating the BIAS VOLTS black knob. The voltage should vary approximately between +0.5 and -0.5 volt.

6. Microphonic Tubes

Free-run the oscilloscope sweep and position the trace near the center of the screen. Rap lightly with the palm of the hand on the top of the R Unit and check for excessive microphonics by watching the trace on the oscilloscope. If a microphonic tube is indicated, lightly tap each tube individually to isolate the defective one.

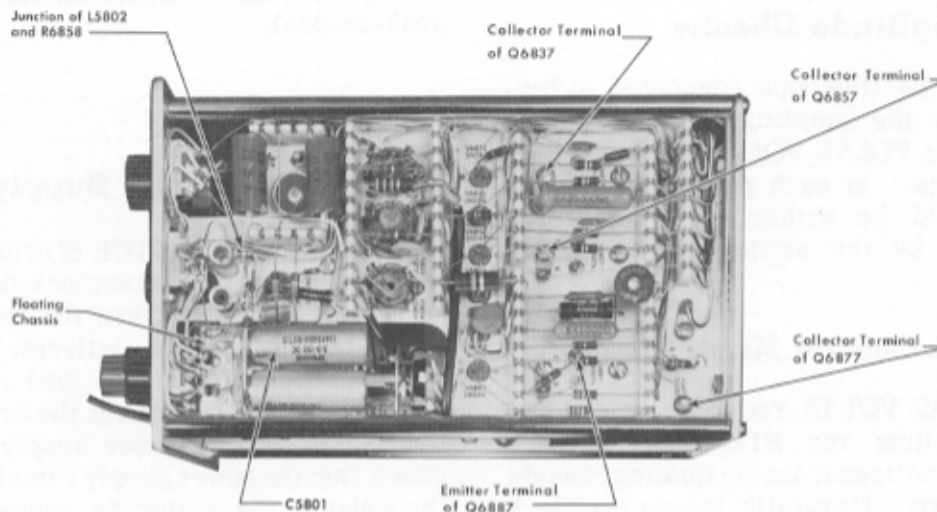

Fig. 5-2. Location of power supply test points.

4. Pulse Volts Adjust (R6859)

Place the BIAS VOLTS red knob in the X1 position and adjust the BIAS VOLTS black knob so that the voltage from the floating chassis to ground is zero. Connect the input of the test oscilloscope to transistor mounting terminal B. Rotate the PULSE VOLTS VARIABLE control fully clockwise and place the PULSE VOLTS switch in the 10 position. Connect the dc voltmeter across capacitor C5801 and adjust R6859 for a +or- 10 volt reading. Check the amplitude of the pulses generated by the mercury pulser. The pulses displayed on the test oscilloscope should have a peak amplitude of 10 volts.

5. Amplifier DC Level

Set the POSITION and POSITION RANGE ADJ. controls at mid range. Measure the voltage at pins 1 and 3 of the interconnecting plug to ground. Both voltage readings should be between 65 and 70 volts.

7. Position Range Adj.

Set the POSITION control to mid range and place a jumper between pins 1 and 3 of the interconnecting plug. Observe the position of the trace on the oscilloscope screen with the jumper in place. Remove the jumper and adjust the POSITION RANGE ADJ. control to position the trace to the same point as observed previously with the jumper in place.

8. Gain Adj. (R5885)

Connect 200 millivolts of Calibrator signal from the oscilloscope to the transistor mounting terminal marked 1 MEG 15 $\mu\mu\text{F}$ SCOPE INPUT. Depress the PUSH TO CONNECT SCOPE INPUT TO THIS TERMINAL switch and adjust R5885 for exactly 2 centimeters of vertical deflection on the oscilloscope screen.

9. Collector Source Volts Control Tracking

Connect the dc voltmeter from the transistor

mounting terminal C to ground. Check the voltmeter readings against the settings of the COLLECTOR SOURCE VOLTS control as the control is rotated throughout its range. The voltmeter readings should agree closely with the settings of the COLLECTOR SOURCE VOLTS control throughout the range of the control. However, slight error will occur at the extreme clockwise and counterclockwise positions of the control. The tracking should be equally good for either NPN+ or PNP- positions of the COLLECTOR SOURCE VOLTS Polarity switch.

10. Pulse Amplitude Checks

With the test oscilloscope connected to terminal B, check the amplitude of the pulses obtained with the PULSE VOLTS switch in each of its 8 positions. In each position, the pulse amplitude should be within +or- 3% of the value indicated by the setting of the PULSE VOLTS switch.

11. Bias Volts Control Knob Position

Place the BIAS VOLTS red knob at the X10 position and adjust the BIAS VOLTS black knob so that the voltage from the floating chassis to ground is zero. Carefully loosen the black BIAS VOLTS knob and rotate it without rotating the shaft until the dot is at the zero marking. Carefully retighten the knob on the shaft. The voltage from the floating chassis to ground should remain at zero as the BIAS VOLTS red knob is switched from the X10 to the X1 position.

12. Bias Power Supply Regulation

Set the BIAS VOLTS controls at zero and X10. Connect the probe from the test oscilloscope to the floating chassis and connect the dc voltmeter from the floating chassis to ground. Place the 35-ohm test load resistor from the floating chassis to ground and slowly rotate the BIAS VOLTS black knob in the clockwise direction. The power supply should regulate over the complete range of the BIAS VOLTS black knob. (the test-oscilloscope display will indicate when the power supply goes out of regulation.) Remove the test resistor and observe the ripple voltage displayed on the test oscilloscope. The ripple voltage should be approximately 2.5 millivolts, peak-to-peak.

13. Floating Power Supply Regulation

Place the PULSE VOLTS red knob in the fully counterclockwise position and connect the probe from the test oscilloscope to the output of the Floating Power Supply. Connect the dc voltmeter and the 50-ohm test load resistor across capacitor C5801 (see Figure 5-2). Check that the power supply continues to regulate through the 3.8 v range of the PULSE VOLTS VARIABLE control. Remove the test resistor and check the ripple voltage displayed on the test oscilloscope. The ripple voltage should be approximately 3 millivolts, peak-to-peak.

14. Collector Power Supply Regulator

Place the COLLECTOR SOURCE VOLTS control in the fully counterclockwise position and connect the probe from the test oscilloscope to the output of the Collector Power Supply. Connect the 35-ohm test load resistor across capacitor C6847. Connect the dc voltmeter from the output of the power supply to ground and check that the power supply remains in regulation throughout the complete range of the COLLECTOR SOURCE VOLTS control. Remove the test resistor and check the ripple voltage displayed on the test oscilloscope. The ripple voltage should be approximately 2 millivolts peak-to-peak.

15. Amplifier HF Compensation

Disconnect the flexible plug-in extension and install the Type R Unit in the plug-in compartment of the oscilloscope. Connect the output of the Type 107 Square-Wave Generator through the 52-ohm cable and 52-ohm terminating resistor to the 1 MEG 15 $\mu\mu\text{F}$ SCOPE INPUT connector on the front panel of the Type R Unit using the special coaxial adapter. Depress the PUSH TO CONNECT SCOPE INPUT TO THIS TERMINAL switch and adjust the output of the square-wave generator to obtain approximately 3 centimeters of vertical deflection on the oscilloscope. Set the Type 107 frequency control to obtain 400-kc square-waves. Adjust the oscilloscope to trigger on the rising portion of the square-wave and adjust the sweep rate for 0.5 μsecond per centimeter sweeps. Adjust the HF PEAKING control to obtain the best possible square-wave response. (See Figure 5-3).

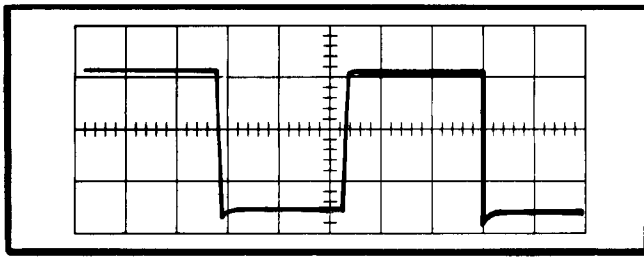

Fig. 5-3. Adjustment of the HF PEAKING control. The illustration above shows the typical waveform obtained with the correct setting of the HF PEAKING control.

16. Positive-Step Response (L5804)

Remove the Type R Unit from the plug-in compartment of the oscilloscope, insert the short plug-in extension, and re-insert the R Unit in the plug-in compartment. Adjust the slugs of L5804 and L5812 so that the tops of the slugs are even with the tops of the coils. Connect the TRIGGER OUT cable to the TRIGGER INPUT connector of the oscilloscope and adjust the oscilloscope for external triggering. Place the COLLECTOR SOURCE VOLTS switch in the PNP- position and set the PULSE VOLTS controls to -, 2, and CALIBRATED. Turn both BIAS VOLTS controls fully clockwise and set the COLLECTOR

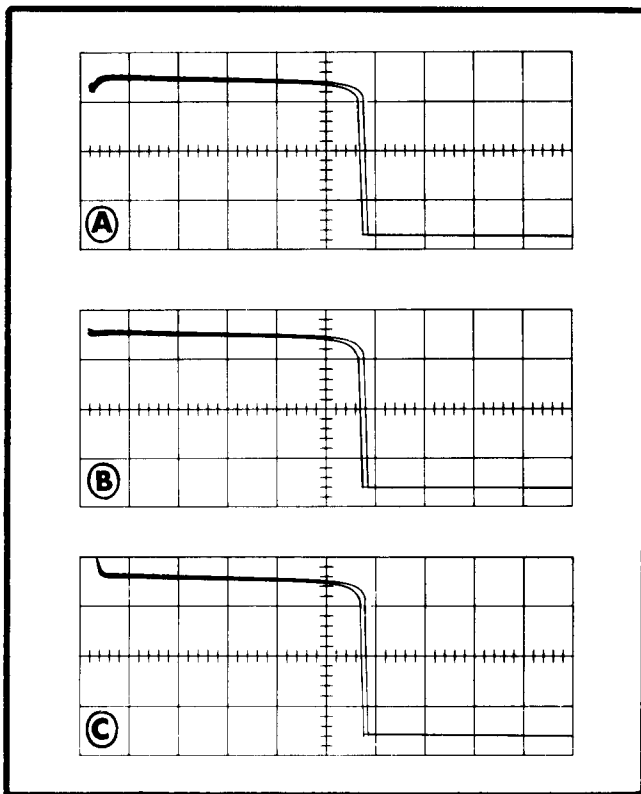

Fig. 5-4. Adjustment of L5804. Using a type 2N544 test transistor, L5804, is adjusted for the waveform shown in illustration B above. Waveforms A and C show typical waveforms obtained with a misadjustment of L5804.

SOURCE VOLTS control at 3. Place the COLLECTOR CURRENT MA/CM switch in the .5 (200 Ω) position and the SERIES RESISTOR switch to 50 Ω . Set the oscilloscope sweep speed to 100 μ seconds per centimeter and readjust the oscilloscope controls to obtain stable triggering. Install a grounded-emitter transistor mounting board, using a 2N544 or equivalent transistor, on the front of the R Unit. Turn the BIAS VOLTS control slowly counterclockwise until approximately 3 centimeters of vertical deflection are obtained on the oscilloscope with the BIAS VOLTS black knob in the + region. Adjust L5804 for the best possible square-wave display on the oscilloscope while observing the top of the leading edge of the displayed pulse. (See Figure 5-4).

17. Negative-Step Response (L5812)

Leave all controls and test conditions as they were at the completion of Step 16. Place the BIAS VOLTS red knob in the X1 position and adjust the BIAS VOLTS black knob slowly counterclockwise into the - region until approximately 3 centimeters of vertical deflection are obtained. Adjust L5812 to reduce the spike at the bottom of the trailing edge of the displayed pulse to a minimum. (See Figure 5-5).

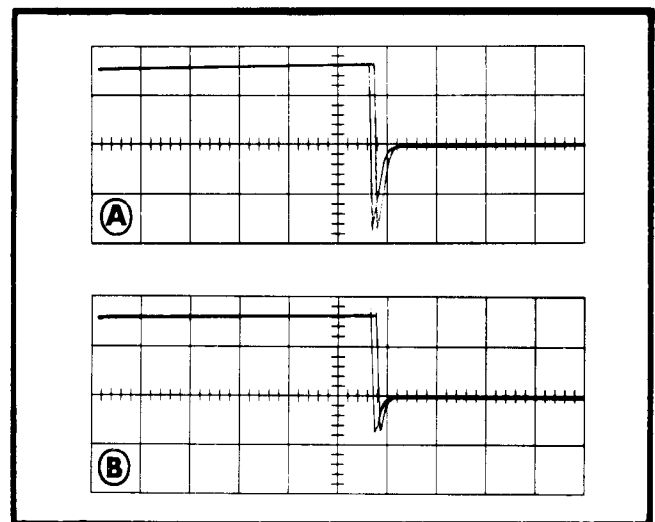

Fig. 5-5. Adjustment of L5812. Using a type 2N544 test transistor, L5812 is adjusted for a minimum of spiking on the falling portion of the pulse. A typical waveform obtained with the correct setting of L5812 is shown in illustration B. Waveform A results from a misadjustment of L5812.

18. Measuring Risetime

Remove the short plug-in extension and install the R Unit in the plug-in compartment of the oscilloscope. Remove the transistor mounting

board and jumper between terminals B and C on the front of the unit using as short a jumper wire as is possible. Connect the TRIGGER OUT cable to the oscilloscope TRIGGER INPUT connector and adjust the oscilloscope for stable triggering. Adjust the PULSE VOLTS controls for 2 centimeters of vertical deflection and set the PULSE VOLTS Polarity switch at +. Set the oscilloscope sweep rate to $.1 \mu\text{second}$ per centimeter and the sweep magnifier to 5X. Observe the points on the rising portion of the displayed pulse where the vertical deflection is 2 millimeters from the bottom of the pulse and 2 millimeters from the top of the pulse (see Figure 5-6). These two points are

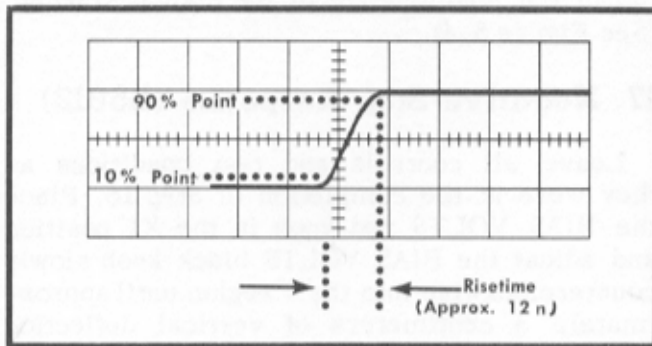

Fig. 5-6. Measurement of the risetime of the Type R Unit and associated oscilloscope.

the 10% and 90% points on the rising portion of the pulse. The horizontal distance between these two points multiplied by the oscilloscope sweep-rate is the risetime of the system. (The system includes the Type R unit Pulser and Preamplifier and the oscilloscope vertical-deflection system.) The risetime of the system should be approximately 12 nanoseconds.

Note

For more accurate risetime measurements, check the timing of the portion of the sweep used for these measurements with 50 megacycle sine waves obtained from an accurate source.

19. Trigger Circuit Operation

With all controls set as in the previous step, place the TRIGGER switch in the DOUBLE position. Place the jumper between terminals B and C. You should then be able to observe both rising and falling portions of the pulser waveform. (It may be necessary to slightly readjust the oscilloscope STABILITY and TRIGGERING LEVEL controls to obtain this result.)

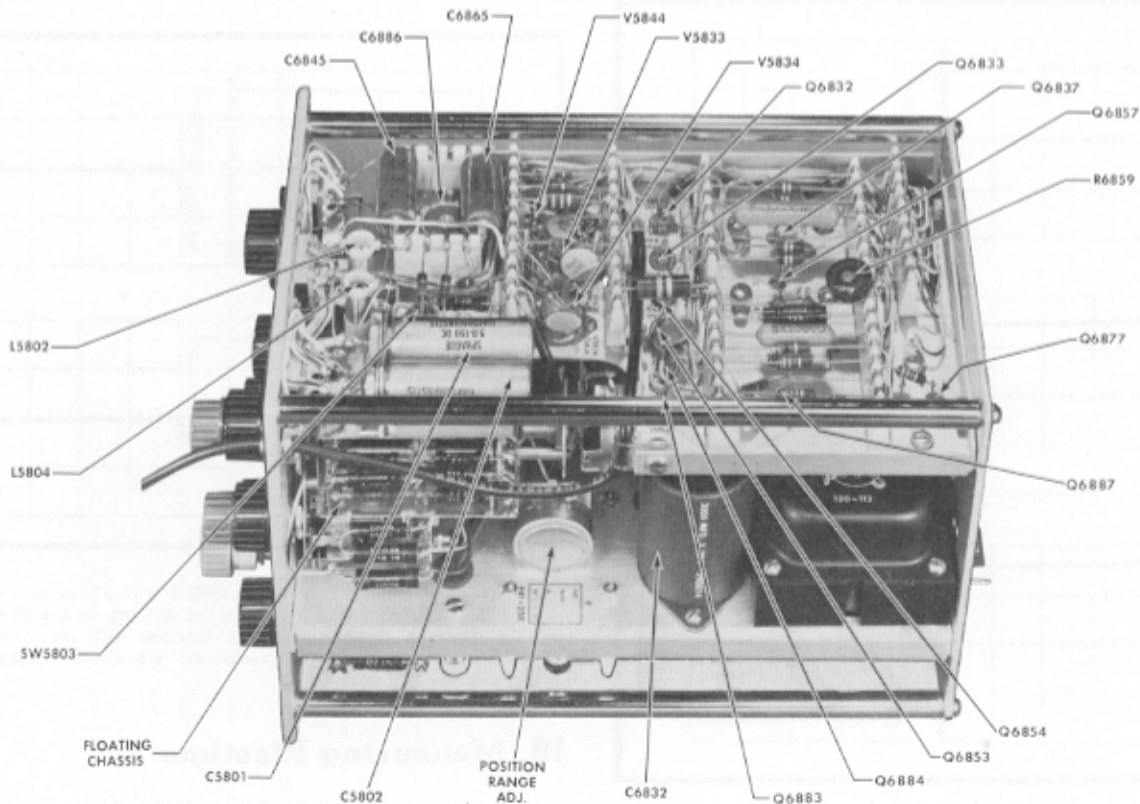

Fig. 5-7. Top and right side views of the Type R Unit.

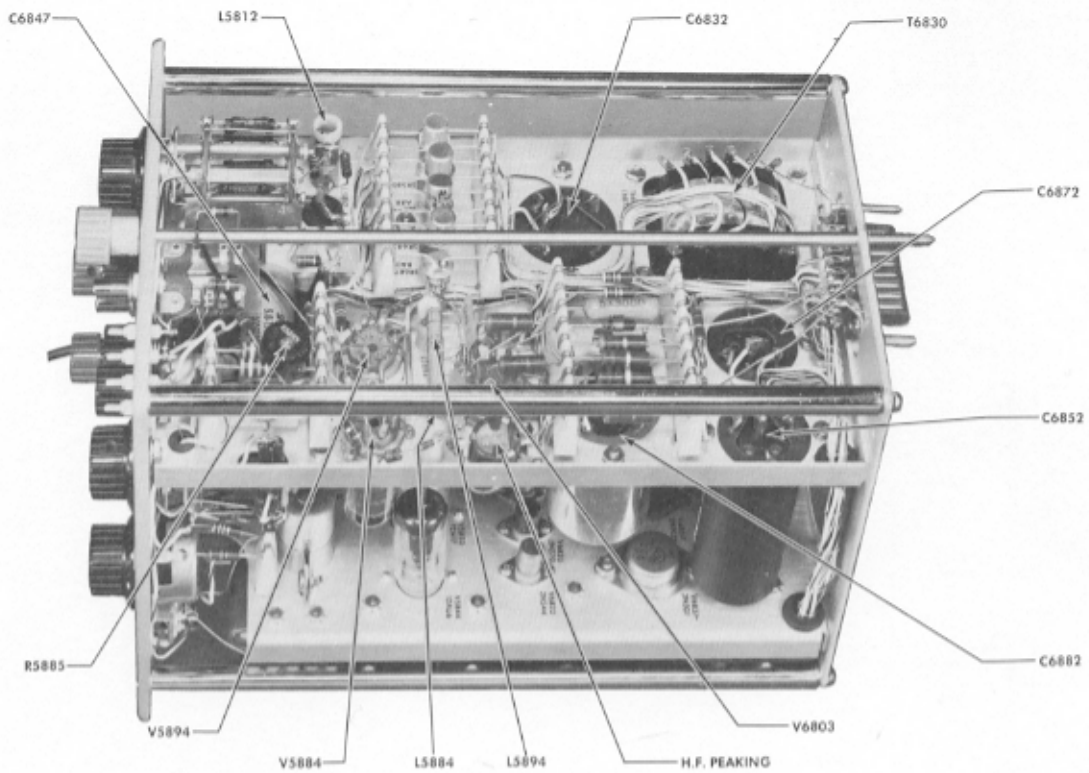

Fig. 5-8. Bottom and left side view of the Type R Unit.

PARTS LIST *and*

DIAGRAMS

Part No.	Description	Quantity	Notes
100-0000
100-0001
100-0002
100-0003
100-0004
100-0005
100-0006
100-0007
100-0008
100-0009
100-0010
100-0011
100-0012
100-0013
100-0014
100-0015
100-0016
100-0017
100-0018
100-0019
100-0020
100-0021
100-0022
100-0023
100-0024
100-0025
100-0026
100-0027
100-0028
100-0029
100-0030
100-0031
100-0032
100-0033
100-0034
100-0035
100-0036
100-0037
100-0038
100-0039
100-0040
100-0041
100-0042
100-0043
100-0044
100-0045
100-0046
100-0047
100-0048
100-0049
100-0050

Cer.
Comp.
EMC
f
G
GMV
h
K or k
M/Cer.
M or meg
μ
m

ABBREVIATIONS

Ceramic	n	Nano or 10 ⁻⁹
Composition	Ω	ohm
Electrolytic, metal cased	p	Pico or 10 ⁻¹²
Farad	PTB	Paper, "Bathtub"
Giga, or 10 ⁹	PMC	Paper, metal cased
Guaranteed minimum value	Poly.	Polystyrene
Henry	Prec.	Precision
Kilohms or kilo (10 ³)	PT	Paper Tubular
Mica or Ceramic	T	Terra or 10 ¹²
Megohms or mega (10 ⁶)	v	Working volts DC
Micro, or 10 ⁻⁶	Var.	Variable
Micromicro or 10 ⁻¹²	w	Watt
mili or 10 ⁻³	WW	Wire-wound

SPECIAL NOTES AND SYMBOLS

+ and up
 † Approximate serial number.
 X000 Part first added at this serial number.
 000X Part removed after this serial number.
 * 000-000 Asterisk preceding Tektronix Part Number indicates manufactured by or for Tektronix, also reworked or checked components.
 (Mod. w/) Simple replacement not recommended.
 Modify to value for later instruments and change other parts to match.



MANUFACTURERS OF CATHODE-RAY OSCILLOSCOPES

HOW TO ORDER PARTS

Replacement parts are available through your local Tektronix Field Office.

Improvements in Tektronix instruments are incorporated as soon as available. Therefore, when ordering a replacement part it is important to supply the part number including any suffix, instrument type, serial number, plus a modification number where applicable.

If the part you have ordered has been improved or replaced, your local Field Office will contact you if there is a change in part number.

PARTS LIST

Values are fixed unless marked Variable.

Capacitors

Circuit No.	Tektronix Part No.		Description			Serial No.
Tolerance $\pm 20\%$ unless otherwise indicated.						
Tolerance of all electrolytic capacitors are as follows (with exceptions):						
3 V— 50 V	—10% +250%					
51 V—350 V	—10% +100%					
351 V—450 V	—10% + 50%					
C5801	285-557	5 μ f	EMT	150 v		
C5802	285-557	5 μ f	EMT	150 v		
C5824	283-000	.001 μ f	Discap	500 v	GMV	
C5836	283-001	.005 μ f	Discap	500 v	GMV	
C5845	283-004	.02 μ f	Discap	150 v	GMV	
C5855	283-010	.05 μ f	Discap	50 v		
C5872	283-003	.01 μ f	Discap	150 v	GMV	
C5878	285-559	.1 μ f	PTM	50 v		
C5886	281-500	2.2 μ mf	Cer.	500 v	$\pm 0.5 \mu$ mf	
C5888	281-537	.68 μ mf	Cer.	500 v	$\pm 0.136 \mu$ mf	
C5890	285-559	.1 μ f	PTM	50 v		
C5896	281-500	2.2 μ mf	Cer.	500 v	$\pm 0.5 \mu$ mf	
C5898	281-537	.68 μ mf	Cer.	500 v	$\pm 0.136 \mu$ mf	
C6807	283-000	.001 μ f	Discap	500 v	GMV	
C6809	283-000	.001 μ f	Discap	500 v	GMV	
C6815	283-001	.005 μ f	Discap	500 v	GMV	
C6820	283-002	.01 μ f	Discap	500 v	GMV	
C6822	283-001	.005 μ f	Discap	500 v	GMV	
C6832	290-074	2000 μ f	EMC	20 v		
C6836	283-000	.001 μ f	Discap	500 v	GMV	X559-up
C6840	283-010	.05 μ f	Discap	50 v		
C6845	290-100	50 μ f	EMT	25 v		101-1000
	290-015	100 μ f	EMT	25 v		1001-up
C6847	285-557	5 μ f	PMC	150 v		
C6852	290-049	1000 μ f	EMC	15 v		
C6856	283-000	.001 μ f	Discap	500 v	GMV	X559-up
C6860	283-010	.05 μ f	Discap	50 v		
C6865	290-099	100 μ f	EMT	15 v		101-1000
	290-015	100 μ f	EMT	25 v		1001-up
C6872	290-049	1000 μ f	EMC	15 v		
C6882	290-090	2000 μ f	EMC	20 v		
C6883	283-000	.001 μ f	Discap	500 v	GMV	101-558X
C6886	290-101	250 μ f	EMT	6 v		
C6888	283-010	.05 μ f	Discap	50 v		

Diodes

D5803	152-047	Silicon Diode	1N2862 (or equal)
D6832 A, B	152-047	Silicon Diode	1N2862 (or equal)
D6852 A, B	152-047	Silicon Diode	1N2862 (or equal)
D6872 A, B, C, D	152-047	Silicon Diode	1N2862 (or equal)

Inductors

Circuit No.	Tektronix Part No.	Description	Serial No.
L5802	*108-151	3.2 μ h	
L5803	*108-153	6000 μ h	
L5804	*114-113	6-10 μ h	Var. core 276-511
L5812	*114-113	6-10 μ h	Var. core 276-511
L5884	*108-152	Plate Line	
L5894	*108-152	Plate Line	
L6807	*108-009	.18 μ h	
L6809	*108-009	.18 μ h	

Resistors

Resistors are fixed, composition, $\pm 10\%$ unless otherwise indicated.

R5801	307-025	3.3 Ω	$\frac{1}{2}$ w		
R5802	307-024	2.7 Ω	$\frac{1}{2}$ w		
R5803	307-025	3.3 Ω	$\frac{1}{2}$ w		
R5804	307-024	2.7 Ω	$\frac{1}{2}$ w		
R5808	309-112	100 Ω	$\frac{1}{2}$ w	Prec.	1%
R5810 A	309-212	47 Ω	$\frac{1}{2}$ w	Prec.	1%
R5810 B	309-219	95.5 Ω	$\frac{1}{2}$ w	Prec.	1%
R5810 C	309-221	241 Ω	$\frac{1}{2}$ w	Prec.	1%
R5810 D	309-222	484 Ω	$\frac{1}{2}$ w	Prec.	1%
R5810 E	309-223	966 Ω	$\frac{1}{2}$ w	Prec.	1%
R5810 F	309-224	2424 Ω	$\frac{1}{2}$ w	Prec.	1%
R5810 G	309-225	4850 Ω	$\frac{1}{2}$ w	Prec.	1%
R5810 H	309-226	9.7 k	$\frac{1}{2}$ w	Prec.	1%
R5811	307-025	3.3 k	$\frac{1}{2}$ w		
R5812	307-024	2.7 Ω	$\frac{1}{2}$ w		
R5815 A	309-220	97 Ω	$\frac{1}{2}$ w	Prec.	1%
R5815 B	309-218	60.6 Ω	$\frac{1}{2}$ w	Prec.	1%
R5815 C	309-217	53.9 Ω	$\frac{1}{2}$ w	Prec.	1%
R5815 D	309-216	50.9 Ω	$\frac{1}{2}$ w	Prec.	1%
R5815 E	309-215	49.5 Ω	$\frac{1}{2}$ w	Prec.	1%
R5815 G	309-213	48.75 Ω	$\frac{1}{2}$ w	Prec.	1%
R5815 F	309-214	49 Ω	$\frac{1}{2}$ w	Prec.	1%
R5820 A	309-128	50 Ω	$\frac{1}{2}$ w	Prec.	1%
R5820 B	309-211	150 Ω	$\frac{1}{2}$ w	Prec.	1%
R5820 C	309-210	450 Ω	$\frac{1}{2}$ w	Prec.	1%
R5820 D	309-209	950 Ω	$\frac{1}{2}$ w	Prec.	1%
R5820 E	309-208	1950 Ω	$\frac{1}{2}$ w	Prec.	1%
R5820 F	309-239	4950 Ω	$\frac{1}{2}$ w	Prec.	1%
R5820 G	309-205	9950 Ω	$\frac{1}{2}$ w	Prec.	1%
R5820 H	309-206	19.95 k	$\frac{1}{2}$ w	Prec.	1%
R5825	316-102	1 k	$\frac{1}{4}$ w		
R5826	316-104	100 k	$\frac{1}{4}$ w		
R5828	302-272	2.7 k	$\frac{1}{2}$ w		
R5830	316-101	100 Ω	$\frac{1}{4}$ w		
R5832	306-223	22 k	2 w		

Resistors (continued)

Circuit No.	Tektronix Part No.	Description	Serial No.
R5834	302-333	33 k 1 w	
R5836	316-561	560 Ω 1/4 w	
R5838	316-101	100 Ω 1/4 w	
R5840	302-272	2.7 k 1/2 w	
R5842	316-101	100 Ω 1/4 w	
R5845	316-105	1 meg 1/4 w	
R5850 A, B	309-058	2 x 2 Ω 1/2 w	Prec. 1%
R5850 C, D	309-058	2 x 2 Ω 1/2 w	Prec. 1%
R5850 E	309-059	3 Ω 1/2 w	Prec. 1%
R5850 F	309-127	5 Ω 1/2 w	Prec. 1%
R5850 G	309-096	10 Ω 1/2 w	Prec. 1%
R5850 H	309-233	30 Ω 1/2 w	Prec. 1%
R5850 J	309-128	50 Ω 1/2 w	Prec. 1%
R5850 K	309-112	100 Ω 1/2 w	Prec. 1%
R5852	301-752	7.5 k 1/2 w	5%
R5854	301-750	75 Ω 1/2 w	5%
R5855	302-181	180 Ω 1/2 w	
R5865	311-034	500 k 2 w	Var. POSITION
R5866	302-105	1 meg. 1/2 w	
R5870	311-034	500 k 2 w	Var. Pos. Range Adjust
R5871	302-684	680 k 1/2 w	
R5872	302-562	5.6 k 1/2 w	
R5877	302-105	1 meg 1/2 w	
R5878	302-105	1 meg 1/2 w	
R5879	302-271	270 Ω 1/2 w	
R5883	302-470	47 Ω 1/2 w	
R5884 †	use *310-551	500 Ω 1/2 w	Mica Plate 2% 101-1049
	*310-551	515 Ω 1/2 w	Mica Plate 2% 1050-up
R5885	311-056	500 Ω .10 w	Var. Gain Adj.
R5886	316-823	82 k 1/4 w	
R5887	304-393	39 k 1 w	
R5888	316-822	8.2 k 1/4 w	
R5890	302-105	1 meg 1/2 w	
R5891	302-105	1 meg 1/2 w	
R5893	302-470	47 Ω 1/2 w	
R5894 †	use *310-551	500 Ω 1/2 w	Mica Plate 2% 101-1049
	*310-551	515 Ω 1/2 w	Mica Plate 2% 1050-up
R5895	306-822	8.2 k 2 w	
R5896	316-823	82 k 1/4 w	
R5897	304-393	39 k 1 w	
R5898	316-822	8.2 k 1/4 w	
R5899	302-562	5.6 k 1/2 w	
R6800	316-470	47 Ω 1/4 w	
R6801	316-470	47 Ω 1/4 w	
R6803	303-822	8.2 k 1 w	5%
R6804	303-822	8.2 k 1 w	5%
R6805	304-182	1.8 k 1 w	
R6807	303-822	8.2 k 1 w	5%
R6808	311-120	2.5 k .2 w	Var. H.F. Peaking
R6809	303-822	8.2 k 1 w	5%

† S/N 101-1049 R5884 and R5894 should be replaced at the same time.

Resistors (continued)

Circuit No.	Tektronix Part No.	Description			Serial No.
R6815	316-101	100 Ω	1/4 w		
R6818	308-025	20 k	10 w	WW	5%
R6820	308-062	3 k	5 w	WW	5%
R6833	302-104	100 k	1/2 w		101-1000
	302-224	220 k	1/2 w		1001-up
R6834	302-154	150 k	1/2 w		
R6835	302-102	1 k	1/2 w		X559-up
R6837	308-141	1 Ω	1/2 w	WW	5%
R6838	302-333	33 k	1/2 w		
R6840	302-121	120 Ω	1/2 w		101-1000
	301-121	120 Ω	1/2 w		5% 1001-up
R6841	311-141	2 k		Var. WW 5%	COLLECTOR SOURCE VOLTS
R6842	308-105	30 k	8 w	WW	5%
	308-027	30 k	10 w	WW	5%
	305-113	11 k	2 w		5%
R6843	305-183	18 k	2 w		5% X1421-up
R6845	302-473	47 k	1/2 w		
R6853	302-104	100 k	1/2 w		101-1000
	302-224	220 k	1/2 w		1001-up
R6854	302-154	150 k	1/2 w		
R6855	302-102	1 k	1/2 w		X559-up
R6857	308-141	1 Ω	1/2 w	WW	5%
R6858	301-753	75 k	1/2 w		5%
R6859	311-056	500 Ω	.10 w	Var.	Pulse Volts Adj.
use	311-155	500 Ω	.2 w	Var.	
	311-155	1 k		Var.	
R6860	use 309-103	1.19 k	1/2 w		Prec. 1%
	309-103	808 Ω	1/2 w		Prec. 1%
R6861	use 311-141	2 k	2 w	Var.	WW 5%
	311-141	2 k		Var.	WW 5%
R6862	310-113	72 k	1 w		Prec. 1%
R6865	302-473	47 k	1/2 w		
R6876	308-054	10 k	5 w	WW	5%
R6877	307-025	3.3 Ω	1/2 w		
R6883	302-333	33 k	1/2 w		
R6884	302-333	33 k	1/2 w		
R6885	302-222	2.2 k	1/2 w		X559-up
R6886	302-101	100 Ω	1/2 w		
R6887	307-025	3.3 Ω	1/2 w		
R6890	309-172	78 Ω	1/2 w	Prec.	1%
R6891	309-244	133 Ω	1/2 w	Prec.	1%
R6893	310-067	28.05 k	1 w		
R6894 †	311-122	2 k	1/2 w	Var.	Prec. WW 1% Bias Volts
R6895	310-071	18.03 k	1 w		Prec. 1%
R6897	302-101	100 Ω	1/2 w		
R6898	302-683	68 k	1/2 w		

Switches

Circuit No.	Tektronix Part No.		Description	Serial No.
	Unwired	Wired		
SW5803	260-250		MERCURY	
SW5810	*260-222	*262-184	Rotary PULSE VOLTS	
SW5820	*260-224	*262-186	Rotary SERIES RESISTOR	
SW5824	*260-145		Rotary TRIGGER	
SW5850	*260-223	*262-185	Rotary COLLECTOR CURRENT MA/CM	
SW5870	260-228		Push Button	
SW5880	260-228		Push Button PULSE ZERO TIME REF.	
SW6841	260-212		Slide POLARITY	
SW6861	260-212		Slide POLARITY	
SW6894 †	*260-225	*262-187	Rotary BIAS VOLTS	

Transformers

T6830	*120-113	L.V. Power
-------	----------	------------

Electron Tubes

V5833	154-039	12AT7
V5834	154-040	12AU6
V5844	154-040	12AU6
V5884	154-040	12AU6
V5894	154-040	12AU6
V6803	154-039	12AT7

Transistors

Q6832	050-038	2N544	X1001-1555
	151-048	2N1632	1556-up
Q6833	151-007	2N270	X1001-up
Q6837	use 151-001	2N307	101-159
	151-001	2N301	160-up
Q6853	151-007	2N270	X1001-up
Q6854	050-038	2N544	X1001-1555
	151-048	2N1632	1556-up
Q6857	use 151-001	2N307	101-1000
	151-001	2N301	1001-up
Q6877	use 151-001	2N307	101-1000
	151-001	2N301	1001-up
Q6883	050-038	2N544	X1001-1555
	151-048	2N1632	1556-up
Q6884	151-005	2N212	X1001-up
Q6887	use 151-001	2N307	101-1000
	151-001	2N301	1001-up

† Concentric with SW6894. Furnished as a unit.

† Concentric with R6894. Furnished as a unit.

Type R

Mechanical Parts List

	Tektronix Part Number
BOLT, SPADE 6-32 x $\frac{3}{8}$ SN 101-1509	214-012
BRACKET, ALUM. .080 x 1 x $1\frac{1}{4}$ x $\frac{1}{2}$	406-230
BRACKET, ALUM. .063 x $1\frac{3}{16}$ x $1\frac{5}{16}$ x $1\frac{17}{32}$ SN 101-1509	406-386
BRACKET, ALUM. .063 x $\frac{3}{4}$ x $\frac{7}{8}$ x $\frac{1}{2}$	406-392
BUSHING, BANANA JACK	358-054
CABLE, HARNESS, POWER SN 101-1420	179-250
CABLE, HARNESS, POWER SN 1421-up	179-453
CABLE, HARNESS, REGULATOR SN 101-1000	179-251
CABLE, HARNESS, REGULATOR SN 1001-1420	179-314
CABLE, HARNESS, REGULATOR SN 1421-up	179-454
CHASSIS, POWER	441-208
CHASSIS, REGULATOR SN 101-1000	441-209
CHASSIS, REGULATOR SN 1001-up	441-239
CLAMP, CABLE $\frac{3}{16}$ Plastic SN 101-1719	343-002
CLAMP, CABLE $\frac{1}{8}$ Plastic SN 1720-up	343-001
CLAMP, STAINLESS STEEL, $\frac{1}{2}$ x $\frac{3}{4}$ Dia.	343-036
CLAMP, MOUNTING FOR TRANSISTOR SN 1001-1555	343-044
CLAMP, TRANSISTOR MTG., $\frac{1}{4}$ x $\frac{1}{4}$ SN 1556-up	343-068
CLIP, FUSE $\frac{1}{4}$ "	344-002
CLIP, ALLIGATOR w/o eyelet	344-004
CLIP, ALLIGATOR ASS'Y	344-005
CONNECTOR, CHASSIS MT., 16-contact, male	131-017
COUPLING, POT, WIRE STEEL	376-014
EYELET, BRASS TAPERED BARREL	210-601
GROMMET, RUBBER $\frac{1}{4}$ SN 1001-up	348-002
GROMMET, RUBBER $\frac{5}{16}$ SN 101-1420	348-003
GROMMET, RUBBER $\frac{3}{8}$	348-004
GROMMET, RUBBER $\frac{1}{2}$	348-005
HOLDER, NYLON $\frac{3}{16}$ x $\frac{3}{4}$ tapped 4-40 (for coil form)	352-015
KNOB, LARGE BLACK 1.225 flange $\frac{1}{4}$ insert hole	366-028
KNOB, LARGE BLACK 1.225 flange $\frac{1}{4}$ insert hole $\frac{1}{4}$ conc. hole	366-029
KNOB, SMALL RED	366-031
KNOB, SMALL BLACK	366-033
KNOB, PLUG-IN SECURING	366-125
LOCKWASHER, STEEL INT. #4	210-004
LOCKWASHER, STEEL INT. #6	210-006

Mechanical Parts List (continued)

	Tektronix Part Number
LOCKWASHER, STEEL INT. #8	210-008
LOCKWASHER, STEEL INT. 1/4	210-011
LOCKWASHER, STEEL INT. POT, 3/8 x 1/2	210-012
LOCKWASHER, STEEL No. 5, spring	210-018
LUG, SOLDER SE4	210-201
LUG, SOLDER SE6	210-202
LUG, SOLDER POT, PLAIN, 3/8	210-207
LUG, SOLDER 1/4" lock-lug	210-223
NUT, HEX 4-40 x 3/16	210-406
NUT, HEX 6-32 x 3/16	210-407
NUT, HEX 8-32 x 5/16	210-409
NUT, HEX 3/8-32 x 1/2	210-413
NUT, KEPS 6-32 x 5/16	210-457
NUT, HEX 1/4-32 x 3/8 x 3/32 (for miniature pot)	210-465
NUT, HEX 6-32 x 5/16 x .194 (5-10 w res. mtg.)	210-478
PANEL, FRONT	333-450
PLATE, PLEXIGLAS .100 x 1 3/4 x 3, Cap. Mtg.	386-978
PLATE, WIRED Grounded Emitter Socket	386-852
PLATE, WIRED Grounded Base Socket	386-853
PLATE, SUB PANEL	386-819
PLATE, FRAME BACK	387-529
PLUG, BANANA Male, white teflon	134-033
POST, TERMINAL Transistor mtg., 10-32 x 5/16 x 7/32 SN 101-1000	129-043
POST, TERMINAL Transistor mtg., .094 x 3/16 hex 3/16 x 1/4 SN 1001-up	129-049
RING, RETAINING #18 Securing	354-025
RING, SECURING Poly., 1/2 x 9/16 x 1/2 SN 1001-up	354-068
RODS, EXTENSION 1/8 x 4 3/32	384-174
RODS, FRAME 3/8 x 8 7/8, tapped 8-32	384-508
RODS, SECURING 3/16 x 10 1/2	384-510
RODS, SPACING ALUM., 1/4 x 3 1/4 tapped 6-32 SN 1390-up	384-518
SCREW 4-40 x 1/4 BHS	211-008
SCREW 4-40 x 5/16 BHS	211-011
SCREW 4-40 x 1 1/4 RHS	211-021
SCREW 4-40 x 1/4 FHS	211-023
SCREW 6-32 x 1/4 BHS	211-504
SCREW 6-32 x 5/16 BHS	211-507

Mechanical Parts List (continued)

	Tektronix Part Number
SCREW 6-32 x 3/8 FHS	211-509
SCREW 6-32 x 3/8 BHS	211-510
SCREW 6-32 x 1/2 BHS	211-511
SCREW 6-32 x 5/16 PAN HS w/lockwasher	211-534
SCREW 6-32 x 5/16 FHS 100°, CSK, Phillips	211-538
SCREW 6-32 x 5/16 RHS	211-543
SCREW 6-32 x 1 1/2 RHS, Phillips	211-553
SCREW 8-32 x 1/2 FHS, Phillips	212-043
SCREW 8-32 x 1/2 RHS, Phillips	212-044
SCREW, THREAD CUTTING, 5-32 x 3/16 PAN H STEEL, Phillips	213-044
SCREW, SELF-TAPPING, 4-40 x 5/16 PAN H STEEL, Phillips	213-045
SHIELD 1/32 x 1 1/4 dia. oval	337-124
SHIELD .020 x 1 9/16 x 2 9/16 x 1 1/2, atten.	337-268
SOCKET STM7G	136-008
SOCKET STM9G	136-015
SOCKET, TRANSISAR, 4 pin w/flat saddle SN 101-1000	136-050
SPACER, NYLON, 1/16 (for ceramic strip)	361-007
SPACER, NYLON, 5/16 (for ceramic strip)	361-009
STRIP, CERAMIC, 3/4 x 2 notches, clip mounted	124-086
STRIP, CERAMIC, 3/4 x 4 notches, clip mounted	124-088
STRIP, CERAMIC, 3/4 x 7 notches, clip mounted	124-089
STRIP, CERAMIC, 3/4 x 9 notches, clip mounted	124-090
STRIP, CERAMIC, 3/4 x 11 notches, clip mounted	124-091
STUD, NYLON, MOLDED .510 x .277 x .128 (for ceramic strip) SN1001-up	355-046
TUBE, SPACING, ALUM. 5/32 x 1"	166-136
TUBING, PLASTIC INSUL. #7 clear	162-012
TUBING, PLASTIC INSUL. #20 black (skein)	162-504
TUBING, PLASTIC INSUL. #24 black	162-505
WASHER, STEEL 6S x 5/16 x .028	210-802
WASHER, STEEL 6L x 3/8 x .032	210-803
WASHER, STEEL .039 x 9/16 x .020	210-840
WASHER, POLY .190 x 7/16 x 1/32	210-894
WASHER, BAKELITE .129 x 1/2 Shoulder 3/8 Transistor Mtg.	210-900

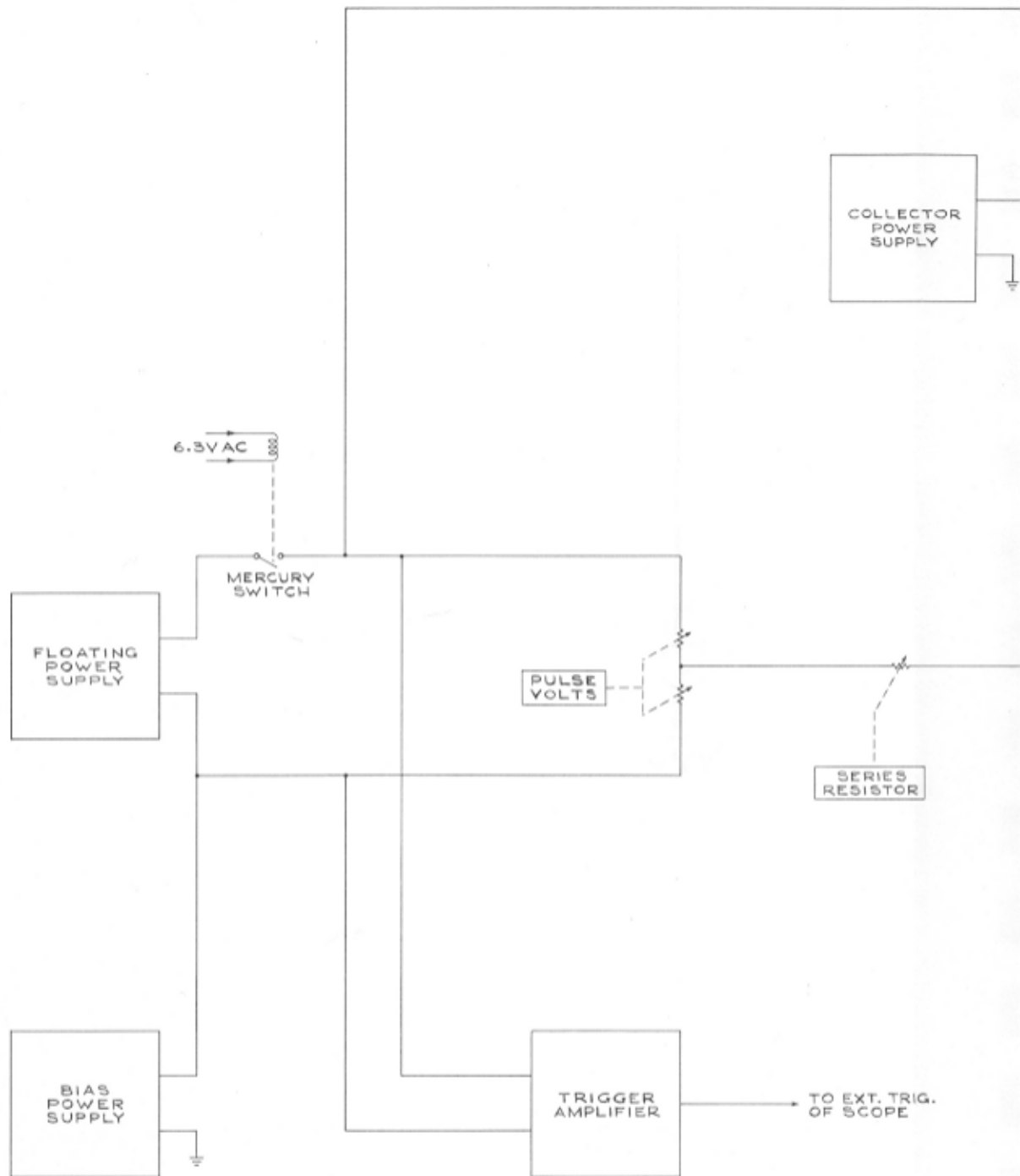

TYPE R PLUG-IN UNIT

AA

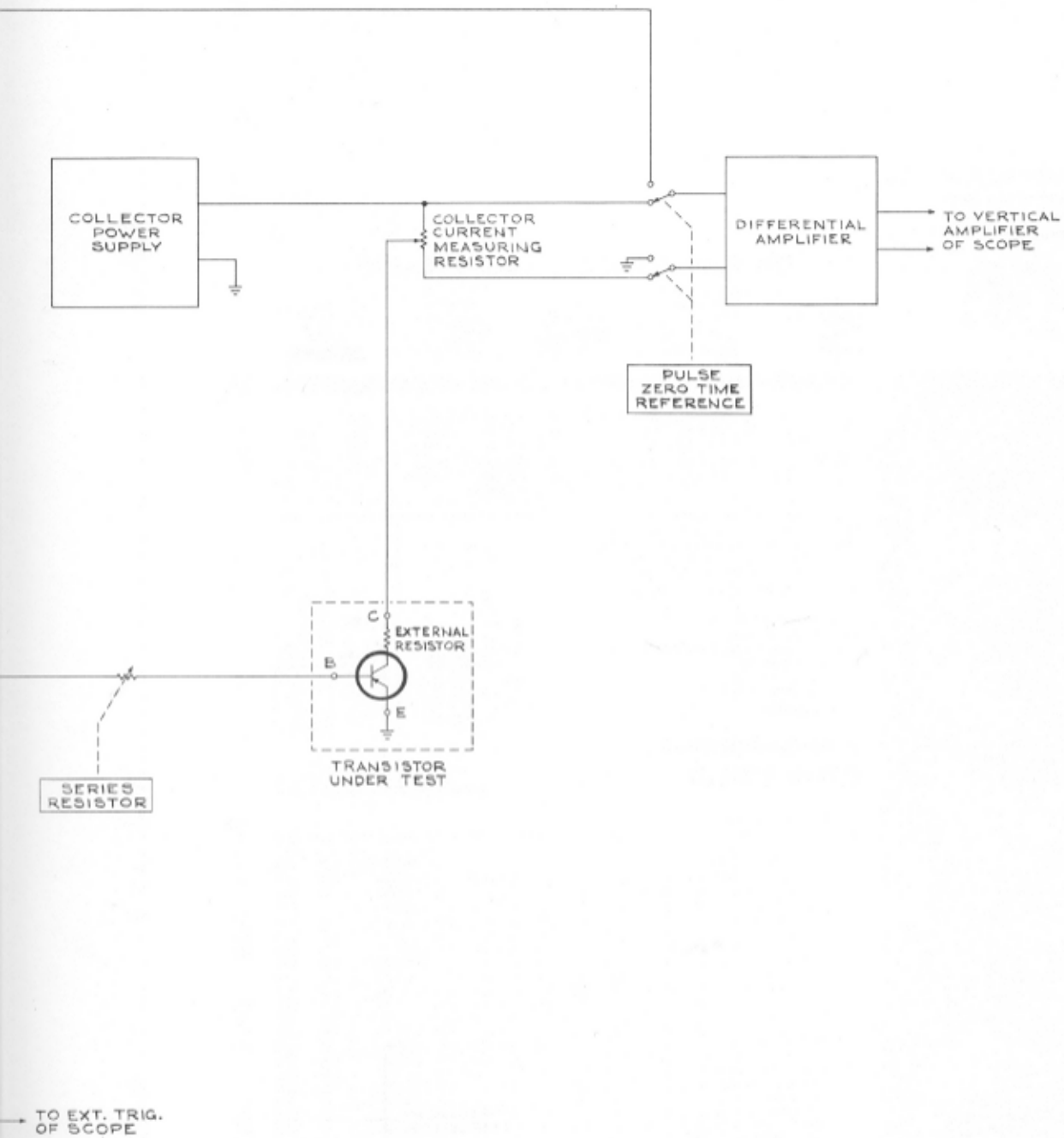

REC
5-8-61

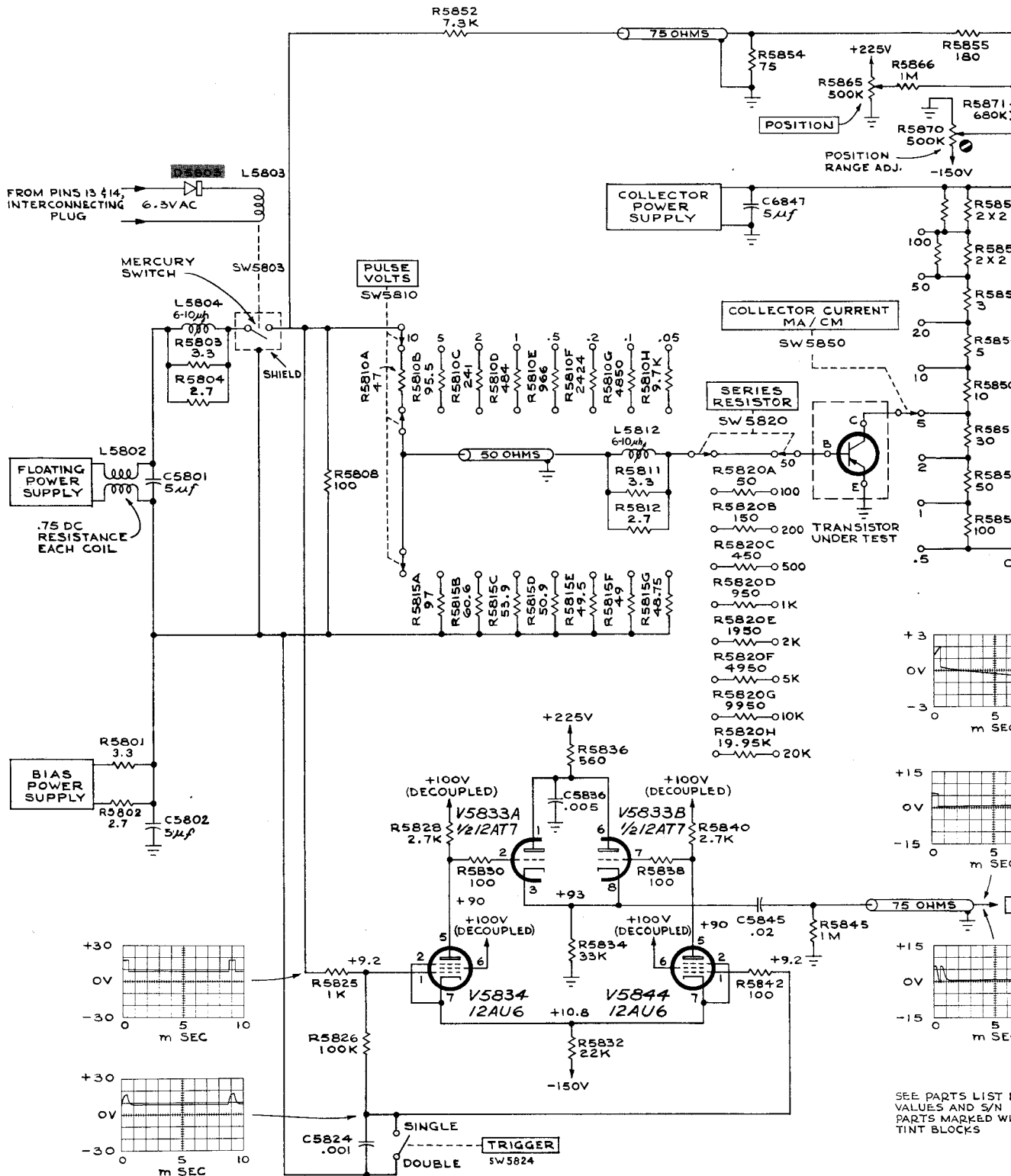

TYPE R PLUG-IN UNIT

AA7

PUL

+

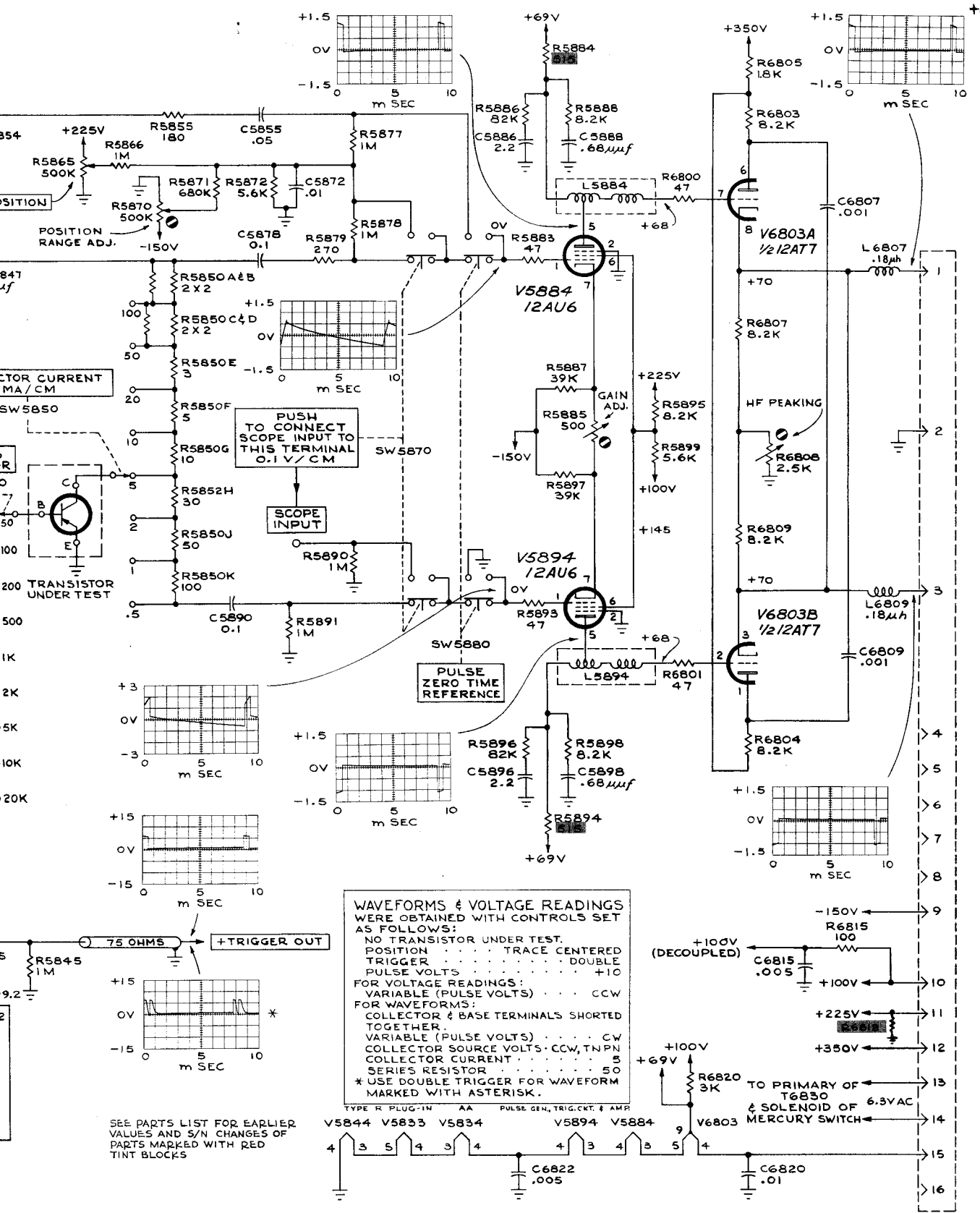

WAVEFORMS & VOLTAGE READINGS WERE OBTAINED WITH CONTROLS SET AS FOLLOWS:
 NO TRANSISTOR UNDER TEST.
 POSITION TRACE CENTERED
 TRIGGER DOUBLE
 PULSE VOLTS +10
 FOR VOLTAGE READINGS:
 VARIABLE (PULSE VOLTS) CCW
 FOR WAVEFORMS:
 COLLECTOR & BASE TERMINALS SHORTED TOGETHER.
 VARIABLE (PULSE VOLTS) CW
 COLLECTOR SOURCE VOLTS CCW, TNPN
 COLLECTOR CURRENT 5
 SERIES RESISTOR 50
 * USE DOUBLE TRIGGER FOR WAVEFORM MARKED WITH ASTERISK.

SEE PARTS LIST FOR EARLIER VALUES AND S/N CHANGES OF PARTS MARKED WITH RED TINT BLOCKS

PULSE GENERATOR, TRIGGERING CIRCUIT, & AMPLIFIER

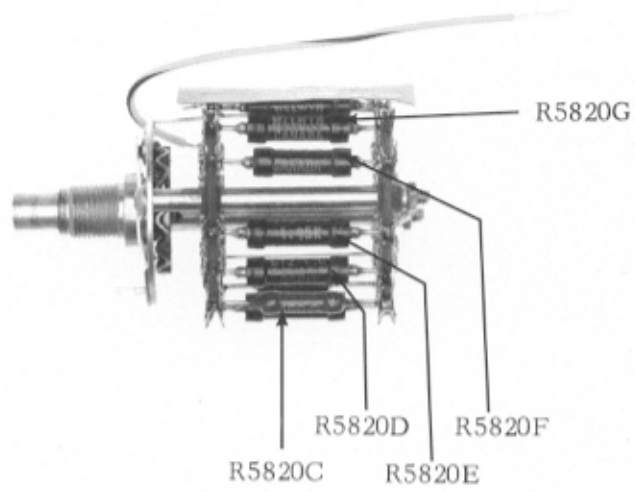

Type R TOP VIEW SERIES RESISTOR A

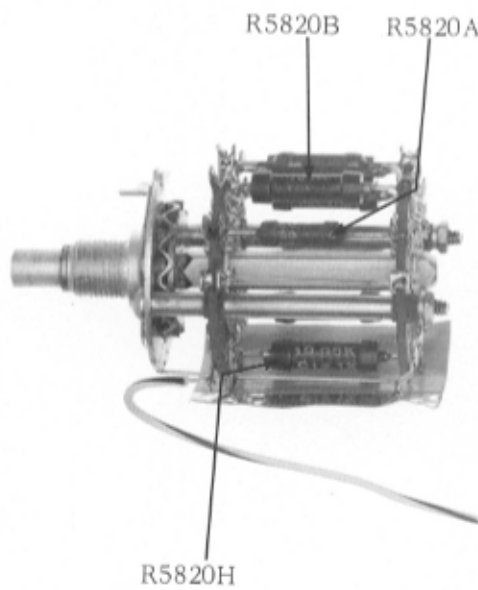

Type R BOTTOM VIEW SERIES RESISTOR A

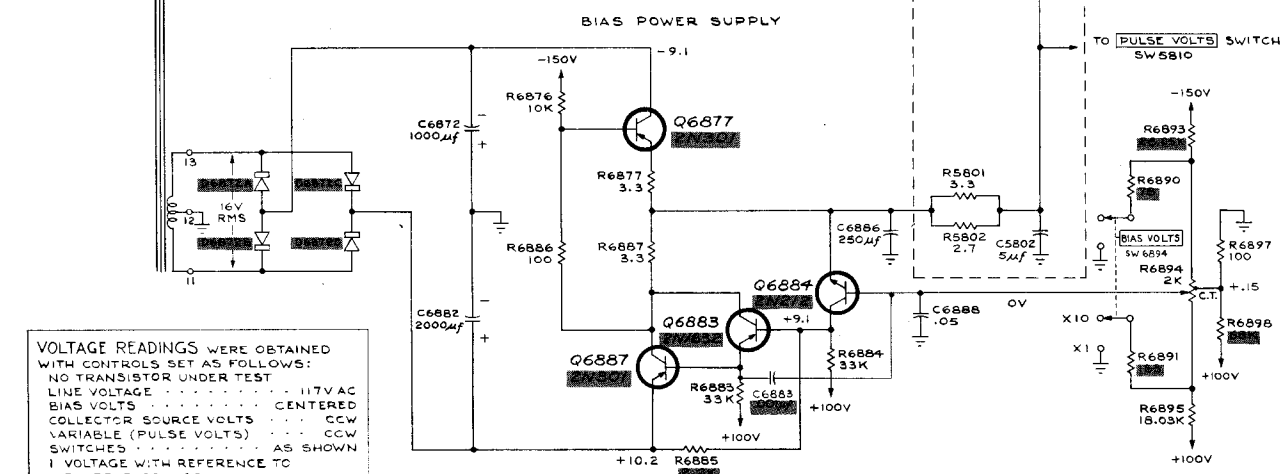
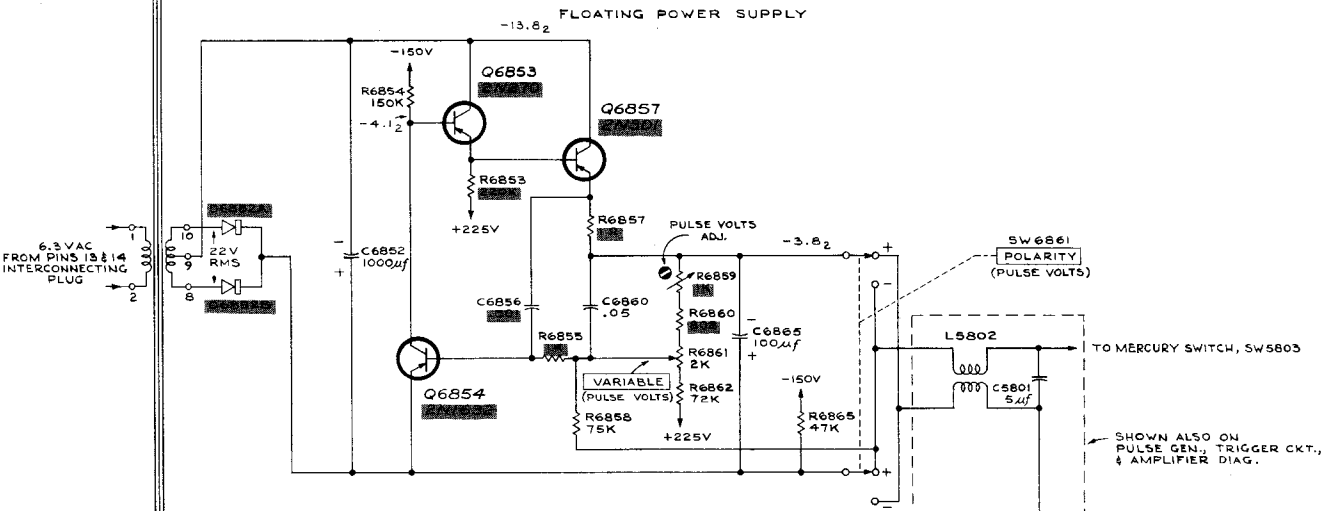
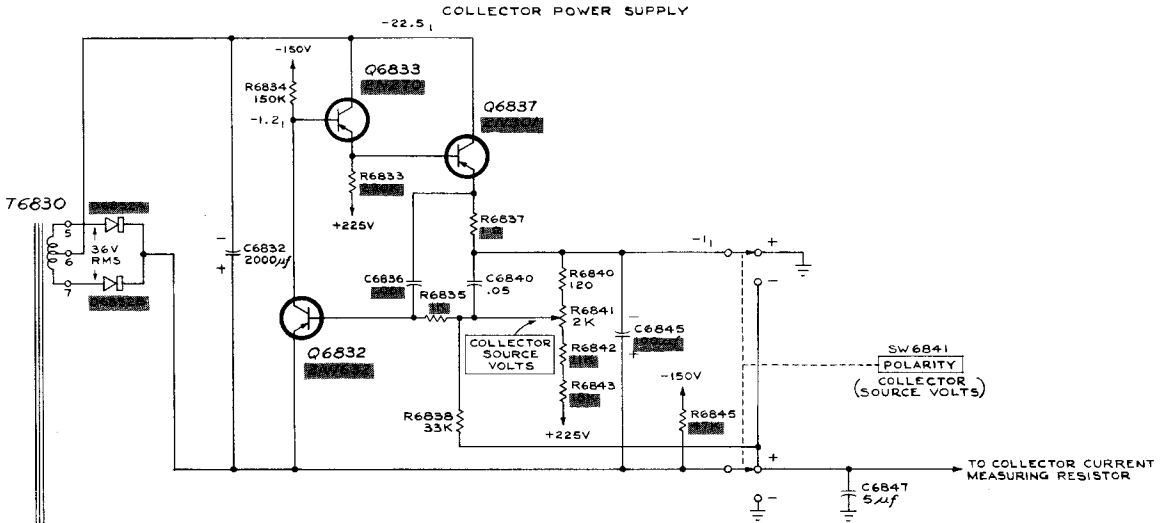

VOLTAGE READINGS WERE OBTAINED WITH CONTROLS SET AS FOLLOWS:
 NO TRANSISTOR UNDER TEST
 LINE VOLTAGE 117V AC
 BIAS VOLTS CENTERED
 COLLECTOR SOURCE VOLTS CCW
 VARIABLE (PULSE VOLTS) CCW
 SWITCHES AS SHOWN
 1 VOLTAGE WITH REFERENCE TO EMITTER OF Q6832
 2 VOLTAGE WITH REFERENCE TO EMITTER OF Q6854

SEE PARTS LIST FOR EARLIER VALUES AND S/N CHANGES OF PARTS MARKED WITH RED TINT BLOCKS

MRH
2-7-62

TYPE R PLUG-IN UNIT

AA 4

POWER SUPPLY

MANUAL CHANGE INFORMATION

At Tektronix, we continually strive to keep up with latest electronic developments by adding circuit and component improvements to our instruments as soon as they are developed and tested.

Sometimes, due to printing and shipping requirements, we can't get these changes immediately into printed manuals. Hence, your manual may contain new change information on following pages. If it does not, your manual is correct as printed.

MOD 6860

Type R - Tent S/N 2600

Type S - Tent S/N 1150

Cable, Trigger Assy. Change to 93 Ω BNC 175-276

K4XL's **BAMA**

This manual is provided **FREE OF CHARGE** from the "BoatAnchor Manual Archive" as a service to the Boatanchor community.

It was uploaded by someone who wanted to help you repair and maintain your equipment.

If you paid anyone other than BAMA for this manual, you paid someone who is making a profit from the free labor of others without asking their permission.

You may pass on copies of this manual to anyone who needs it. But do it without charge.

Thousands of files are available without charge from BAMA. Visit us at <http://bama.sbc.edu>